

SAVANNAH RIVER SITE COLD WAR HISTORIC PROPERTY DOCUMENTATION

NARRATIVE AND PHOTOGRAPHY

400/D AREA – HEAVY WATER PRODUCTION

Aiken County, South Carolina



Report Prepared By
New South Associates
6150 East Ponce de Leon Avenue
Stone Mountain, Georgia 30083

SAVANNAH RIVER SITE COLD WAR HISTORIC PROPERTY DOCUMENTATION

NARRATIVE AND PHOTOGRAPHY

400/D AREA – HEAVY WATER PRODUCTION

Aiken County, South Carolina

Report submitted to:

Westinghouse Savannah River Company • Aiken, SC

Report prepared by:

New South Associates • 6150 East Ponce de Leon Avenue • Stone Mountain, Georgia 30083

Mary Beth Reed

Mark T. Swanson

March 14, 2008 • Final Report

New South Associates Technical Report No. 1568

ABSTRACT

This report is a thematic study of buildings and facilities constructed at Savannah River Site to produce heavy water in the 400/D Area. It was prepared in accordance with a Memorandum of Agreement (MOA) signed by the Department of Energy–Savannah River (DOE-SR) and the South Carolina State Historic Preservation Office (SHPO) dated February 27, 2003, as well as the Consolidated MOA of August 2004. The MOA stipulated that a thematic study and photographic documentation be produced that told the story of D Area’s genesis, its operational history, and its closure. D Area, also known as the 400 Area, was the site of the Savannah River’s heavy water production facilities constructed as part of the Savannah River Site (SRS) between 1950 and 1955. Heavy water was integral to the Site’s Cold War nuclear production mission as it was used to moderate and cool the five production reactors that operated at Savannah River. The study provides historic contexts for the site’s Cold War history and a context for heavy water production based on primary and secondary research and oral history. Documentation photography is provided in Appendix B .

ACKNOWLEDGEMENTS

A number of individuals have contributed to this effort. First and foremost, Tom Feske with WSRC was instrumental in getting the SRS Cold War preservation effort off the ground. Tom's vision was the beginning and Linda Perry, also with WSRC, helped to get the program off the ground. John Knox, Dennis Godsbbee, both with the Department of Energy Savannah River (DOE-SR), worked with Tom and Linda on the other side of the fence to make that vision work. This group participated in the preparation of the MOA that required this study and later the SRS Cold War Historic Properties Programmatic Agreement that allows the Site to better manage its historic properties. Currently, Nick Delaplane with DOE-SR and Theresa Haas and Paul Sauerborn with WSRC manage the Cold War Preservation Program. Thanks to all involved.

Photography and the scanning of photography were handled by the talented staff at Site Photo Services. Thanks to Steve Ashe, Bruce Bolineau, Tom Kotti and Byron Williams. Tracey Fedor at New South designed the volume, making our work look good as always.

Finally, we thank the men and women who provided us with their memories of Savannah River Site: Dr. William P. Bebbington, Mr. Mitch Burgess, Mr. Don Duarte, Mr. Lee Poe, Mr. Richard Shulko and Ms. Elsie Wood Smith. Their words make it come alive.

TABLE OF CONTENTS

| | |
|--|-----|
| ABSTRACT..... | II |
| ACKNOWLEDGEMENTS..... | III |
| TABLE OF CONTENTS..... | IV |
| ACRONYM LIST..... | IX |
| | |
| I. INTRODUCTION..... | 1 |
| SRS COLD WAR HISTORIC DISTRICT AND ITS SIGNIFICANCE..... | 1 |
| DOCUMENT ORGANIZATION..... | 7 |
| | |
| II. SAVANNAH RIVER SITE COLD WAR CONTEXT..... | 9 |
| COLD WAR DEFENSE MISSION..... | 9 |
| THE MANHATTAN PROJECT..... | 11 |
| ONSET OF THE COLD WAR..... | 13 |
| SAVANNAH RIVER PLANT AS PART OF THE BIG PICTURE..... | 15 |
| SAVANNAH RIVER PROJECT, 1950-1955..... | 16 |
| DU PONT SIGNS ON..... | 17 |
| SITE SELECTION..... | 18 |
| ANNOUNCEMENT..... | 20 |
| SITE DESCRIPTION..... | 21 |
| SITE LAYOUT..... | 23 |
| SUBCONTRACTORS..... | 26 |
| UNFOLDING SCOPE OF WORK AND FLEXIBLE DESIGN..... | 28 |

| | |
|---|----|
| SRP OPERATIONS, 1955 - 1989 | 28 |
| HEAVY WATER PRODUCTION AND REWORK..... | 29 |
| FUEL AND TARGET FABRICATION | 30 |
| REACTOR OPERATIONS..... | 31 |
| SEPARATIONS | 32 |
| WASTE MANAGEMENT..... | 33 |
| RESEARCH, DEVELOPMENT, AND TESTING..... | 33 |
| DEVELOPMENT OF PEACEFUL USE OF ATOMIC ENERGY, AND ITS IMPACT ON SRP | 37 |
| ENVIRONMENTALISM, EXPANSION, AND CHANGE AT SAVANNAH RIVER | 39 |
| RISE OF ENVIRONMENTALISM..... | 40 |
| REACTOR UPGRADES, L-RESTART, 700 AREA EXPANSION, AND CLOSE OF HEAVY WATER FACILITIES | 41 |
| DEFENSE WASTE PROCESSING FACILITY (DWPF) AND NAVAL FUELS PROGRAM..... | 44 |
| REACTOR SHUTDOWNS AND DU PONT’S DEPARTURE..... | 45 |
| END OF COLD WAR..... | 46 |
| III. EARLY HEAVY WATER RESEARCH | 49 |
| IV. DANA PLANT..... | 55 |
| HEAVY WATER PRODUCTION AT DANA | 58 |
| SAVANNAH RIVER JOINS DANA..... | 60 |
| V. 400/D CONSTRUCTION | 63 |

| | |
|--|----|
| AREA LAYOUT AND MAJOR FACILITIES | 71 |
| BUILDING DESCRIPTIONS | 73 |
| HYDROGEN SULFIDE PLANT (401-D) | 75 |
| TANK FARM (402-D) | 76 |
| GS UNITS (411-D, 412-D, 413-D)..... | 77 |
| FLARE TOWER (419-D) | 80 |
| CONCENTRATOR (420-D)..... | 82 |
| FINISHING BUILDING (421-D)..... | 83 |
| CYLINDER LOADING (421-1D AND 421-2D) | 85 |
| WATER FILTRATION AND TREATMENT PLANT (483-D, 483-2D, 483-3D) | 86 |
| AREA GATE HOUSE AND PATROL HEADQUARTERS (701-1D)..... | 87 |
| GATE HOUSE (701-2D) | 87 |
| GATE HOUSE (701-3D) | 90 |
| SUPERVISOR’S OFFICE AND FIRST AID (704-D) | 90 |
| CHANGE HOUSE (707-D)..... | 91 |
| FIREHOUSE (709-D)..... | 92 |
| STEEL AND PIPE STORAGE (711-D) | 93 |
| SHOPS, STORES AND CHANGE HOUSE (717-D) | 93 |
| CONTROL LABORATORY AND SUPERVISOR’S OFFICE (772-D)..... | 94 |
| SUMMARY | 96 |

| | |
|--|-----|
| VI. OPERATIONS | 99 |
| DANGERS AND HAZARDS | 99 |
| WORKFORCE | 102 |
| PRODUCTION | 104 |
| “ITS PRODUCTS GO FAR” | 107 |
| HEAVY WATER TECHNOLOGY AND EXPERTISE..... | 109 |
| | |
| VII. CLOSURE..... | 111 |
| | |
| VIII. INSIDE PERSPECTIVES | 113 |
| <i>TERRIBLE HAUTE, BUBBLE CAP TOWERS, AND ROTTEN EGGS</i> (DON DUARTE)..... | 113 |
| <i>NOW, WHATEVER YOU DO, DON'T LET THEM SEND YOU TO 400 AREA...</i> - ELSIE WOOD SMITH | 117 |
| <i>FIRST OFF, I AM, OR WAS, A CHEMICAL ENGINEER...</i> (WILLIAM P. BEBBINGTON) | 122 |
| THE BUDDY SYSTEM, PROCEDURES AND AQUA (MITCH BURGESS) | 125 |
| IMPROVING THE PROCESS (RICHARD SHULKO)..... | 127 |
| YOUR JOB DEPENDED ON IT (LEE POE)..... | 129 |
| | |
| ENDNOTES | 135 |
| | |
| GLOSSARY..... | 143 |
| | |
| SUGGESTED READING | 151 |

| | |
|---|-----|
| APPENDIX A- ORAL HISTORY TRANSCRIPTIONS | 159 |
| WILLIAM BEBBINGTON..... | 161 |
| MITCH BURGESS | 173 |
| DON DUARTE | 181 |
| LEE POE | 189 |
| RICHARD SHULKO..... | 201 |
| ELSIE WOOD SMITH | 209 |
| | |
| APPENDIX B - AS-BUILT DRAWINGS AND MITIGATION PHOTOGRAPHY | 225 |
| 420-D CONCENTRATOR..... | 227 |
| 420-2D REWORK HANDLING FACILITY..... | 255 |
| 421-D FINISHING BUILDING..... | 265 |
| 421-2D CYLINDER LOADING | 291 |
| 483-D WATER FILTRATION AND TREATMENT PLANT..... | 301 |
| 483-2D CHEMICAL FEED BUILDING..... | 323 |
| 483-3D CHEMICAL FEED BUILDING..... | 329 |
| 701-1D AREA GATE HOUSE AND PATROL HEADQUARTERS..... | 335 |
| 701-2D GATE HOUSE | 347 |
| 701-3D GATE HOUSE | 353 |
| 704-D SUPERVISOR’S OFFICE AND FIRST AID | 359 |
| 717-D SHOPS, STORES & CHANGE HOUSE..... | 373 |
| 772-D CONTROL LABORATORY AND SUPERVISOR’S OFFICE..... | 389 |

ACRONYM LIST

| | |
|----------|---|
| ACHP | ADVISORY COUNCIL ON HISTORIC PRESERVATION |
| AMCP | ASSISTANT MANAGER FOR CLOSURE PROJECTS |
| AM&F | AMERICAN MACHINE AND FOUNDRY |
| AEC | ATOMIC ENERGY COMMISSION |
| AEC SROO | ATOMIC ENERGY COMMISSION SAVANNAH RIVER OPERATIONS OFFICE |
| AED | ATOMIC ENERGY DIVISION – DU PONT COMPANY |
| AOE | ASSESSMENT OF EFFECT |
| | |
| CAB | SAVANNAH RIVER SITE CITIZEN’S ADVISORY BOARD |
| CERCLA | COMPREHENSIVE ENVIRONMENTAL RESPONSE, COMPENSATION, AND LIABILITY ACT |
| CFR | CODE OF FEDERAL REGULATIONS |
| CNTA | CITIZENS FOR NUCLEAR TECHNOLOGY AWARENESS |
| COE | U. S. ARMY CORPS OF ENGINEERS |
| CRM | CULTURAL RESOURCE MANAGEMENT |
| CRMP | CULTURAL RESOURCE MANAGEMENT PLAN |
| CSRA | CENTRAL SAVANNAH RIVER AREA |
| | |
| DECP | DECOMMISSIONING PROJECT (DOE-SR) |
| D&D | DEACTIVATION AND DECOMMISSIONING |
| DOD | DEPARTMENT OF DEFENSE |
| DOE | U. S. DEPARTMENT OF ENERGY |
| DOE | DETERMINATION OF ELIGIBILITY |
| DOE FPO | U. S. DEPARTMENT OF ENERGY FEDERAL PRESERVATION OFFICER |
| DOE-SR | U. S. DEPARTMENT OF ENERGY SAVANNAH RIVER |
| DWPF | DEFENSE WASTE PROCESSING FACILITY |
| | |
| ECS | EMERGENCY COOLING SYSTEMS |
| EM | ENVIRONMENTAL MANAGEMENT |
| EOC | EMERGENCY OPERATIONS CENTER – SRS |
| EPA | U. S. ENVIRONMENTAL PROTECTION AGENCY |
| ERDA | ENERGY RESEARCH AND DEVELOPMENT ADMINISTRATION |
| | |
| FFA | FEDERAL FACILITIES AGREEMENT |
| FRA | FEDERAL RECORDS ACT |
| | |
| GS | GIRDLER SYSTEM, GIRDLER SULFIDE |
| | |
| HABS | HISTORIC AMERICAN BUILDINGS SURVEY |
| HAER | HISTORIC AMERICAN ENGINEERING RECORD |
| HWCTR | HEAVY WATER COMPONENTS TEST REACTOR |
| | |
| INL | IDAHO NATIONAL LABORATORY |
| IRM | INFORMATION RESOURCE MANAGEMENT DEPARTMENT - SRS |
| | |
| JCAE | JOINT COMMITTEE ON ATOMIC ENERGY |
| | |
| LANL | LOS ALAMOS NATIONAL LABORATORY |
| LTBT | LIMITED TEST BAN TREATY |
| LTR | LATTICE TEST REACTOR |
| | |
| MED | MANHATTAN ENGINEERING DISTRICT |
| MOA | MEMORANDUM OF AGREEMENT |
| MPPF | MULTI-PURPOSE PROCESSING FACILITY |
| | |
| NARA | NATIONAL ARCHIVES RECORDS ADMINISTRATION |
| NASA | NATIONAL AERONAUTICS AND SPACE ADMINISTRATION |

| | |
|--------|---|
| NEPA | NATIONAL ENVIRONMENTAL POLICY ACT |
| NHL | NATIONAL HISTORIC LANDMARK |
| NHPA | NATIONAL HISTORIC PRESERVATION ACT |
| NNSA | U. S. DEPARTMENT OF ENERGY NATIONAL NUCLEAR SECURITY ADMINISTRATION |
| NPS | NATIONAL PARK SERVICE |
| NPT | NON-PROLIFERATION TREATY |
| NRC | NUCLEAR REGULATORY COMMISSION |
| NRHP | NATIONAL REGISTER OF HISTORIC PLACES |
| NTG | NEUTRON TEST GAGE |
| NURE | NATIONAL URANIUM RESOURCES EVALUATION |
| NYX | NEW YORK SHIPBUILDING COMPANY |
| ORA | OPERATIONS RECREATION ASSOCIATION |
| ORNL | OAK RIDGE NATIONAL LABORATORY |
| PA | PROGRAMMATIC AGREEMENT |
| PDP | PROCESS DEVELOPMENT PILE |
| PSE | PRESSURIZED SUB-CRITICAL EXPERIMENT |
| RBOF | RECEIVING BASIN FOR OFFSITE FUEL |
| RTR | RESONANCE TEST REACTOR |
| SALT | STRATEGIC ARMS LIMITATION TREATY |
| SCDAH | SOUTH CAROLINA DEPARTMENT OF ARCHIVES AND HISTORY |
| SCDHEC | SOUTH CAROLINA DEPARTMENT OF HEALTH AND ENVIRONMENTAL CONTROL |
| SCIAA | SOUTH CAROLINA INSTITUTE OF ARCHAEOLOGY AND ANTHROPOLOGY |
| SDI | STRATEGIC DEFENSE INITIATIVE |
| SE | SUB-CRITICAL EXPERIMENT (EXPONENTIAL TANK) |
| SHPO | STATE HISTORIC PRESERVATION OFFICE/OFFICER |
| SHRINE | SAVANNAH RIVER INFORMATION NETWORK ENVIRONMENT |
| SP | STANDARD PILE |
| SRARP | SAVANNAH RIVER ARCHAEOLOGICAL RESEARCH PROGRAM |
| SRI | SAVANNAH RIVER NATURAL RESOURCE MANAGEMENT AND RESEARCH INSTITUTE |
| SRL | SAVANNAH RIVER LABORATORY |
| SREL | SAVANNAH RIVER ECOLOGY LABORATORY |
| SRNL | SAVANNAH RIVER NATIONAL LABORATORY |
| SROO | SAVANNAH RIVER OPERATIONS OFFICE |
| SRP | SAVANNAH RIVER PLANT |
| SRS | SAVANNAH RIVER SITE |
| SRSO | U. S. DEPARTMENT OF ENERGY-SAVANNAH RIVER SITE OFFICE |
| SRSOC | SAVANNAH RIVER SITE OPERATIONS CENTER |
| SRTC | SAVANNAH RIVER TECHNOLOGY CENTER |
| STI | SCIENTIFIC AND TECHNOLOGICAL INFORMATION |
| TC | TEMPORARY CONSTRUCTION |
| TCAP | THERMAL CYCLING ABSORPTION PROCESS |
| TRAC | TRACKING ATMOSPHERIC RADIOACTIVE CONTAMINANTS |
| TTBT | THRESHOLD TEST BAN TREATY |
| UCNI | UNCLASSIFIED CONTROLLED NUCLEAR INFORMATION |
| UGA | UNIVERSITY OF GEORGIA |
| USC | UNIVERSITY OF SOUTH CAROLINA |
| USFS | U. S. FOREST SERVICE |
| USH | UNIVERSAL SLEEVE HOUSING |
| VWF&S | VOORHEES, WALKER, FOLEY AND SMITH |
| WIND | WEATHER INFORMATION AND DISPLAY SYSTEM |
| WSRC | WESTINGHOUSE SAVANNAH RIVER COMPANY |

I. INTRODUCTION

This documentation was prepared in accordance with a Memorandum of Agreement (MOA) signed by the Department of Energy–Savannah River (DOE-SR) and the South Carolina State Historic Preservation Office (SHPO) dated February 27, 2003, as well as the Consolidated MOA of August 2004. The MOA stipulated that a thematic study and photographic documentation be produced that told the story of D Area’s genesis, its operational history, and its closure. D Area, also known as the 400 Area, was the site of the Savannah River’s heavy water production facilities constructed as part of the Savannah River Site (SRS) between 1950 and 1955. Heavy water was integral to the Site’s Cold War nuclear production mission as it was used to moderate and cool the five production reactors that operated at Savannah River.

Preceded by the Atomic Energy Commission’s Dana Plant in Indiana, D Area would eclipse Dana in size and production in 1957 after which it operated exclusively as the nation’s sole heavy water producer until 1987. Its emblematic multiple tiers of distillation towers that resembled refinery “architecture” were removed and sold as excess after the area had produced sufficient heavy water to meet production needs at SRS. Built with urgency, creativity, and care, the 400/D Area has a unique place in the nation’s nuclear weapons production history as well as a pivotal role at the Site.

SRS was known as the Savannah River Plant (SRP) until 1989. The impetus for the study was the imminent decommissioning of D Area facilities that had survived until that year. Many D Area facilities had already been decommissioned in the 1980s before their historical significance was recognized. Thus the heavy water area was more of an industrial archaeological site than an intact building area. The remaining heavy water production facilities are considered eligible for listing on the National Register of Historic Places (NRHP) as contributing resources to a proposed SRS Cold War Historic District established after inventory and evaluation of the Site’s Cold War resources.

SRS is located on 198,344 acres in Aiken, Barnwell, and Allendale counties of South Carolina. The Savannah River is its western border. The rural site comprises roughly one percent of the state of South Carolina and contains approximately 310 square miles within the upper coastal plain of the state. Historically, the area that became the Site was mostly agricultural and its current physical setting remains fairly rural. The county seat of Aiken County, the city of Aiken, lies 12 miles to the north; the Augusta, Georgia metropolitan area lies 15 miles to the northwest. The cities of Jackson and New Ellenton are located on the site’s northern perimeter. SRS is considered to be part of the 18-county Central Savannah River Area (CSRA) adjoining the Savannah River in both South Carolina and Georgia.

SRS Cold War Historic District and its Significance

The Savannah River Site is an exceptionally important historic resource containing information about our nation’s twentieth-century Cold War history. It contains a well-preserved group of buildings and structures placed within a carefully defined site plan that are historically linked, sharing a common designer and aesthetic. The site layout, predicated on environmental safety best practice in 1950 and a functional industrial approach, is intact. The site,

■ Demolished
■ Mitigated Resources
■ Resources Documented Under Separate Thematic Study

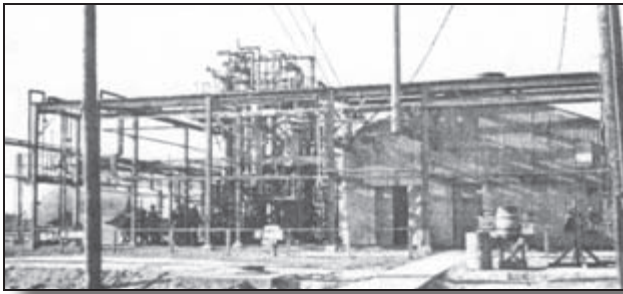

401-D

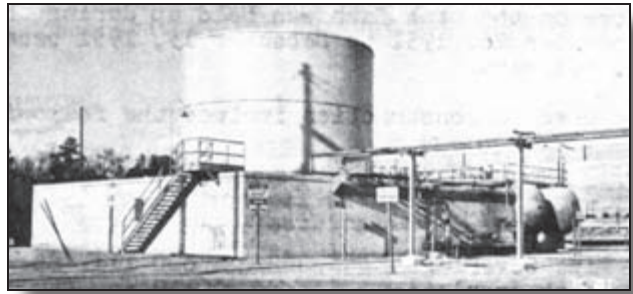

402-D



411-413 GS Units and Flare Tower



420-D



420-2D



421-D



421-1D



421-2D



451-D



483-D



484-D



614-1D



701-D



701-2D



701-3D



704-D



707-D



711-D



717-D



772-D

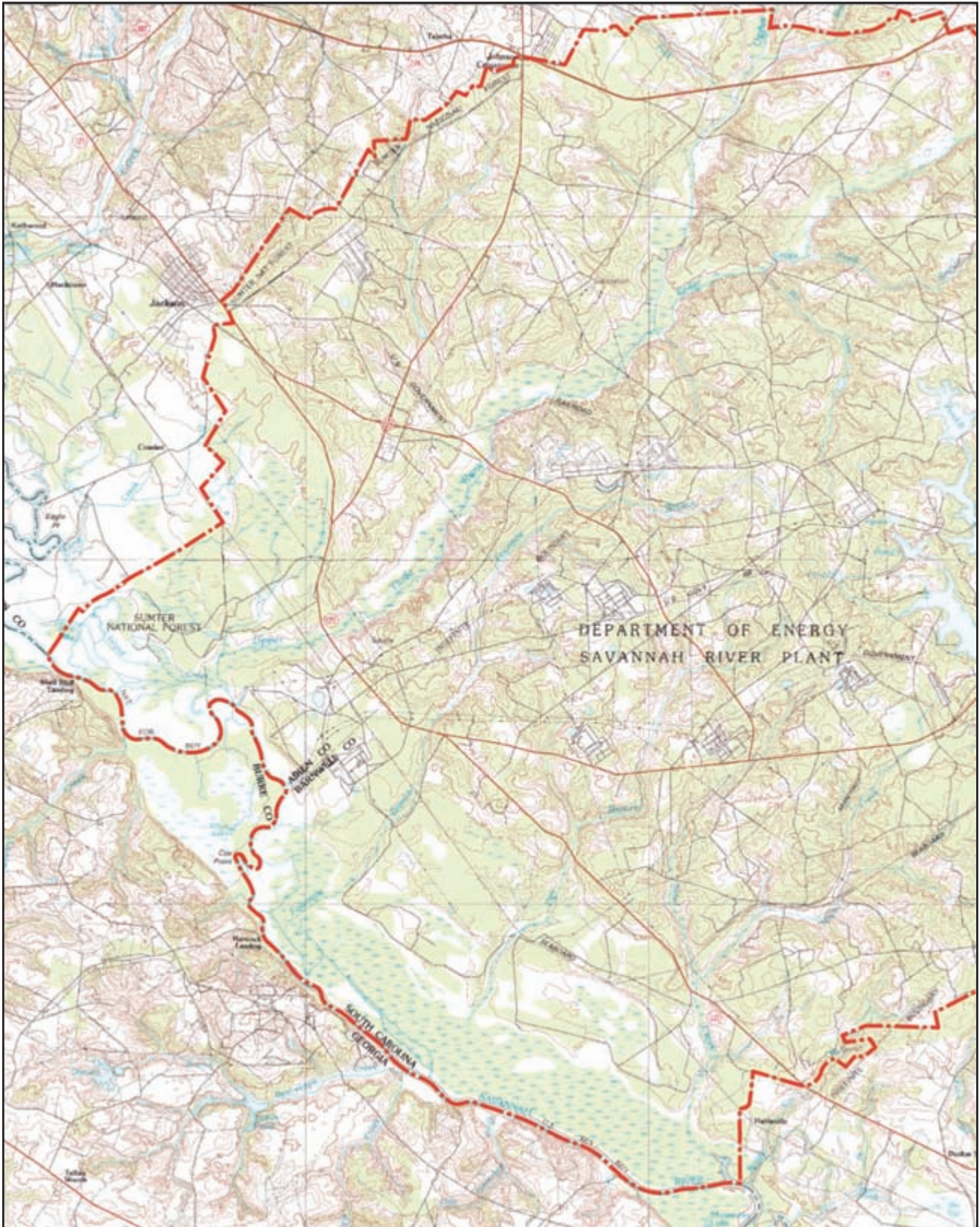

SRS Location Map

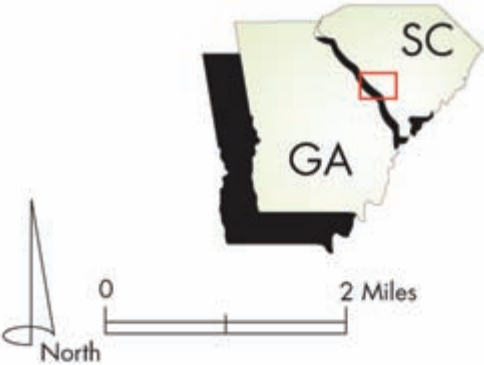

Source: USGS 30X60 Minute Quadrangle; Barnwell, S.C., GA., 1982.



its buildings, structures and its layout, constitute a unique cultural landscape that possesses historical significance on a national, state and local level in the areas of engineering, military, industry, and social history. The Site is directly associated with the Cold War, a defining national historical event of the twentieth century that lasted over four decades. This association satisfies National Register Criteria A or the association of a property with events that have made a significant contribution to the broad patterns of our history. The Site's process and research facilities were also used to further research in pursuit of peaceful uses of atomic energy. The Transplutonium Programs, the discovery of the free neutrino, the production of plutonium-238 for heat sources, and the production of heavy water for research were all notable achievements. The Cold War and the development of atomic energy for weapons and for peaceful purposes have received considerable scholarly attention as definitive forces within twentieth-century American history.

The proposed Cold War district also satisfies National Register Criteria C as it embodies best practice principles of nuclear design and safety when constructed. It represents the work of a master in that Du Pont was the designer of the unique and unprecedented complex that required the simultaneous construction of five nuclear production reactors, two separation plants, an industrial size heavy water plant, and a fuel and target manufacturing plant. Du Pont was considered the single American firm with the capability to handle the enormous job entailed in the Site's construction and operation. While this facet of Criteria C is usually applied to an architect or architectural firm, it is appropriate here. Du Pont brought its unique corporate culture, management skills, adherence to flexible design and its deep atomic energy experience to the job. A letter from President Truman to Du Pont requesting they take on the project underscores the fact that Du Pont was considered uniquely qualified to build and operate the Savannah River Site.

The historic district is also considered eligible under Criteria C for the methods of construction used that involved flexible design, an innovative approach that was characteristic of Du Pont and its management style and that directly contributed to the Site's success. The proposed district's buildings and structures reflect unique architectural and engineering attributes that were consonant with their mission. These include unique construction materials, functional design, and special design criteria for radiological shielding, personnel safety, and the ability to sustain a military attack. The engineering required to bring the nine Savannah River plants online was innovative and was successfully completed under rigorous schedules unparalleled in our nation's twentieth-century history. For all the above reasons, the proposed Cold War District amply satisfies National Register Criteria C.

Savannah River Site's historic district may also fulfill National Register Criteria D, the potential to yield information in history. While this criteria is usually reserved for archaeological resources it is applicable here. Much of the historical data that elucidates Savannah River's full Cold War history is held as classified information. When these records are declassified and open to the American public, new information disclosed might yield important information about the Site's Cold War past that is unknown or imprudent to publicly release at this time.

While its national importance to the Cold War is evident, SRS also gains National Register standing for its impact on South Carolina as a whole and on the Central Savannah River Area (CSRA) as a region. The selection of the site along the Savannah River for the construction of what would be known as the Savannah River Plant had a profound impact on the state, although one less readily quantified. It shifted the image of South Carolina from that

of a rural agrarian state to one that was more progressive and industrialized. The training and inclusion of locals within the SRS' workforce demonstrated the ability of southerners to work within modern industrial highly technical facilities. Du Pont's management of this labor force, and the harmonious relations between races at the Site, further diminished northern concerns about establishing factories in the South. SRS' existence, and the efforts of local politicians, would result in additional nuclear facilities coming to the region. Interstate and regional pacts on nuclear topics were developed that would become models for interstate cooperation. The presence of SRS would begin to shift state University curriculums from solely an agricultural focus to a new emphasis on engineering, raised the hopes and self esteem of its citizens, and placed the state at the forefront of the march to a New Age. No other single construction, site or event would so affect South Carolina's history in the Cold War era, and the SRS derives National Register standing at the state level from this influence as well.

No other construction would so dramatically alter a region. By its very construction, the SRS rewrote the history of the CSRA. Communities, like Ellenton and Dunbarton, vanished in its wake, as did the rural areas that surrounded them. Other communities, like Aiken, changed almost overnight. As the first "open" nuclear site, the SRS brought an immigration of scientists and engineers the likes of which few regions in the nation would ever experience, changed the housing stock and appearance of the towns these atomic immigrants would move to, changed the make-up of their schools, political parties, and other social organizations, and rewrote local history. It is difficult to imagine anyone within the CSRA, if asked about the history of their region, not mentioning the SRS within their first thoughts and words. The SRS was extremely significant regionally as well as nationally and at the state level.

DOCUMENT ORGANIZATION

The MOA stipulated that a written narrative should be developed based on primary sources to the greatest extent possible, including but not limited to oral history, archival history, and drawings. A companion documentation mitigation strategy was further stipulated - capturing the buildings and its interior process areas using large format photography when intact interiors were present and 35 mm black and white photography for exterior photographic documentation and for interiors that had compromised historic integrity. New South Associates was responsible for the historical research, oral history and the compilation of a narrative. Westinghouse Savannah River Company (WSRC) was responsible for the photographic documentation, its archival processing, and its compilation.

This narrative provides an overview of the historic processes carried out in D Area, followed by specific building descriptions and photographic documentation. It is a section within a developing portfolio of similar studies that address the historic production mission of the Savannah River Site during the Cold War and its role during the Atoms for Peace Program.

After this introduction, there are six chapters. Chapter II gives a context for the site and its development. Chapter III is devoted to heavy water production prior to 1950 and the development of heavy water technology. Chapter

IV presents information on the Dana Plant. The following chapter deals with the construction phase and focuses upon the 400/D Area buildings and structures. An operational history is presented in Chapter VI, followed by a chapter that focuses upon the area's closure. Chapter VIII ends the document with excerpts from oral history interviews on Dana and 400/D Area.

For clarity, the 400 Area will be referred to as the 400/D Area in this document. This study does not include the power facilities in D Area that still remain in operation and are leased to South Carolina Electric and Gas Company (SCE&G). These will be fully documented in a thematic study devoted to site infrastructure. Finally, the monitoring building type was documented in the A Area thematic study, titled: *700/A Area Site Administration, Safety, Security and Support* completed in 2007.

II. SAVANNAH RIVER SITE COLD WAR CONTEXT

The SRS, built by E. I. Du Pont de Nemours and Company for the U.S. Atomic Energy Commission, had its origins in the early years of the Cold War as a facility for the production of plutonium and tritium, materials essential to the nation's nuclear arsenal. From the beginning, its mission was military. It was designed primarily to produce tritium, and secondarily to produce plutonium and other special materials as directed by the Department of Energy (DOE) and its precursor organizations, the Atomic Energy Commission (AEC) and the Energy Research and Development Administration (ERDA). Because of this mission, SRS has been an integral part of the nuclear weapons production complex. The production goal of the complex was to transform natural elements into explosive fissile materials, and to bring together fissile and non-fissile components in ways that would best meet the goal of Cold War deterrence. SRS provided most of the tritium and a large percentage of the plutonium needed for the production of fissile components from 1953 through 1988.

In addition to the Cold War defense mission, there was another, almost parallel, story of research and development using Site technologies and products for peaceful uses of atomic energy. Such government-sponsored research was strongly supported by the AEC, which was a civilian organization independent of military control. Although many of the non-defense programs conducted at SRS did not develop with the promise hoped for in the 1950s and 1960s, this was not for want of effort on the part of the AEC, Du Pont, or the scientists who helped operate SRS.

The two basic missions at SRS, nuclear materials production for defense, and production for non-defense programs, are explored in greater detail below. Both were considerable achievements. The defense mission produced much of the material required for the nuclear bombs and warheads constructed during the height of the Cold War. The non-defense programs generated new materials and increased the general knowledge of nuclear science.

COLD WAR DEFENSE MISSION

The defense mission of the SRP, as it was known prior to 1988, was an integral part of the AEC program to create weapons-grade plutonium and tritium for incorporation into fission and fusion bombs, known respectively as atomic and hydrogen bombs. The defense mission of SRP, and for that matter, the AEC, had its origins in the Manhattan Project, the World War II program that manufactured the world's first fission bombs, using both uranium and plutonium. It was the use of these devices against Japan in August 1945 that ended World War II, and ushered in the Atomic Age. The Manhattan Project, a vast and secret enterprise, set the tone for its successor, the AEC, even though the two were organized in different ways.

WE DON'T DIG URANIUM OUT OF THE GROUND,
AND WE DON'T MAKE BOMBS,
BUT WE DO NEARLY EVERYTHING IN BETWEEN.

PLANT PROCESSES

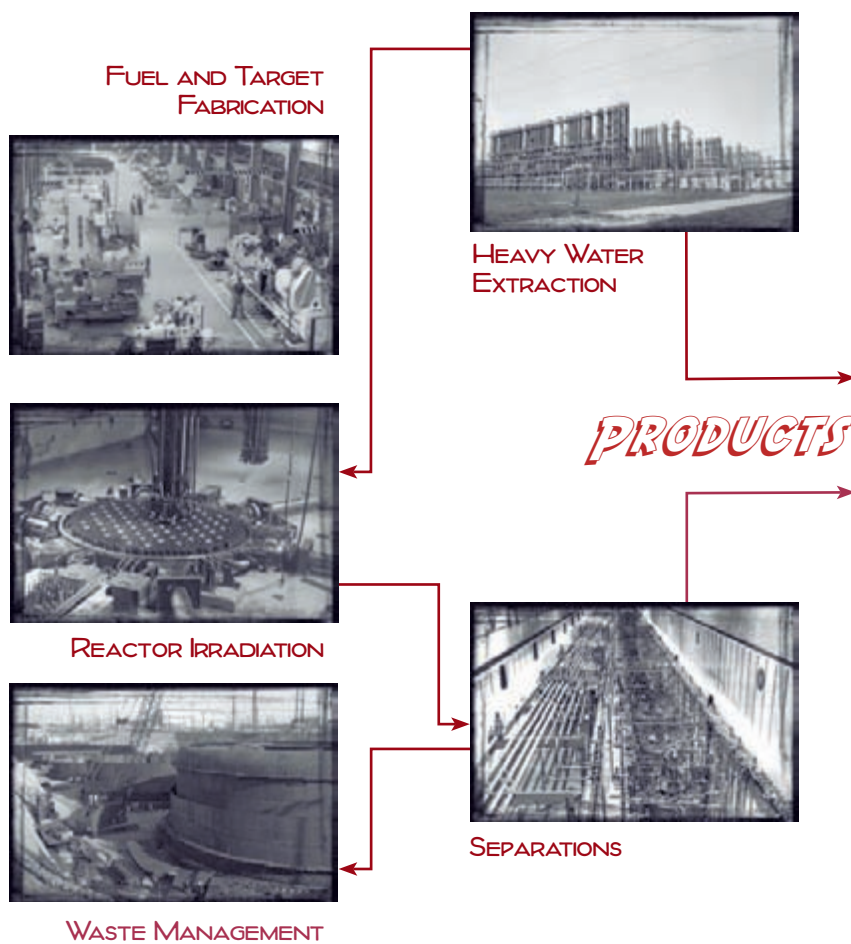

PLUTONIUM-238

Produced by neutron irradiation of neptunium-237, a byproduct of uranium irradiation. Valuable for its heat generating capacity.

CURIUM-244

Properties and applications similar to plutonium-238.

PLUTONIUM-239

Used as a nuclear explosive, a breeder reactor fuel, or as the starting target material for production of heavier radioisotopes.

TRITIUM (Hydrogen-3)

A radioactive isotope of hydrogen, component of thermonuclear explosives, and a potential fuel for thermonuclear fusion power generation.

COBALT-60

Known radiation source and has long been used for radiotherapy.

CALIFORNIUM-252

One of the rarest man-made isotopes, has great potential value in medicine, industry, research, and education.

HEAVY WATER (D₂O)

Important nonradioactive product of the Savannah River Plant. It occurs at a concentration of 0.015% in natural water and must be concentrated to 99+% to be useful in reactors as a neutron moderator.

AND OTHER RADIOACTIVE ISOTOPES

Depiction of Plant Processes and Products Compiled from Savannah River Laboratory's *Nucleonics of Tomorrow in the Making Here Today* (Aiken, South Carolina: E. I. Du Pont de Nemours and Company, not dated).

The Manhattan Project

The Manhattan Project, formally known as the Manhattan Engineer District (MED), was established in August of 1942, more than half a year after Pearl Harbor.¹ Its mission was to beat the Germans in what was widely assumed to be a race for the atom bomb.² Unlike other Army Corps of Engineers districts, the MED had no specific geographical boundaries and virtually no budget limitations. General Leslie Groves was put in charge of the operation, and he was allowed enormous leeway. As Groves himself would state after the war, he had the role of an impresario in “a two billion dollar grand opera with thousands of temperamental stars in all walks of life.”³ In organizing the MED, Groves established a precedent that would carry over to the AEC: scientific personnel and resources would be culled from the major universities, but production techniques would be obtained from corporations familiar with the assembly line.⁴ The Manhattan Project could not have succeeded without a willing army of brilliant physicists (many of whom were refugees from Hitler’s Europe), the nation’s huge industrial base of capital and personnel skills, and the leadership and construction skills provided by the Army Corps of Engineers.⁵



Commemorative Manhattan Project Button “A” Bomb Button. Courtesy of Oak Ridge National Laboratory.

The last half of 1942 saw the groundwork laid for the development of the Manhattan Project. Groves and others selected the methods and sites to be used to produce the bomb. For both speed and economy, Groves wanted to concentrate on one single method for bomb production, but science would not oblige.⁶ In the fall of 1942, there were a number of equally valid and equally untried methods for obtaining the fission material for an atomic bomb. There was even a choice of materials: uranium-235 and plutonium.



General Leslie Groves (left), Manhattan Engineer District Leader and Robert Oppenheimer (right), Scientist, Los Alamos.

The methods best known to the scientific community at the start of the Manhattan Project dealt with the collection of isotope uranium-235, which comprises only a very small percentage of natural uranium. There were at least four possible methods for removing uranium-235 from the matrix of natural uranium: the centrifuge method; thermal diffusion; gaseous diffusion; and electromagnetic separation.

To complicate matters, there was also a new method based on the production of a man-made element, plutonium, discovered and named by Glenn Seaborg and others in 1941. Plutonium could be produced by irradiating natural uranium in a pile or reactor, after which it could be separated from uranium chemically, something not possible with isotopes like uranium-235.⁷

By the end of 1942, the field was narrowed to three main methods in the race to produce nuclear materials: gaseous diffusion, electromagnetic separation, and plutonium production. In December 1942, when President Roosevelt gave his final approval for the all-out push, it was decided to proceed with all three.⁸ The last of

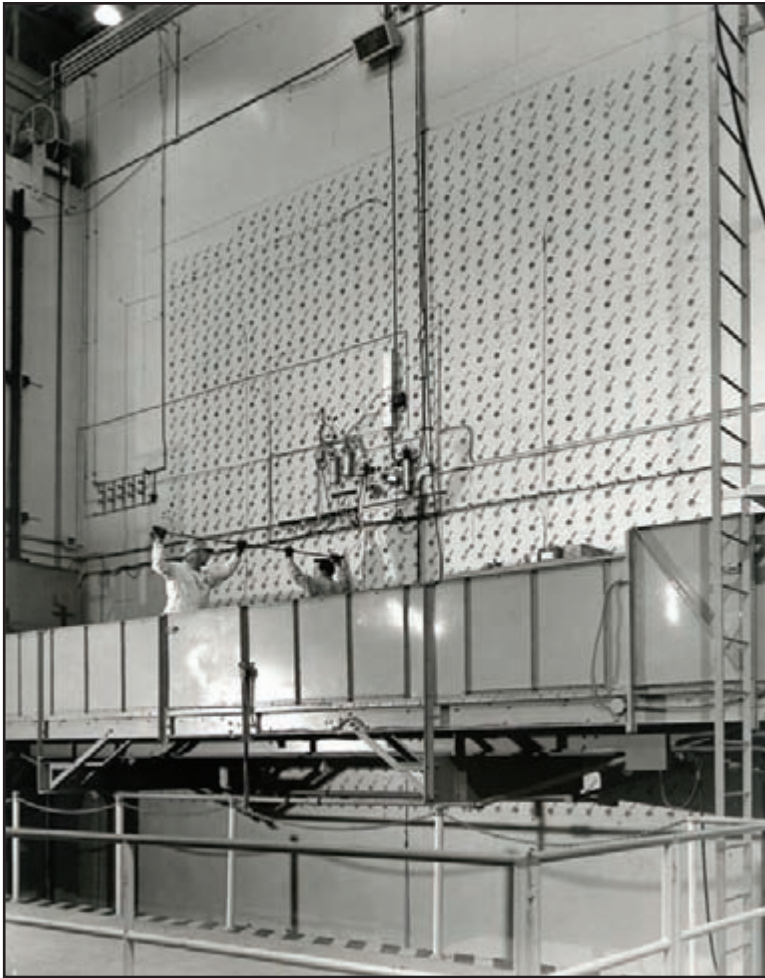

X-10 Pile Constructed by E. I. Du Pont de Nemours & Co. at Oak Ridge, Tennessee, now designated as a National Historic Landmark. Courtesy of Oak Ridge National Laboratory

these methods certainly got a boost on December 2, 1942, when Italian refugee Enrico Fermi, working at the University of Chicago, created the world's first self-sustaining chain reaction in a graphite reactor.⁹

By this time, three huge test and production sites had been selected for MED's work. The first was Oak Ridge in Tennessee, then known as "Clinton Engineer Works," selected as the site for a full-scale electromagnetic plant (Y-12), a gaseous diffusion plant (K-25), and a plutonium pile semi-works (X-10).¹⁰ Constructed in 1943, X-10 became the world's first production reactor when it went critical on November 4, 1943.¹¹ Hanford, in Washington State, was selected as the main plutonium production site, while Los Alamos in New Mexico, under the direction of Robert Oppenheimer, was chosen to be the nerve center of the project and the bomb assembly site.¹²

While Los Alamos may have been the center of the MED, Hanford was the key to the plutonium bomb, which required the new element in quantities unimaginable before the war. For the construction of the X-10 at Oak Ridge and the full-scale reactors to be built and operated at Hanford, Groves picked Du Pont. This was done not only because of Du Pont's history of explosives manufacture and its association with the U.S. military, but also because it was a large chemical firm that had the personnel, organization, and design capabilities required to do the job.¹³ Most importantly, it had a tradition of translating scientific ideas and laboratory techniques into assembly line production.¹⁴

To do so in a field of endeavor in which they were not expert, Du Pont was to depend heavily upon the Metallurgical Laboratory of the University of Chicago for nuclear physics and radiochemistry experience. Du Pont's key technical employees were sent to Chicago and to Clinton to learn from the research scientists about problems that would bear on the design and operation of the semi-works and the full-scale production plants. This dialogue between the industrial engineers and the academic scientists would be the basis for the selection of processes, and the design of the equipment needed to carry them out, at both the semi-works and at Hanford.¹⁵

Hanford's three reactors (B, D, and F) and two separations buildings were constructed in 1943-1944. The reactors, water-cooled and graphite-moderated, went on line between September 1944 and February 1945.¹⁶ One of the first crises in the plutonium program occurred shortly after the Hanford B reactor went critical in September 1944. The reactor would go critical and then shut down in a totally unexpected series of oscillations that threatened to ruin the production schedule. After frantic research, it was determined that the reaction had been killed by a periodic build-up of xenon that proved to be a huge neutron absorber with a nine-hour half-life.¹⁷ An engineering feature added by Du Pont was instrumental in solving the problem of xenon poisoning. When scientists at the University of Chicago's Metallurgy Laboratory insisted that only 1500 tube openings were needed in the reactor face, Du Pont added an additional 500 openings as a precaution. This spare capacity, built into every Hanford reactor, made it possible to load the extra openings and simply overpower the effect of the xenon.¹⁸

By early 1945, Hanford was shipping plutonium to Los Alamos for bomb assembly work.¹⁹ With a detonation device based on implosion, which was more complicated than that required for the uranium bomb, the plutonium bomb had to be tested near Alamogordo, New Mexico, in July 1945. One month later, a similar device was dropped on Nagasaki, only three days after the uranium bomb was dropped on Hiroshima.

The Manhattan Project had been a purely military undertaking, conceived and successfully concluded as a top-secret operation of the Second World War. In the year that followed the war, the project began to unravel as top scientists and others left the project to return to civilian life, and the government considered different proposals for dealing with the awesome power that had ended the war.

Onset of the Cold War

Relations between the United States and the Soviet Union, guarded during WWII, began to chill in the aftermath. The Cold War had its "official" beginnings in February and March of 1946, with three critical events. The first was Stalin's speech (February 9) to Communist Party stalwarts, reaffirming the Party's control over the Soviet Union, and promising more five-year plans and an arms race to overtake the capitalist powers. This was followed on February 22 by George Kennan's famous telegram describing the expansionist worldview of the Soviet leadership, and suggesting "containment" as the best solution. Last but certainly not least, on March 5, was Churchill's "Iron Curtain" speech at Fulton, Missouri.²⁰

The beginnings of the Cold War in early 1946 quickly derailed initial talk of international control of atomic energy. By the time the AEC was created by Congress in the summer of 1946, atomic energy had become the cornerstone of the nation's defense against the Soviet Union's preponderance in conventional land forces. For this reason, President Truman was shocked to discover that when the AEC took over Los Alamos in early 1947, the United States did not possess a single assembled working bomb.²¹

Between 1947 and 1950, during the chairmanship of David Lilienthal, the main mission of the AEC was the re-establishment of the nation's nuclear arsenal. The AEC was created as an umbrella agency to control all of the nation's nuclear research and materials production. In this capacity, by early 1950 the AEC oversaw a virtual nuclear empire that not only included old MED facilities at Oak Ridge, Hanford, and Los Alamos, but also encompassed offices in Washington, D.C. and facilities at Argonne National Laboratory (Chicago); Schenectady,

New York; Brookhaven National Laboratory, New York; and the University of California Radiation Laboratory at Berkeley, in addition to other small facilities around the country.²²

During this same period, international events conspired to make the AEC's defense mission even more critical, as international relations slid further into the deep freeze. Concerned that a devastated postwar Europe might drift into the Communist camp, the U.S. government introduced the "European Recovery Program," first espoused by George Marshall in June of 1947. The "Marshall Plan," as it was commonly known, was worked out between the U.S. and various European nations months before it passed Congress in April of 1948. Although offered to all European nations, Stalin saw to it that his side refused to participate. When middle-of-the-road Czechoslovakia expressed interest in the plan, the local Communists, aided by the Red Army, staged a coup in February 1948. This move also gave the Soviets direct access to the rich Joachimstahl uranium mines, desperately needed by Stalin's nuclear program.²³

Unwilling to cooperate with the Western allies in the postwar reorganization of Germany, Stalin initiated the Berlin Blockade, which began in the summer of 1948 and lasted almost a year. It was the first direct confrontation between the United States and the Soviet Union, and it led to the creation of the North Atlantic Treaty Organization (NATO) in 1949.²⁴ Other crises soon followed. In May of 1949, the Chinese Nationalists, still devastated from the Japanese invasion during World War II, collapsed before Mao's Communist insurgents. Even more ominous, on August 29, 1949, the Soviet Union detonated its first atomic bomb (a plutonium device), an achievement that Truman and most of the U.S. nuclear establishment thought would elude the Soviets for years to come.²⁵ At the end of 1949 and beginning of 1950, in the wake of the Soviet bomb, Truman and the AEC made plans for the development of the hydrogen bomb, the so-called "Super."²⁶ Almost simultaneously, Klaus Fuchs, a German émigré who had served in the British Mission to the Manhattan Project at the highest levels of plutonium bomb research, confessed to spying for the Soviets. This revelation in February 1950 sent shock waves through the nuclear community in both Britain and the United States, and seemed to reinforce the decision for both the Super and tighter security. Senator Joseph McCarthy began his accusations just days after news of Fuchs' confession, and four months later, on June 25, 1950, North Korea invaded South Korea.



Senator and Brigadier General in the U.S. Army Reserve Strom Thurmond, Representative Leroy Anderson and Captain Harry Peters, 1957. "Along the Iron Curtain, Looking into Communist East Germany from 11th Armored Cavalry Regiment Observation Post." Courtesy of the Special Collections, Clemson University Libraries, Clemson, South Carolina.

During the Korean War (1950-1953), the AEC's defense mission was paramount, as witnessed by the explosion of the first H-Bomb in November 1952, and the growth of the nation's nuclear arsenal from 300 to 1000 bombs. The military mission remained strong long after the war, with the official U.S. policy of "massive retaliation" announced by Secretary of State John Foster Dulles in January 1954.²⁷ The centerpiece of the nation's nuclear arsenal was the H-Bomb, a thermonuclear device that relied on a complex combination of fission and fusion, with fission required to heat and fuse atoms of hydrogen isotopes like tritium to release the high-energy neutrons required for the blast. During the 1950s, a number of thermonuclear devices were detonated, first by the United

States and quickly followed by the Soviet Union. These new bombs required increased supplies of plutonium as well as tritium, which had a half-life of 12 to 13 years. The push for the hydrogen bomb led to the expansion or establishment of new AEC facilities, beginning in 1950. Foremost among these new or improved facilities were the Los Alamos Scientific Laboratory, the Lawrence Livermore Laboratory in California, and the SRP in South Carolina.²⁸ The SRP was first conceived to produce tritium, but was designed to be versatile in its production capacity, accommodating the production of both tritium and plutonium, in addition to other nuclear materials.

The first U.S. thermonuclear device, Mike I, was detonated in November 1952, before the completion of SRP. However, for at least a decade after the first SRP reactor went critical in December 1953, the main, if not overwhelming, mission of the Plant was the production of plutonium and tritium, in the percentages required by annual AEC quotas. SRP played a crucial role in the production of nuclear materials for both fission and fusion bombs, first for Air Force bombers, and finally for the long-range missiles that became prevalent in the late 1950s and early 1960s. During the period when the Cold War was at its peak, between the Korean War (1950-1953) and the Cuban Missile Crisis (1962), SRP was a main contributor to the AEC's defense mission.



Mike Shot. Courtesy of the Los Alamos National Laboratory

Savannah River Plant as Part of the Big Picture

Cold War nuclear weapons production in the United States can be divided into four phases: (1) a research phase, (2) a growth and production phase, (3) a stabilization phase, and (4) a second growth and production phase. The first research phase lasted from the end of World War II until 1955. The second phase witnessed a period of growth and production that lasted from about 1955 through approximately 1967. It was in preparation for this production that the Savannah River Plant was constructed, and this period approximates the more productive

era of reactor operations at the site. The primary mission of the Savannah River Plant has been first to produce tritium, and second to produce plutonium and other special materials as directed by the Department of Energy and its precursor organizations.

Complex-wide, plutonium production reached its peak in the early 1960s. The third period was one of stability, during which the concentration of effort was on the improvement of performance and operations of the nuclear arsenal; this phase lasted from about 1967 until 1980. During this period, eight of the nine Hanford reactors were closed down, and the ninth reactor that remained in operation was used to produce fuel-grade plutonium. This left Savannah River as the primary source of weapons-grade plutonium during the period. The fourth phase was a second period of growth, which began in 1980 and saw the restart of L reactor at SRP and the return of Hanford's N reactor to weapons-grade plutonium production. In addition, SRP's C, K, and P reactors were used to produce super-grade plutonium that could be blended with excess fuel-grade plutonium that had been produced in the Hanford N reactor. This phase ended in 1988, when all plutonium production was halted.²⁹

The following context, which is specific to Savannah River Site, is based generally on this chronological framework. The plant's construction (1950-1956) is treated as a separate phase in the Site's history, followed by a stable period of production and performance improvement that lasts through 1979. Between 1980 and 1989, SRS experienced dramatic change. The decade began with expansion but this was soon sharply curtailed by shifts in the public's perception of nuclear technology and the abbreviation of the Site's defense mission with the fall of the Iron Curtain.

SAVANNAH RIVER PROJECT, 1950-1955

The Soviet Union detonated its first atomic bomb on August 29, 1949. Labeled "Little Joe" by American journalists, the bomb's unpublicized detonation was confirmed through the AEC's program of sampling rainwater. As a consequence, production needs were increased by the Joint Chiefs of Staff who established new minimum requirements for the atomic stockpile. Programs that had been stalled were now begun with vigor. To accommodate the perceived production needs, new "production piles" were required and the Joint Committee on Atomic Energy (JCAE) decided to build new reactors rather than upgrade those at Hanford.

Enlarging the stockpile was the first response to the Soviet bomb. The second was the decision to produce a hydrogen bomb, a weapon many times more powerful than the uranium and plutonium devices dropped on Japan at the end of World War II. On January 31, 1950, Truman signed a presidential directive that directed the AEC to continue work on all forms of nuclear activity, including the development of the thermonuclear bomb, stating, "We have no other course."³⁰ A program jointly recommended by the AEC and the Department of Defense to produce materials for thermonuclear weapons in large quantities received presidential approval in June. The AEC had already estimated the construction costs for a new production center at approximately \$250,000,000 and Sumner T. Pike, Acting Head of the AEC, immediately began negotiations with Crawford H. Greenewalt, president of E. I. Du Pont de Nemours & Co.³¹ Truman requested funds from Congress for the construction of two

heavy water reactors for the production of thermonuclear weapons on July 7 and shortly after the AEC drafted a letter contract framed in anticipation of Du Pont's acceptance of the project.³²

Du Pont Signs On

With the passage of the appropriations bill in early 1950, the AEC opened negotiations with Du Pont to build and operate the new plant. Du Pont had built the X-10 reactor and semi-works for the separation of plutonium from irradiated fuel slug facility at Oak Ridge and had built and operated Hanford during World War II through 1946. Both ventures left an indelible print on the corporation headquartered in Wilmington, Delaware, and the success of both Du Pont efforts had left an equally indelible print in the minds of the MED's Leslie Groves and the AEC. In the field of atomic energy industry, they were seasoned players with a pennant under their belts. Crawford Greenewalt and his staff had participated in a period of intense creativity in which the labors of atomic scientists in their laboratories were duplicated on the production line under wartime conditions. Between 1942 and 1946, Du Pont's engineers and scientists had become experts within the atomic energy field. No other American firm could match Du Pont's expertise in the design and construction of production reactors and chemical processing facilities.³³

AEC representatives visited Greenewalt formally in May of 1950 to apprise him of the proposed project and on June 8th the Wilmington firm was asked to complete the following: finish the site survey; design, construct, and operate a new reactor installation; and act in a review capacity for the technical aspects of the reactors and the processes for the production of heavy water.³⁴ The Commission also asked Du Pont to find a location that would not warrant the construction and management of a "company" town, a significant departure from previous military atomic energy plants established by the government.

Du Pont replied that it would consider the project if it had full responsibility for reactor design, construction, and initial operation. The "flexible" reactor design specified by the Commission called for a heavy water moderated and cooled reactor and Du Pont wanted to delay commitment to the project until they were able to review initial plans, particularly for heavy water production, and get a sense of proposed schedule. Greenewalt added a final proviso - that Truman himself request Du Pont's involvement in the project because of its urgency and its importance to the nation's security - which was done in a letter dated July 25, 1950.³⁵ Greenewalt's request was aimed at squelching any associations with the "merchants of death" label that lawyer Alger Hiss had leveled at the corporation in the 1934 U.S. Senate investigation of the munitions industry. Truman's letter, briefly written and to the point, would become an industrial icon for Du Pont. On July 26, Du Pont's Executive Committee adopted a resolution to undertake the project. The internal resolution also established the Atomic Energy Division (AED) within Du Pont's Explosives Department. The AED would be responsible for the new project.³⁶

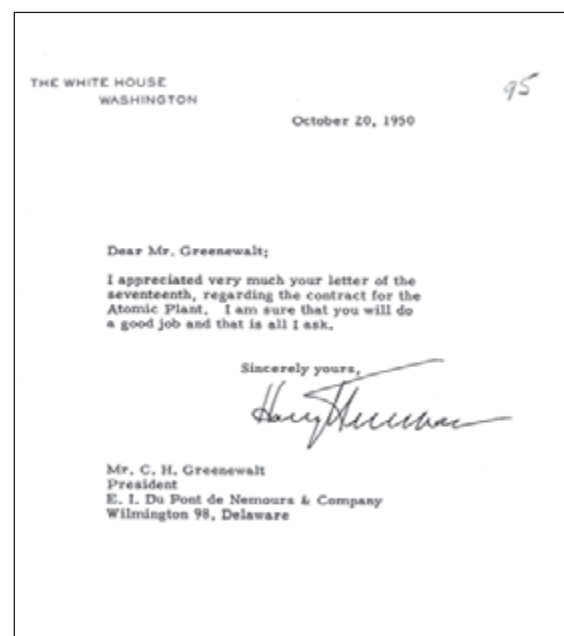

A letter contract, backdated to August 1, 1950, was signed between Du Pont and the AEC.³⁷ The letter, which would be superseded by a formal contract three years later, specified that there would be no “facility village” associated with the project and that Du Pont would not be held liable for any lawsuits that might result.³⁸ On October 18, Greenewalt wrote the company’s stockholders that Du Pont would assume responsibility for the construction and operation of the new facility. As at Hanford, the government would pay all costs and receive any patents that might develop out of the work; Du Pont would get an annual fee of just one dollar.³⁹ Some of the contractual clauses that were first written into the Hanford contract and were duplicated in the SRP contract would become standard in operating contracts undertaken in the modern nuclear industry.⁴⁰

At the time of the letter agreement, the AEC wanted Du Pont to build a tritium plant with two reactors, each to operate at an energy level of around 300 megawatts (MW). The AEC had selected the reactor type advanced by Argonne National Laboratory that was cooled and moderated with heavy water and Du Pont after review accepted the design. By 1950, heavy water reactors were considered more versatile than the graphite reactors Du Pont had built at Hanford and had better neutron economy.⁴¹ As early as August of 1950, Du Pont’s Atomic Energy Division had made preliminary improvements to the basic heavy water design proposed by Argonne and was on a pathway to construction.⁴²

Site Selection

The proposed site, referred to as “Plant 124,” was selected after a six-month investigation launched by Du Pont’s Engineering Department and aided by the U.S. Army Corps of Engineers (COE). Truman had advised AEC’s Gordon Dean not to brook any political pressure in the decision-making process and the selection process began on June 19, 1950.⁴³

The AEC had first contacted the COE and asked them to prepare a list of sites including government-owned lands that might be suitable. This preliminary data was reviewed in the Cincinnati Corps Office of the Great Lakes Division but was found lacking in definition. The following methodology was agreed upon: all rivers with a recorded minimum flow of 200 cubic feet per second (c.f.s.) were marked on sectional maps prepared by the Corps and locations within 20 miles to a river were considered. Bands were drawn along selected rivers and potential sites were located within these bands. The preferred site would also be located in the “The First Defense Zone” for strategic reasons imposed by the Department of Defense. This zone encompassed area that stretched from Texas to Virginia and north to Illinois. Embracing the central portion of the Southeast, it included 84 candidate sites. A second band of area that stretched from Arizona to New Hampshire was considered the “Second Defense Zone.” The latter had six candidate sites. C. H. Topping, Principal Architect and Civil Engineer within Du Pont’s Design Division, further described the selection process that was guided by “basic site requirements” that were jointly arrived at by Du Pont and the AEC. The requirements were: a one-square mile manufacturing area; a 5.6-mile buffer zone enclosing the manufacturing area; a 10-mile distance to neighboring communities of 500 individuals and a 20-mile distance from communities with 10,000 individuals; presence of supporting populations to absorb the incoming workforce; ample water and power supplies; accessibility by rail and highways; favorable meteorology and geology; and positive conditions for construction and operating costs.⁴⁴

Sixty-five sites were eliminated when progress in reactor design studies established that the minimum acceptable water supply was 400 c.f.s. By August 2, the list was pared down to seven sites. Members of the AEC, Army Corps of Engineers staff, and the Du Pont team, between August 6 and 17, chose these as candidates for a field inspection. Three local sites made it to this shortlist: two in South Carolina and one in Georgia. The site in Georgia was eliminated when it was learned that the Clark Hill reservoir would put a portion of the desired site under water and a site in northwestern South Carolina was considered too isolated. Site #5 in Aiken and Barnwell counties stayed in the running.

Changing water requirements also led to searches in colder climate areas both within and outside of the Second Defense Zone. These sites were put into the selection mix and similarly eliminated as the selection criteria were applied. In mid August, the requirement for the minimum water supply was increased to 600 c.f.s.⁴⁵ The Special Committee of the National Security Council on Atomic Energy had called for the construction of three additional reactors.⁴⁶

A final evaluation of sites using the original and expanded criteria focused on four locations. These were Site #125, which was located along the Texas and Oklahoma border on the Red River; Site #59 which was located on the border of Illinois and Indiana on the Wabash River; Site #205 which was located on the shores of Lake Superior in Wisconsin; and Site #5 located in Aiken, Barnwell and Allendale counties on the Savannah River in South Carolina. Essentially, three factors were compared. The first was the availability of large quantities of reasonably pure water for process capability, the second was the presence of towns of sufficient population that could absorb the proposed labor force but were at a sufficient distance to minimize any impacts, and third, the presence of sufficient land that was suitable to the construction of production areas. During the week of August 24th, these sites were field checked by the AEC's Site Review Committee composed of five experts drawn from American engineering firms such as Black and Veatch, Sverdrup, etc., that were authorities on site selection.

Site #5, a rural site along the Savannah River in South Carolina, was recommended to the Site Review Committee on November 13, 1950 as the final selection. In the words of Du Pont Engineer, C. H. Topping, it "more nearly meets the requirements than do the others."⁴⁷ The Site Review Committee concurred with the recommendation and Site #5 was selected. The AEC formally confirmed the decision on November 28 and the public was notified by an AEC press release on the same day. AEC's Curtis A. Nelson was named as the plant first local manager in August. Nelson, a Nebraska born civil engineer and colonel in the Manhattan Project, was familiar with heavy water technology through his work as a liaison with Canada's Chalk River Plant. He also brought strong construction experience to the new project from his years in the Civilian Conservation Corps and as engineer in the Corps of Engineers where he had supervised the construction of the Joliet Illinois Ordnance Plants.⁴⁸ He was charged, along with Bob Mason, Du Pont's Field Manager for Construction, with moving the project off the Du Pont Company's and their subcontractor's drawing boards and placing nine industrial plants into the rural South Carolina landscape. Mason, a Hanford veteran, was assigned to the project on September 25.

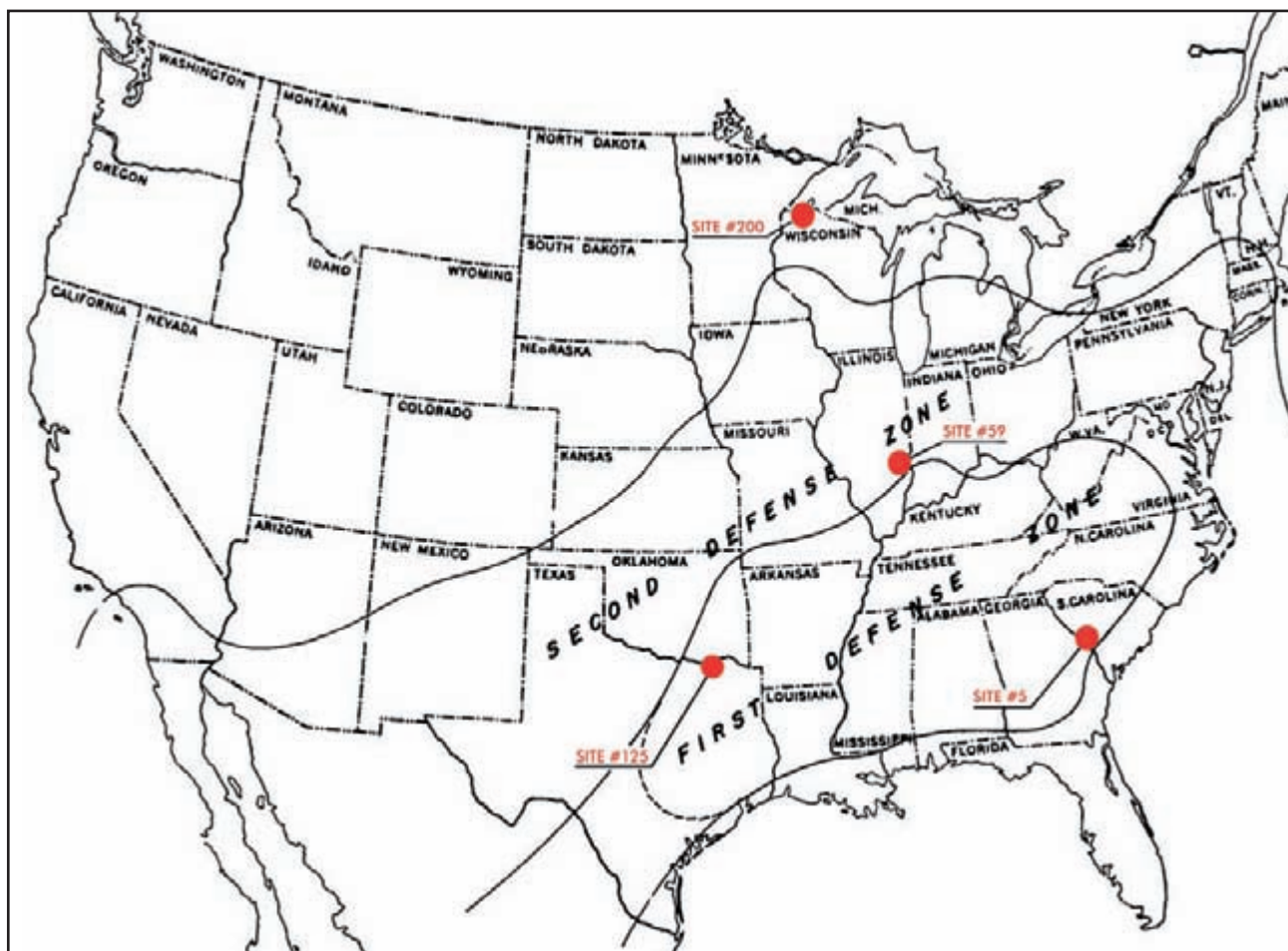

Site Selection Map Showing Military Defense Zones and the Location of Candidate Sites. Site No. 5 is the future Savannah River Plant.

Announcement

The swiftness and military execution of the site selection announcement attests to the months of planning involved in its preparation. At 11 o'clock on Tuesday morning, November 28, 1950, the announcement was made simultaneously at press conferences held in Atlanta and Augusta in Georgia; at Columbia, Charleston, and Barnwell, in South Carolina; and to mayors, presidents of chambers of commerce, state, city, and county officials. During the day, teams representing both AEC and Du Pont called on city, county, and state officials in Atlanta, Columbia, Augusta, Aiken, Barnwell, Ellenton, Jackson, Dunbarton, Snelling, Williston, White Pond, Windsor, and Blackville. Later in the day further details were released concerning the project by the AEC in Washington, D.C. Teams gathered that evening in the office of the Du Pont Field Project Manager at the Richmond Hotel to compare notes.⁴⁹

AEC Field Manager Curtis Nelson and Du Pont's Chief Engineer formally delivered the news to Governor Strom Thurmond and Governor-elect James F. Byrnes in Charleston, South Carolina, where they were attending the Southern Governors Conference. Governor Thurmond invited Georgia's Governor Herman Talmadge to join

in the press conference prepared for the journalists covering the conference. The timing of the announcement for what could only be forecasted as a regional economic success story was excellent for both Thurmond and Talmadge. Byrnes was well versed in atomic energy development for military purposes. He had acted as Franklin Roosevelt's "Assistant President," running the country while FDR fought the war and he was Truman's Secretary of State.⁵⁰ All three men were major figures in national and Southern politics and it is unlikely they watched the site selection process unfold without knowledge or interest.

The public announcement of the project signaled a new era in which the American public's right to know was at least partially fulfilled. Previous military atomic energy undertakings had been done in total secrecy as part of a wartime defensive effort. The Savannah River Project was complex and atypical as it was to be constructed during peacetime, its mission still required secrecy, and a government town was not to be constructed.

The latter meant that the surrounding communities, which were fairly settled, were to absorb the new workforce estimated in the thousands and to create the infrastructure and services needed for this population increase. Public disclosure was warranted and unavoidable. A straightforward approach was chosen in which public outreach and partnership initiatives were advocated. Public meetings, lectures, project managers working with community development and business leaders, and the airing of a movie called *The Du Pont Story* in Augusta for business leaders and new employees were just some parts of the AEC and Du Pont's well-orchestrated strategy for strong and positive public relations.

Site Description

With the site survey behind them, Du Pont moved forward with site definition and acquisition strategies. When acquired, the site would contain about 200,646 acres or 310 square miles within Aiken, Barnwell, and Allendale counties situated within two sub-divisions of the Atlantic Coastal plain: the Aiken Plateau and the Alluvial terraces that lie along the river. Eighty percent of the site was situated within the Aiken Plateau, where elevations ranged between 300 and 385 feet. The terraces are composed of three tiers of varying widths banding the river. From north to south, six streams dissected the tract: Upper Three Runs Creek, Four Mile Creek, Pen Creek, Steel Creek, Hattie Creek, and Lower Three Runs Creek. Five streams empty into the river in a southwesterly direction, the sixth, Lower Three Runs, flows to the southeast and drains the eastern portion of the proposed site. Although irregular in shape, the site measured roughly 22 miles in width and 22 miles in length.

The proposed site was rural but not isolated. The nearest large urban centers in Georgia were Augusta (20 miles northwest), Atlanta (155 miles west and north), Savannah (85 miles to the southeast) and in South Carolina, Columbia (65 miles northeast). In addition, data was gathered on towns with populations of over 1,000 individuals



Front page of *The Augusta Chronicle*, November 29, 1950, reported on the announcement from several angles reflecting the many meanings the new plant would have for the country, the CRSA, and for those displaced by the proposed land acquisition.



Meeting at Ellenton Auditorium, December 6, 1950. The U.S. Corps of Engineers real estate officers responsible for the land acquisition called a public meeting in Ellenton. A representative from each family was asked to attend the question and answer session. Reportedly, over 500 individuals attended what appears to have been a segregated meeting with attendees, both black and white, spilling out of the main hall into the building entries and lobby. Courtesy of SRS Archives, negative 1221-1.

within a 50-mile radius to the site. The project area contained seven communities: Ellenton and Hawthorne in Aiken County, and Dunbarton, Meyers Mill, Robbins, Leigh, and Hattieville in Barnwell County. Ellenton, a post-Civil War railroad community and local trading center, was the largest with a population of 600. Dunbarton, also a railroad town, had a population of 231 individuals. The remaining communities were smaller. Meyers Mill possessed some stores and a cotton gin while Leigh was synonymous with a box and crate manufactory, the Leigh Banana Case Company, that operated at that site between 1904 and 1954, employing about 300 people in 1950.⁵¹

Camp Gordon, Oliver General Hospital and its annex, Daniel Field, and the Augusta Arsenal were military installations less than 26 miles from the proposed site and six airports, five municipal fields on which there was a recapture clause in case of war and one USAF inactive airfield, that were within 40 miles.⁵² The existing road system was composed of state highways that intersected with U.S. highways and in addition, there was a well-defined network of unpaved “farm to market” dirt roads. Rail service was already in place. The Charleston and Western Carolina (CWC) Railroad paralleled the river, providing service from Savannah to Augusta and the Atlantic Coast Line Railroad ran from Barnwell to Robbins where it joined the CWC line. The CWC ran through Ellenton and Dunbarton and the smaller communities were railroad stops on the line.

Three companies provided power to area residents and businesses: the South Carolina Electric and Gas Company, the Aiken Electric Cooperative, and the Salkahatchie Electric Cooperative. Two phone companies, Southern Bell and Cassels Telephone Company, were communications providers as were telegraph offices in Ellenton and Dunbarton. U.S. post offices were located in Meyers Mill, Ellenton, and Dunbarton.⁵³

The acquisition process was handled over an 18-month period by the South Atlantic Real Estate Division of the U.S. Army Corps of Engineers on behalf of the AEC. The process formally began the day after the announcement so that the government would have the necessary lands either by declaration of taking or through actual purchase by June 30, 1952. The acquisition process was staged to accommodate construction requirements. Priority zones were established, rights of entry obtained, and property transfers swiftly occurred. Ultimately, 123,100 acres situated in Barnwell County, 73,462 acres in Aiken County, and 4,084 acres in Allendale County were acquired. Boundary realignments occurred as the acquisition process progressed, eliminating two of the four communities (Jackson and Snelling) that were originally within the project area and adding on a 4,453 acre corridor of land on both sides of Lower Three Runs Creek in Barnwell and Allendale counties.

Six thousand individuals were evacuated from their homes and homesteads. Some displaced owners moved their homes, joined neighboring communities, and worked at the plant. Business owners relocated and new businesses were spawned by the influx of plant employees, particularly during construction. Others sold their properties and left the area viewing the change as an opportunity. While a sense of patriotism motivated most of the project area residents, it was difficult for all involved as government appraisals were guaranteed to fall short when values were attached to land that had generations of farming and family life invested in its soil.



Some residents preferred to move their homes to locations outside the new federal site. Du Pont designated a House Moving Coordinator to handle the moves. All land was acquired by June 30, 1952. Courtesy, SRS Archives.

Site Layout

SRP was originally organized into nine manufacturing areas, a central administration area, and two “service”-building building areas known as the Temporary Construction Area (TC Area) and Central Shops. Between building areas, buffer areas were forested, masking the earlier landscape and providing a sense of distance and isolation. The areas were linked by a well-designed transportation system that included 210 miles of surfaced highways, a cloverleaf that was the first constructed in the state, and 58 miles of railroad track. Previous road names were erased and letter designations, such as Road A, Road B, etc., were assigned.

Each area was given a number and a unique letter designation (Table 1). Function was reflected in the area numbers; letters identified site geography. This code-like system, used first at Hanford for the identification of building areas and their associated facilities, and the road lettering system heightened the anonymous and utilitarian character that evolved at the site.

the mouth of Upper Three Runs Creek and a second two miles upstream from the first, supplied water to the 100 areas, primarily for cooling the heavy water coolant.

The 200 Areas, 200-F and 200-H, were also centrally located within the site's core area, approximately 2.5 miles from the closest reactor area and about 6 miles from the project area perimeter. The canyon buildings, massive concrete buildings, would dominate each separations area. F area contained four process buildings originally and was built to be self-sufficient. H Area did not contain the same process buildings but space was allotted for future expansion. Water to both 200 areas was supplied from deep wells.

The 400-D Area, located near the site's southwest perimeter approximately one mile from the river, housed heavy water production units and support buildings. Resembling an oil refinery, the 400 Area was characterized by three steel tall tower units, a flare tower, a finishing facility and other support buildings including a powerhouse. After SRP was closed to the public, this area was viewable from outside the site boundaries and the GS towers and flare tower was the visual image most area residents connected with SRP. A third river pump house supplied water to 400 Area.

The 300-M Area was situated near the northwest perimeter of the project area where it was laid out in a rectangle that adjoins the 700 Area. It contained testing and fabrication facilities for reactor fuel and targets. Two buildings, 305-M (now 305-A) and 777-M (now 777-10A), contained test reactors that were used to test the components manufactured in the 300 Area and to aid development and testing for SRP reactor design.

The 700-A Area was SRP's administrative and "service" center. It contained the main administration building noted in the excerpt above, the medical facility, communications facilities, patrol headquarters as well as a variety of maintenance and storage buildings. A Area also contained the Main Technical Laboratory, now Savannah River National Laboratory, in which plant processes were researched, designed, and tested, and other research facilities.

Finally, two pilot plant facilities, CMX and TNX, were located near the 400 Area. The former was designed to run corrosion tests on heat exchanger equipment installed in the reactors and to investigate what types of water treatment processes were needed for plant operations. A small pump house accompanied it. The latter was a pilot plant for processes completed in the 200 area canyons.

Nine coal-burning powerhouses located in the building areas supplied steam to the process areas and the overall site. The large pipes that carried the steam are above ground, arching over roadways where necessary and paralleling the road system. Outside the manufacturing and service building areas, general facilities needed for either process support or general site support included three-river water pump houses, a pilot plant, railroad classification yard, and burial ground for solid wastes.

The first generation of buildings at SRP was simply designed using a functional ethic. The AEC's specification that the project's buildings be spartan in their design was a done deal given the climate of American post-war industrial architecture. The choice of building materials, reinforced concrete and transite paneling, were mandated by the

building code. Articulated in reinforced concrete or steel frame with transite panels, the majority were beige or gray boxes built for maximum flexibility and for government service. Their uniformity in color, their number and size, and their geometric forms create a harmonious grouping of buildings within an ordered industrial landscape where form reverberates function. This functional perspective is further emphasized by the placing of the Site utilities aboveground so that massive pipes parallel roads or arch over them. Economically motivated, this design feature has strong visual impact.

Subcontractors

It was recognized from the start that Du Pont Engineering Department would need supporting organizations to complete the project given its size and schedule. Temporary use was made of the Bush House located on Highway 19 as the Field Construction Office and a tenant farmer's dwelling was adapted for use as the Field Cost Office. The need for immediate construction buildings while Du Pont was organizing called for the hiring of a local architectural and engineering firm, Patchen and Zimmerman of Columbia, SC, to get things off the ground.⁵⁵ This firm's design work at the TC Area with its two massive cartwheel buildings and the adjacent cloverleaf created one of the most visually appealing layouts on site.

Engineering and design assistance to Du Pont was provided by the following subcontractors: American Machine and Foundry Company, Blaw-Knox, the Lummus Company, Gibbs & Hill, Inc, and Voorhees, Walker, Foley & Smith. Each of these firms had demonstrated experience in their respective areas and each made significant contributions to the equipment and SRP building stock.



Architectural Rendering of the Main Administrative Area (700-A) and the Fuel and Target Fabrication Area by Architects Voorhees, Walker, Foley & Smith, ca. 1951

Table 2. Subcontractors for Du Pont Project 8980.

American Machine and Foundry (AM&F) - This firm was charged with the design and fabrication of special mechanical equipment for use in the 100, 200, 300, and 400 area process facilities. AM&F described their firm as manufacturers of machines for industry. In 1950 they were considered the world's largest manufacturer of cigarette and cigar making equipment.⁵⁶

The Lummus Company - This firm was requested to design and partially procure six "GS" units (towers 116' in height) including the DW and finishing plants for the 400 area heavy water production facilities. This firm brought strong petroleum, petrochemical, and chemical experience to the project. Self described as a network of men, minds, and machines that were dedicated to transforming ideas and capital into profit earning processes and equipment, the Lummus Company, international in scope and headquartered in New York, were expert in the design of distillation processes.⁵⁷ The 400-area design benefited from an agreement between the Girdler Corporation, which had designed the Dana Plant, and the Lummus Company for the exchange of technological information gained from the Dana Plant that could be applied at SRP.⁵⁸

Blaw-Knox Company - Design of process buildings and equipment required in 200 area facilities, general area facilities (600 area) related to 200 area processes.

Gibbs & Hill, Inc. - Design of steam, water, and electrical facilities for process areas and overall plant. This engineering firm based in New York was subsumed by Dravo Corp of Pittsburgh in 1965 then later sold to Hill International, a New Jersey based firm.

Voorhees, Walker, Foley & Smith - This New York architectural/engineering firm was responsible for the design for all "service" buildings including laboratories and general facilities including roads, walks, fences, and parking areas; the manufacturing buildings in the 300 area; laboratories; some design work for 200 areas and overall site clearance at SRP. It was also responsible for Du Pont's Experimental Station in Wilmington, the MED laboratories at Columbia University and Argonne National Laboratory.⁵⁹

New York Shipbuilding - This firm was responsible for fabricating the five reactor vessels that were transported by barge to the South Carolina site. Known as the NYX Program, this effort produced the cover plate of the reactor vessels known as the "plenum" (a laminated steel plate 19 feet in diameter, four feet thick, weighing about 100 tons, and drilled with 500-4-inch tubes), the reactor vessels, and the primary piping.⁶⁰ Organized in 1899, New York Shipbuilding was located on the banks of the Delaware River in South Camden, New Jersey. The firm brought its experience in the fabrication of heavy industrial equipment and machinery to the task. A company history notes that the firm had taken on projects as "a public service where the facilities of the Yard provided the only available means for constructing unusual items. Its location on tidal waters, with weight handling equipment up to 300 tons, makes it possible to load assemblies which may be beyond the size or weight limitations for shipment by rail."⁶¹ These qualities were probably well known to Du Pont who also had a plant in the Camden area.

Unfolding Scope of Work and Flexible Design

By Hanford standards, the 38 months from start of construction to operation for C reactor at Savannah River was quite slow. However, by the standards of a later generation of nuclear engineers, such a pace would appear incredibly rapid. The placing of R reactor in operation in December 1953, when the conceptual design had only been sketched out in December 1950, seemed to later nuclear specialists a remarkable achievement in engineering and management.⁶²

The scale, shape, and funding of the Savannah River Project and the mix of plutonium, tritium, and other radioisotopes to be produced in its reactors was determined by the AEC. The schedule was set by world events. Du Pont’s design team, in association with their primary subcontractors, was responsible for translating the larger conceptual design outline by the AEC into reality within an atmosphere of “urgency and commitment.”⁶³ Du Pont designers accomplished their goals using a “flexible design” approach. This approach operated at two levels: the first entailed postponing design decisions until the best design could be determined by research or through consultation, and the second was to build in the potential for future design options should AEC policy change.

In the first scenario, Du Pont designers based some design decisions on their experience from previous atomic energy plant construction projects and from scientific research completed at the AEC’s national laboratories. This allowed them to move forward with production in some areas while alternative design choices were researched for others. In the second scenario, postponement of design was necessary as part of the current and future client-contractor relationship. AEC directives, based on Department of Defense guidance on what product or product mix was needed for its weapons program, directly translated into design decisions. Du Pont recognized this as an integral feature of their contract and responded with aplomb to an evolving scope of work. Their ability to do so was characteristic of the firm’s management that had an internal set of departmental checks and balances and well-honed procurement strategies.⁶⁴

SRP Operations, 1955 - 1989

As an integral part of the nuclear weapons production complex, SRP’s primary mission has been first to produce tritium, and second to produce plutonium and other special materials as directed by DOE and its precursor organizations.⁶⁵ Its role was not one that can

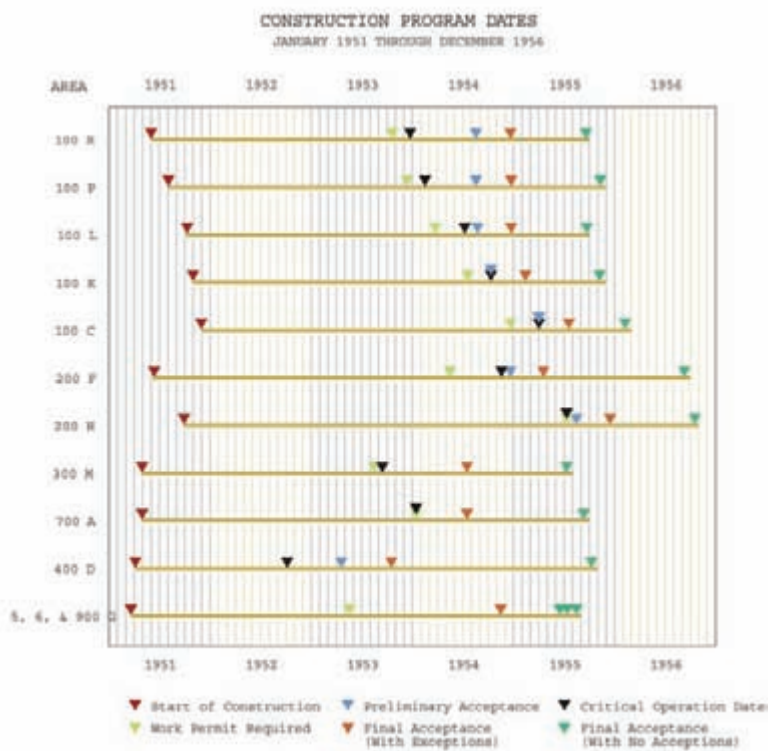

Bar Graph showing the construction schedule and the milestones reached. Source: Engineering Department, E. I. Du Pont de Nemours & Co., Savannah River Plant Construction History, Volume I, DPES 1403, 1957.

be described as one step along a linear process, but rather as one of the hubs of material movement through the complex. Table 3 shows how the site was integrated into the overall nuclear weapons complex and the direction of material flow that established the relationship.

| <u>Other Sites Within Complex</u> | <u>Direction of material flow</u> | <u>SRP Area</u> | <u>Type of Material</u> |
|---|-----------------------------------|-----------------|--|
| FMPC and Weldon | To | 300 Area | Raw Materials: natural and low enriched uranium for fuel and target manufacture |
| Oak Ridge Site Y-12 Plant | To | 300 Area | Isotope enrichment: highly enriched uranium for fuel and target manufacture |
| Oak Ridge Site Y-12 Plant | To | 300 Area | Isotope enrichment: Lithium for target manufacture |
| Oak Ridge Site Y-12 Plant | From | 400 Area | Isotope enrichment: Heavy Water for deuterium production and deuterium gas |
| Dana Plant | To | 100 Area | Isotope enrichment: Heavy Water for moderator and coolant |
| FMPC and Reactive Metals, Inc. | From | 300 Area | Fuel and Target Fabrication: depleted uranium for fuel |
| Weldon Spring Plant, FMPC, Oak Ridge Site K-25 Plant, and Paducah Gaseous Diffusion Plant | From | 200 Areas | Separations (for raw materials recycle): low enriched uranium for recycle |
| Oak Ridge Site Y-12 Plant | From | 200 Areas | Separations (for raw materials recycle): highly enriched uranium for recycle |
| Rocky Flats | From | 200 Areas | Separations: plutonium metal buttons for pit production |
| Mound Plant | To | 200 H Area | Separations/component manufacture: recovered tritium for purification and reuse |
| Pantex Plant and Iowa Army Ammunition Plant | From | 200 H Area | Separations/component manufacture: filled tritium reservoirs ready for assembly |

Source: USDOE Office of Environmental Management, *Linking Legacies: Connecting the Cold War Nuclear Weapons Production Processes to their Environmental Consequences* (Washington, DC: USDOE Office of Strategic Planning and Analysis, 1997), 18-19, 154-155.

Heavy Water Production and Rework

The Heavy Water plant at SRP (the D Area) used the Girdler Sulfide (GS) process of hydrogen sulfide-water exchange. This portion of the plant, completed in 1952, included 144 process towers ranging from 6.5 to 12

feet in diameter, each 120 feet tall.⁶⁶ Between 1952 and 1957, the D Area plant and the heavy water plant at Dana, Indiana, supplied most of the heavy water for the nuclear weapons production complex. A sufficient stockpile of heavy water had been accumulated by 1957 to allow the closure of Dana and of two-thirds of the Savannah River units. The remaining units continued to operate until 1982, primarily to reconcentrate heavy water that became diluted during reactor operations. During its 30 years of operation, D Area produced over 6,000 tons of heavy water.⁶⁷

In the spring of 1953 a small plant was constructed in D Area to produce deuterium gas from heavy water by electrolysis. Some of this deuterium was used at Savannah River in the Tritium facility (tritium reservoirs were actually filled with a mixture of tritium and deuterium), and some was sent to the Oak Ridge Site to be converted to the lithium deuteride used in the secondary assemblies of thermonuclear weapons. A second, larger deuterium plant was constructed in D Area in 1954.⁶⁸

Fuel and Target Fabrication

The manufacture of early reactor fuel elements, or slugs, was fairly straightforward. Although there had been problems in the early fabrication process at Hanford, the lessons learned there allowed SRP production in the M Area to proceed with relatively few problems. The slugs were solid natural uranium rods about one inch in diameter and eight inches long, clad in aluminum. The uranium rods were fabricated by the FMPC and shipped to Savannah River. The metallurgical structure of the uranium rods was adjusted (first at Savannah River, later at FMPC prior to shipment); the slugs were then sealed in aluminum.

Lithium target slugs were also needed for the production of tritium, and for use as control rods in the reactors. Lithium was sent from the Oak Ridge Site to Savannah River Building 320-M, where it was alloyed with aluminum, cast into billets, extruded to the proper diameter, cut to the required length, and canned in aluminum. The lithium-aluminum slugs were also encased in aluminum sheaths, called raincoats. At Savannah River, tritium was initially produced as a reactor byproduct in the lithium-aluminum control rods. As AEC requirements for tritium increased, reactor elements specifically designed for tritium production were needed. Driver, or fuel, elements of highly enriched uranium were used to provide the neutrons for irradiating the lithium-aluminum target elements. Enriched uranium drivers were extruded in 320-M until 1957, after which they were produced in the newly constructed 321-M, built specifically for this process.⁶⁹

The M Area at Savannah River continued to produce most of its own fuel and target assemblies until the end of the Cold War. Revisions and upgrades were made to the facilities, as needed, one of the most important being the change from solid slugs to tubular elements. The production of solid slugs ended late in 1957. Production in the M Area increased and decreased with the needs of the reactors. The last large increase was in 1983, when the operations in 321-M went to 24 hours a day. Operations fell off as the reactors closed, and for the most part have ceased altogether since 1989, when the last reactor was taken off line.⁷⁰ This report provides a more detailed account of SRP's 300/M Area's genesis and operations history in the following chapters.

Reactor Operations

There were five production reactors operating at the Savannah River Plant during the Cold War, identified as C, K, L, P, and R reactors. The first SRP reactor to go online was the R reactor, which was tested for integrity and operability during the fall of 1953 and brought to criticality in December. The first few months of operation were problematic because instruments triggered frequent automatic power reductions and “scrams,” or unscheduled emergency shutdowns. Improvements to the instrumentation and signal systems mitigated these problems, and the number of scrams, one a day in February 1954, fell to an average of one in three days in May. P reactor was the second to go critical, the event occurring on February 20, 1954. The first irradiated fuel was discharged from R reactor the following June, and all five reactors were operating by the end of March 1955.⁷¹

Changes were quickly made to both how the reactors operated and to the reactors themselves. Although Savannah River was originally intended as a tritium production site, the lithium-aluminum slugs from which tritium was produced were at first used only as control rods, and tritium was produced as essentially a byproduct of plutonium production. However, AEC requirements for tritium production had increased by 1955, and that year the reactors were loaded in configurations specifically meant to produce tritium. As operators found they could increase the power levels at which the reactors operated, they began adding extra heat exchangers to eliminate the increased heat. C reactor had 12 heat exchangers, but the other four reactors only had six, a necessary shortcoming due to limited supplies of heavy water and vendor production capabilities during the construction period. The number of heat exchangers was increased to 12 on all reactors in 1956, and the original power output of 378 megawatts was increased to 2,250 megawatts.⁷² A megawatt, as used in reference to production reactors, is not a measure of electrical generation but of thermal output, a convenient measure of the operation of a reactor.

To further increase the capabilities of the cooling system, a large retention lake was created. Heavy water was used to remove heat from the reactors, and light water from the Savannah River was used to remove heat from the heavy water. The increase in the amount of heat being removed via the heavy water meant a concurrent increase needed to be made in the amount of heat being removed by the light water. Unlike the heavy water, the light water was returned to the river, so a means of dissipating its heat before returning the light water to the environment was necessary. The 2,600-acre P and R (PAR) Pond was constructed for this purpose, and was integrated into the cooling system in 1958. All the cooling water from R reactor then was routed to Par Pond, and a portion of P reactor water was sent out via Par Pond. The new reservoir not only served as a means of cooling water, it also created an additional source of cooling water for P and R reactors, which produced savings in pumping costs. Since they would then be drawing less water from the Savannah River, more would be available for the other three reactors. This and further improvements in the light water circulating system allowed C reactor to be brought to a power level of 2,575 megawatts in 1960, and to eventually reach its all-time peak of 2,915 in 1967.⁷³

Another major change in reactor operations came with the use of computers. Computers were first used to monitor the 3,600 reactor process sensors on an experimental basis in K reactor beginning in 1964. The experiment was successful, and the system was added to the three other then-operating reactors (R reactor had been placed on standby in 1964) by the end of 1966. In 1970, a closed loop control system began trial operation at K reactor.

Computers were used to assess information from the sensors, and to make adjustments to groups of control rods based on that information. Using computers to do this was another means of optimizing reactor performance. In the late 1970s, new computer systems were installed to provide safety functions and to monitor and add additional control over reactor operations.⁷⁴

By 1970, the heyday of reactor operations had passed. R reactor was shut down in 1964 due to a lack of demand for reactor-produced products, and L reactor was placed on standby status in 1968 for the same reason. C, K, and P reactors continued to produce tritium, plutonium, and other isotopic elements as directed by the AEC in pursuit of both military and non-military programs.

Separations

Operations at the Savannah River Plant included two main types of separations: combined plutonium and uranium extraction, and tritium extraction. The former was conducted primarily in the canyons in F and H areas. The F Canyon went into operation in November 1954, and the H Canyon was online the following July. In these two buildings, the fuel elements that came from the reactors were dissolved in acid to separate the uranium and plutonium from waste fission products by chemical extraction in solution. Tritium separations took place in two much smaller areas. Slugs irradiated to produce tritium were initially sent to a building in the F Area, which started operating in October 1955, where the slugs were melted, instead of dissolved, to release the gaseous tritium. After melting, the tritium was purified by a process known as thermal diffusion. Tritium extraction was moved to its current location in H Area a few years later.⁷⁵

The two canyons were originally designed to operate using the Purex process by remote operation and maintenance—which meant that the process areas were not designed to be entered by personnel on a routine basis. During the first year of operation, the F Canyon attained its designed throughput level of three metric tons of uranium per day. Modifications to the H Canyon by applying lessons from early operations in F Canyon allowed H Area operations to see a throughput of seven tons per day.⁷⁶

In early 1957, the F Area canyon was closed down so that substantially larger equipment could be installed to increase throughput, and so that a new facility to convert the plutonium to metal could be built on the canyon roof. This would more than double the capacity of the canyon. The modifications took two years to complete, and the F Canyon went back into operations in March 1959, with a capacity to process 14 tons of uranium each day.⁷⁷ As soon as F Area was back in operation, H Area was shut down for conversion to a modified Purex process designed to safely recover enriched uranium from target elements then beginning to be used in the SRP reactors, a change that took only three months. H Canyon was back in operation by June.⁷⁸ Many more minor modifications of the canyons followed over the years to allow products other than uranium and plutonium to be recovered, but the fundamental processes for extracting plutonium and uranium remained essentially the same throughout the Cold War.

The first tritium facility was located in Building 232-F. A 232 building was also constructed in the H Area, but it was not completed during the initial phase of construction. The H Area tritium building was outfitted for production in 1956, and by the end of the year two lines were operating. Tritium was originally shipped

elsewhere for placement in the reservoirs, but by 1957 this was completed in the Reservoir Handling Building. In August of the following year, tritium began being recycled in this facility as well. Tritium processing capacity in the H Area facilities was doubled in 1958, and the F area 232 facility was closed that autumn. A new facility, the Replacement Tritium Facility, went into operation in 1993, and it continues to perform the tritium mission today.⁷⁹

Waste Management

In general, the waste facilities at Savannah River were modeled on those at Hanford but modified somewhat since the radioactivity of the high-level wastes would be greater than those at Hanford. The original tanks each had a capacity of 750,000 gallons, were supported by internal columns, set on top of a steel pan to catch any leaks, and encased in concrete. Separate tanks were provided for high- and low-level wastes, and the high-level units were provided with cooling coils to remove heat generated during the decay of the wastes (cooling coils were added to all these tanks in 1955). Waste evaporation facilities were also provided as a means of reducing waste volume.⁸⁰

Eight such tanks were originally built in the F Area, and four in the H Area (with space for four additional tanks set aside), each buried under at least 9 feet of soil. Four more tanks were approved for H Area in 1954, due to expected increases in the throughput of H Canyon. These four tanks were larger, each having a capacity of 1.07 million gallons, but other details of design were essentially the same as that of the original 12 tanks. They were constructed in 1955 and 1956. By June 1955, the first high-level waste tank was already full, prompting efforts to reduce the volume of waste sent to storage.⁸¹

Four single-wall tanks for low-heat high-level wastes were constructed in the F Area in 1958, and four in the H Area in 1962. These tanks have caused numerous problems due to leakage through fine cracks caused by the reactions of the solutions stored there with the materials in the tank walls. However, only one of the original 12 tanks has leaked substantially. Four others have deposits on the outside of the tank walls that may indicate leakage, but no leaks have been found. An additional 27 tanks, each with a capacity of 1.3 million gallons, have been constructed since 1962. These are all similar in design to the initial tanks, except the catch pans extend the full height of the tanks, rather than only five feet, as with the initial design.⁸²

Two burial grounds serve as the disposal site for solid wastes. The original burial ground occupied about 76 acres and was used from 1953 until 1972. The second, larger burial ground has been used since 1972; it covers approximately 119 acres. Solid low-level waste from all plant areas were buried there, with special areas set aside for items with higher levels of radiation or with plutonium fission products. The TRU solid wastes were buried in designated sections of the burial ground early on but, by the early 1980s, they were being stored on concrete pads in containers that allowed for later retrieval.⁸³

Research, Development, and Testing

The scientists and researchers at the Savannah River Laboratory (SRL) were responsible for research and improvements in process design in support of SRP's operations. From the beginning, it was noted that neither

SAVANNAH RIVER'S TEST REACTORS

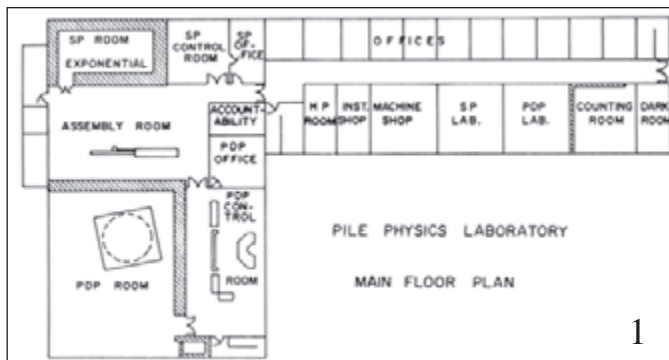

1

1. Pile Physics Laboratory floor plan. This facility housed three test reactors used by SRL researchers. The reactors were placed under the high-hat area of the building. Courtesy of SRS Archives, negative DPSTF-83. 2. Pressurized Subcritical Experiment (SE) test reactor in Pile Physics Laboratory that was used to measure nuclear parameters at high pressures and high temperatures. When built, it was the first of its kind. Courtesy of SRS Archives. The Standard Pile (SP) was designed and constructed by the General Electric Company and was similar to the Thermal Test Reactor at Knolls Atomic Power Laboratory. (Not shown). 3. Fuel elements were placed in the Process Development Pile (PDP), a zero-power test reactor used for physics research. Courtesy of SRS Archives, negatives DPSTF 1-2613, 1-2536. 4. PDP control room. Courtesy of SRS Archives, negative DPSPF-8929-13.

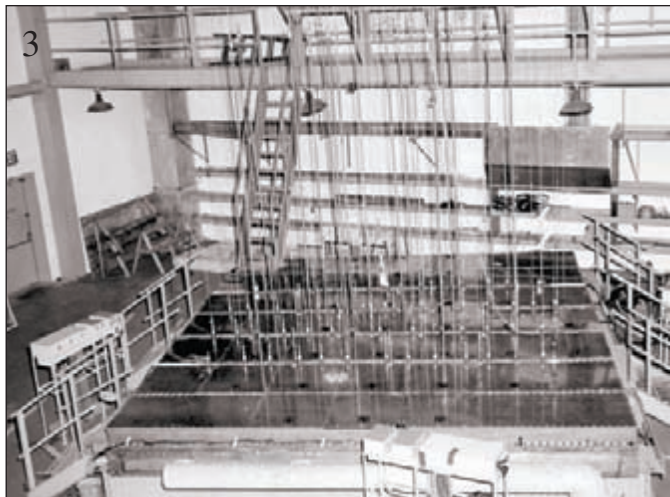

3

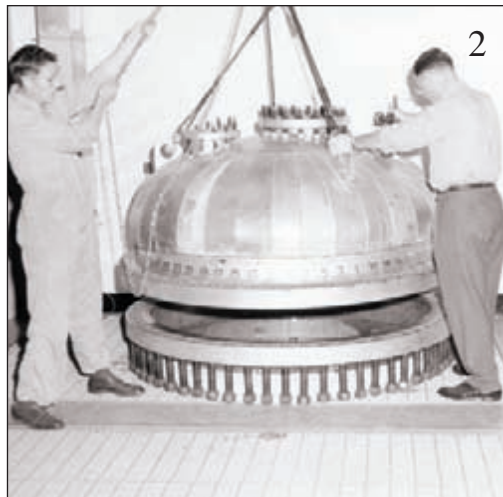

2



4

PEOPLE, RESEARCH AND DEVELOPMENT



5

5. Graphite Test Pile control room in 305-M. Courtesy of SRS Archives, negative 2023. 6. Face of Graphite Test Pile, Courtesy of SRS Archives, negative 38887-1. 7. Interior of Heavy Water Components Test Reactor. Courtesy of SRS Archives, negative DPSTF-6027. 8. Aerial of Heavy Water Components Test Reactor (HWCTR). This test reactor facility was decommissioned in 1997. Courtesy of SRS Archives, negative 7885-G.

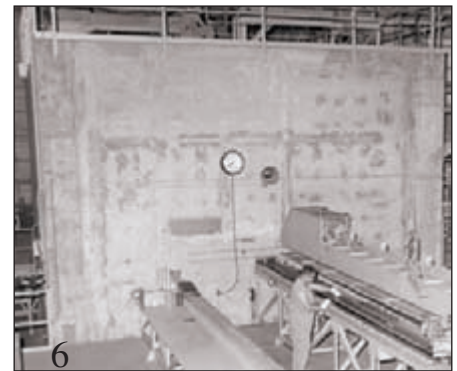

6



7



8

heavy-water moderated reactors, nor the Purex process, had ever been operated on an industrial scale.⁸⁴ Also, the versatility of the reactors called for the development of new fuel and target elements. The need to explore the safety and process issues involved called for the installation of laboratory facilities that were fully equipped to allow research and experimentation on a laboratory or micro scale of the processes that were writ large in the process buildings. Consequently, the general laboratory area that was established in A Area was fitted out with sand filter systems and waste treatment facilities. The main research facilities were: the main laboratory; 777-M (later 777-10A), an experimental physics laboratory; process pilot plant facilities CMX and TNX (also referred to as semiworks); 735-A, the Health Physics Laboratory; and 723-A, the Equipment Engineering laboratory.

SRL, the main laboratory, was the focus of separations technology studies, metallurgical research and development, heat transfer studies, and radiation monitoring. Its "High Level Caves" allowed chemical and metallurgical equipment studies on highly radioactive materials behind heavy shielding windows and the Isotopes Process Development Laboratory allowed radionuclides to be encapsulated for use as targets.⁸⁵ After 1983, the testing of new fuel and target elements was moved from CMX to SRL. The TNX Semiworks Facility, a pilot plant, was equipped with instrumentation and stainless steel equipment for "cold" processing for chemical engineering studies on a larger scale afforded by the main laboratory facilities.

777-M, later designated 777-10A, the Physics Laboratory, contained three test reactors: the Process Development Pile, the Standard Pile, and the Subcritical Experiment. These test reactors allowed scientists to provide experimental measurements needed to test reactor charge design. While computers would eliminate the need for these test reactors in the 1980s, they were integral to the safe and successful operation of SRP's five reactors, as reactor charges were first tried out in the laboratory environment prior to their use in reactor operation. The reactor designers who used the test reactors in 777-10A used slide rules, mathematical tables, and desk top calculators to make the calculations that would later be generated by computers.

In addition to the central mission of supporting plant operations, a second laboratory system was established at SRP devoted to environmental studies. Savannah River Ecology Laboratory (SREL) was first housed in the Forest Service area but was given a new building in 1977 in A Area where it is surrounded by a complement of environmental laboratory facilities that range from duck pens to greenhouses. SREL and a consortium of other research programs conducted by the Savannah River Forest Station (SRFS), Savannah River Archaeological Research Program (SRARP) and Du Pont conduct research on disparate ecological topics that range from reptile studies, aquatic insects, restoration of degraded habitats, reintroduction of endangered species, and investigations into the Site's cultural history. SRS was designated as the first National Environmental Research Park (NERP) in 1972 as a result of the National Environmental Policy Act (NEPA), the Energy Reorganization Act and the Non Nuclear Energy Research and Development Act. Under these acts, the Site area became an outdoor laboratory set aside for national environmental goals in ecological research, research into the effects of nuclear energy on the environment, and finally, the disposition of this area is reportable to the public.

DEVELOPMENT OF PEACEFUL USE OF ATOMIC ENERGY, AND ITS IMPACT ON SRP

The tug-of-war between military and non-military applications of atomic energy was present at the inception of the AEC. Senator Brien McMahon of Connecticut championed civilian control over atomic power, and his bill, which became the Atomic Energy Act of 1946, barely beat out others that championed direct Army control.⁸⁶ Congress passed the McMahon Bill in July, and Truman signed it into law the following month. According to this act, the AEC was to become effective December 31, 1946/January 1, 1947.

After advice or directives had filtered through the Commission, the Office of the General Manager carried out the directives, with work divided into various divisions, such as Production, Raw Materials, Military Application, Research, Engineering, Biology and Medicine, and Administrative Operations.⁸⁷ Even though the AEC's main mission was defense-related (peaceful use of the atom was not even a formal part of the Atomic Energy Act of 1946), civilian control meant that there was always a push at the AEC to justify atomic energy use for non-military purposes.

The early leadership of the AEC certainly demonstrated this interest in the non-defense mission. David Lilienthal, appointed as the first chairman of the AEC by Truman in October 1946, was himself a strong proponent of the peaceful use of atomic energy, taking his case to the public in a number of articles that tried to correct the popular perception that nuclear energy was just for bombs.⁸⁸ Among the peaceful uses of the atom listed by Lilienthal were the control of disease, new knowledge of plants and the workings of the natural world, and even incredibly cheap electricity provided by nuclear power plants.⁸⁹

During the Korean War, 1950-1953, little was heard about the peaceful use of the atom. With the close of that conflict, however, President Eisenhower reopened this potential with his "Atoms for Peace" address at the United Nations on December 8, 1953.⁹⁰ In direct response to this initiative, Congress passed a new Atomic Energy Act in 1954 that essentially amended the original act to allow for international cooperation in the development of atomic energy and in the civilian use of atomic energy. This allowed domestic utility companies to build and operate nuclear power plants.⁹¹ The 1954 Atomic Energy Act not only broadened the scope of the AEC, but also allowed nuclear energy to be used outside of its purview. While peaceful uses of the atom had always been an interest of the AEC, it was now an official part of its charter.⁹²

Purely scientific studies, like the neutrino research conducted at SRP in 1955-1956, were just the beginning of the non-defense mission conducted at AEC facilities. In addition to the Oak Ridge School of Reactor Technology, established in 1950, the AEC sponsored a five-year reactor development program in the mid-1950s, designed to test five experimental reactors for potential use.⁹³ Out of this work came two broad agendas: the breeder reactor program, which was largely for the Navy, which was keenly interested in nuclear power for ships and submarines; and power reactor research for civilian use.

The use of nuclear power for the production of electricity was first done in December 1951 at the National Reactor Testing Station (later, the Idaho National Engineering Laboratory). In 1955, this capability was expanded to

Arco, Idaho, the first U.S. town to be powered by nuclear energy.⁹⁴ The development of commercial power reactors soon spread to selected spots throughout the country, using reactor types that varied from the heavy-water cooled and moderated variety found at SRP and favored by the AEC, to the light water reactors favored by the Navy. Other reactors, like Hanford's N-Reactor, were dual purpose, capable of both nuclear materials production and power.

The AEC favored the development of heavy water power reactors, and the SRP was closely involved in the AEC plans to provide this technology to commercial utilities throughout the country. By the late 1950s, heavy water power reactor studies were commonly produced at the Savannah River Laboratory, and these studies culminated in the design and construction of the Heavy Water Components Test Reactor (HWCTR), built and operated at SRP in the early 1960s.⁹⁵ During this same period, and drawing on technical data obtained from HWCTR, the Carolinas-Virginia Tube Reactor, near Columbia, South Carolina, became the first heavy-water moderated power reactor in the U.S.⁹⁶

Despite AEC efforts to push heavy water power reactors, the example of HWCTR and the Carolinas-Virginia Tube Reactor was not generally emulated in the United States (HWCTR itself was closed down in 1964).⁹⁷ As early as 1962 U.S. utility companies showed a clear preference for light-water reactors.⁹⁸ These reactors, using pressurized light water, were based on research that came out of the U.S. Navy's reactors program, especially the Navy's light-water reactor at Shippingport. Ironically, the AEC "Atoms for Peace" program, which provided partially enriched uranium to commercial reactors, worked against the AEC heavy water reactor program: heavy water reactors might have been more popular if utility companies had been forced to use natural uranium.⁹⁹

Speaking in 1963, Lilienthal described Eisenhower's "Atoms for Peace" initiative as "still alive, but in a wheelchair."¹⁰⁰ While almost surely in reference to the international aspect of that initiative, Lilienthal's comment could be said to apply to the AEC's program to spread heavy water power reactor technology to U.S. utility companies. Despite considerable research and achievements, the program simply did not progress in the direction intended.

With the reduction of the AEC's military mission in 1964, the stage was set for another series of programs to further develop the peaceful use of the atom. These new initiatives were two-fold: provide isotopic heat sources for the U.S. space program, then becoming a major national concern; and contribute to the transplutonium programs that were pushed by Glenn Seaborg, one of the discoverers of plutonium and chairman of the AEC from 1961 to 1971.

Among the isotopic heat sources produced for the space program was cobalt-60, desirable because it did not produce a decay gas.¹⁰¹ Another isotopic heat source requested of the AEC was curium, and the production of this material dovetailed with the transplutonium program.¹⁰²

The heavy water reactors at SRP were pivotal to the transplutonium campaigns, which began with the production of curium during the Curium I program (May-December 1964). The successful attempts to produce curium and other heavier nuclides led to a succession of programs conducted at SRP and coordinated throughout AEC facilities nationwide. These programs included the High Neutron Flux program, both at SRP and at Oak Ridge,

where the High Flux Isotope Reactor (HFIR) began operation in 1965.¹⁰³ Curium II (1965-1967) completed the required production of curium, and provided a start for the most ambitious of the transplutonium campaigns: the production of californium. The Californium I program (1969-1970) was designed to produce enough californium to make the isotope available to industry and private sector interests.

The production of californium went hand-in-hand with the Californium Loan Program, sponsored by the AEC to help create a potential industrial and medical market for this powerful neutron source.¹⁰⁴ Despite the best of intentions, however, most of this work was in vain. Even though samples of californium were distributed to willing participants throughout the country and elsewhere in the 1970s, no viable market developed for what was still an expensive isotope with a relatively limited application.

The problems inherent in the Californium Loan Program were ones that plagued other potential applications of atomic energy for non-military use: the expense was simply more than the limited market would bear. The transplutonium programs, while wildly successful as scientific endeavors, failed to take up the slack left by the reduction in the defense mission. In the case of SRP, the production reactors were just too expensive to maintain and operate for the production of non-defense nuclear materials.

When the defense mission went into eclipse in the late 1980s, the non-defense mission, especially that for production reactors, went into decline as well. The close of the Cold War in 1989 solidified the forecast for Savannah River and the other production sites. The rise of environmentalism in the 1970s had already made inroads into nuclear progress, changing American attitudes about the safety of nuclear production plants and nuclear power plants. The promise of nuclear energy was increasingly called into question and new regulators and environmental regulations were placed into effect. While the ramp up of military might under Reagan characterized the start of the decade, by its close, world affairs and changing public opinion created new missions related to environmental clean-up and restoration rather than nuclear materials production.

ENVIRONMENTALISM, EXPANSION, AND CHANGE AT SAVANNAH RIVER

At the end of the Carter Administration and throughout the Reagan years (1980-1988), there was a resurgence in the production of nuclear weapons materials. This reaffirmation of the nuclear weapons complex was opposed by the environmental movement and then halted by the end of the Cold War. All of this led to conflicting changes at Savannah River Plant, especially in the 1980s. The decade opened with new requirements set by the Department of Defense for plutonium and tritium that directly translated into physical change for the plant. New construction occurred in the process and administration areas to house new programs and personnel, worn facilities were repaired, and technical upgrades were made to operating systems and equipment. Updated security provisions and other physical changes were made with the installation of Wackenhut Services Inc. as the on-site security force.

While SRP expansion was gaining momentum, the environmental movement was also becoming a force that ultimately changed the nature of how the expansion would take place. The accident at Three Mile Island in 1979 drew national attention to the nuclear power industry and reactor safety. The environmental movement hastened change but it was the end of the Cold War in 1989 that shaped new missions for the Savannah River Site.

Rise of Environmentalism

In December of 1974, the Environmental Protection Agency issued the first sanitary NPDES permit for the Savannah River.¹⁰⁵ While this was largely pro forma, it was a harbinger of things to come. In subsequent years, there would be an increase in environmental regulation on federal lands, and Savannah River was not exempt from this trend. In 1976, the Resource Conservation and Recovery Act (RCRA) gave the EPA authority to enforce environmental laws on all Department of Energy weapons-production sites. As a result, regulatory agencies began to weigh in on the previously “closed” controversy over the relative merits of confinement and containment at nuclear reactors, as well as the need for towers to cool reactor effluent water, a feature that was already standard for commercial power reactors.

Despite a promising collaboration in the early 1970s, environmental regulation and the nuclear community did not have the same agenda, and this became clear during the mid- to late-1970s. Environmental regulators soon moved beyond a balanced concern for the environment and the search for new energy sources, and began to micromanage commercial and DOE facilities solely for the benefit of the environment. The nuclear community, long sustained by public awe of atomic power, now began to find itself under attack by a public that increasingly feared the atom and its residual effects. By the late 1970s, the average environmentalist was antinuclear and environmental regulators were responsive to that shift.

Carter, an “environmental president,” was the first to promote alternative sources of energy, such as solar and wind power. The exploration of such avenues was in fact one of the main reasons for the establishment of the Department of Energy in 1977. This exploration did not extend to the nuclear industry. In addition to banning the reprocessing of spent nuclear fuels for commercial reactors, Carter put a stop to the breeder-reactor demonstration program started by Nixon.

In the early 1980s, President Reagan would attempt to revive both the commercial reprocessing of spent fuels and the breeder reactor program, but by this time interest had flagged both in Congress and within the U.S. commercial nuclear industry. The demonstrated abundance of natural uranium certainly played a role in this shift of opinion, but the biggest change would be the accident at Three Mile Island. Even though it was the worst accident to befall the U.S. nuclear industry, its most disastrous impact was in public relations.¹⁰⁶

The impact within the industry was great. Many of the energy concerns and conservation programs conceived in the early 1970s were simply abandoned by the late 1970s and early 1980s. Due to environmental regulations and a lessening demand for nuclear energy that was apparent even in 1979, there was less concern about the uranium supply or the discovery of new uranium sources. This spelled the end of projects like NURE, and effectively put an end to any real demand for the reprocessing of spent nuclear fuels for commercial reactors.

Three Mile Island also had an impact on the nation's production reactors. Up to that point, reactor safety had concentrated on the prevention of major accidents, with an acceptance of certain low-level risks as a requirement of the job. In the wake of Three Mile Island, however, more thought was given to low-probability accidents, and to ways of reducing reactor power levels as well as levels of radioactivity. With this new emphasis, "Loss of Coolant Accidents" (LOCA) became a major concern of the 1980s.¹⁰⁷ With LOCA raised to greater significance, there was a corresponding rise in the importance of Emergency Cooling Systems or ECS. The idea behind the Emergency Cooling System was that even after shutdown, the ECS could still supply cooling water to a reactor in the event of an emergency. Throughout the nuclear industry, and certainly at Savannah River, Emergency Cooling Systems were added to reactors or were augmented in the years after 1979.¹⁰⁸

At the other end of the nuclear process, Three Mile Island also focused attention on the problem of radioactive waste, a dilemma that had never been permanently resolved. There were two types of radioactive waste, low-level and high-level, and both had their unique problems and potential solutions. The Low-Level Radioactive Waste Policy Act of 1980 made every state responsible for the low-level waste produced within its borders. Even though the solution to most low-level waste involved burial, progress in implementing this law was so slow that Congress was forced to amend the act to give several states more time to comply.¹⁰⁹

The problems associated with high-level waste, especially those of the defense industry, were greater and more intractable. Here, simple burial was not adequate, even though the idea of "geological disposal" of high-level waste had been proposed in underground salt deposits and at Yucca Mountain, Nevada, since at least 1957. Storage in high-level radioactive waste tanks was the preferred method of disposal, but this was recognized to be a temporary solution, and never more so than when the first serious leaks began to compromise the tanks in the early 1970s.¹¹⁰ By the end of the decade, it was acknowledged that there would have to be some sort of "Defense Waste Processing Facility" to provide a more permanent solution to the problems of storage.

The Comprehensive Environmental Response, Compensation, and Liability Act (CERCLA) of 1980, also known as the "Superfund" legislation, helped provide the resources to clean up radioactive waste sites around the country. The money came with strings attached. The EPA and the states under authority delegated by the EPA, were given more authority to regulate DOE weapons production sites. The Nuclear Waste Policy Act of 1982, which President Reagan signed into law in January 1983, followed this law two years later. Robert Morgan, manager of Savannah River Operations Office (SROO) between 1980 and 1988, played a significant role in carrying out this act, which required the Department of Energy to establish a long-term site for the permanent disposal of the waste generated by nuclear power plants.

Reactor Upgrades, L-Restart, 700 Area Expansion, and Close of Heavy Water Facilities

Only four of the nation's production reactors were in operation in 1980: SRP's P, K, and C and Hanford's N reactor. Plutonium irradiated in N reactor had a high concentration of plutonium-240 that was unsuitable for weapons grade material. This shortcoming could be corrected by blending it with plutonium that had a lower concentration of plutonium-240 and SRP was directed to produce the proper plutonium for blending. A program to recover scrap plutonium at Rocky Flats in particular also had ramifications for SRP Operations. In order to

comply with the change in product needs, SRP was compelled to upgrade and modernize its three operating reactors to allow them to attain higher power levels within shorter cycles. In 1980, one assessment cited the following problems: one-quarter of the reactor heat exchangers were irreparable due to wear and aging; plant facilities had obsolete and worn out instruments and controls, not only in the reactors but in other plant areas as well; that the needed parts could seldom be replaced in kind; and finally there were too few engineers available to design modern equivalents.

To begin to refurbish the Site's facilities, a five-year Restoration Program was established and funded at \$350 million dollars, which was to be dovetailed with a \$300 million dollar Productivity Retention Program by Du Pont. The Restoration Program did not include capital funds needed for new construction such as the Defense Waste Processing Facility (DWPF) discussed below but was the source of funding for L-restart and other upgrades.

By 1983, SRP's engineers were successful in this endeavor as the reactors reached the needed power levels, exceeding expectations. In addition, Du Pont was directed in 1981 to reactivate L reactor, a project that, when completed in 1984, brought L reactor to a safety and dependability level comparable to that of the three reactors that had



The L Reactor Startup Team was the first management group to be placed under Du Pont's "program management" organizational philosophy. The program management structure was applied plant-wide in 1982. Courtesy of SRS Archives, negative 34872-3.

remained in operation and had been continually upgraded. Employees in the 300 Area worked a seven-day workweek to keep up with the pace the higher power level in the reactors warranted and in anticipation of L reactor startup.¹¹¹ This was a major initiative budgeted at \$214 million, employing a peak workforce of 800 for the renovation efforts, and projected to employ an operating workforce of 400 to run the reactor. It was also the first time that a reactor on standby had ever been refurbished and restarted after being out of service for more than a decade. The reactor was refurbished with new heat exchangers, replacement piping, removal of aluminum-nitrate from the reactor tank and nozzles, and the addition of safety upgrades. The challenges for the Restart Program stemmed from environmental rather than technological challenges.

DOE had completed an internal study of all associated environmental issues involved with the restart program, but chose not to follow the Environmental Impact Statement (EIS) procedure that provides for public hearings. This choice, characteristic of an agency committed to the "need to know" ethic, led to great controversy as local and national environmental groups called for action. Senator Strom Thurmond held local hearings in response as part of the Armed Service Committee's responsibilities that demonstrated the controversy production reactors could evoke by the 1980s.¹¹² By the close of 1983, it was recognized a lake would have to be constructed, not to impound cooling water, but to cool effluent water leaving the reactor before it would enter the Savannah River Swamp. L Reactor was finally re-started in 1985. It operated less than three years before it was shut down again. During its period of operation, its output was often constrained by the environmental requirement to limit the temperature in L Lake to 90 degrees F in the summer months.



(Above) Aerial View of P Reactor, 1989. Courtesy of SRS Archives, negative 89-2074-7

(Right) Detailed Aerial View of P Reactor.

(Below) At the close of the decade all five of Savannah River's reactors were shut down. P Reactor had earned the designation of "World's Safest Production Reactor" with its impeccable safety record spanning almost three decades.

"When we started using these reactors down here, the commercial nuclear business hadn't been invented yet. We had five reactors going—and commercial power reactors were just a gleam in the scientist's eye. So everything we did was pioneering—there was no real road map for us."

- Gerry Merz

Source: "Reacting to Change," *The Augusta Chronicle*, November 6, 2000.



The process areas were not the only focus of upgrades and new construction in the 1980s. The main Administration area was expanded under a long-range building program that aimed at replacing trailers with administrative facilities.¹¹³ Between 1980 and 1989, nine buildings were added to the Upper 700 Area to ameliorate working conditions. Others were also added to F and H areas. The design and building materials used in this construction was based on obtaining the most space for the available money. The buildings were considered “Local Practice Commercial Standard Office Buildings” and were let to bid as “Design-Build” projects.

Another change in the 1980s was the closure of the last of the Heavy Water production units in 1982. The area was in operation for slightly over 29 years, and had produced a sufficient amount for the needs of the Site’s three operating reactors. Heavy water produced at SRP was sold to foreign countries and domestic consumers for a variety of uses and it, along with timber, was a revenue producer for SRP. For example, the AEC negotiated the sale of 450 tons of heavy water valued at \$42 million dollars in 1969.¹¹⁴ Over 6,000 tons were produced during D Area’s years of operation.¹¹⁵

Defense Waste Processing Facility (DWPF) and Naval Fuels Program

Two additional programs were also started in the 1980s concurrent with the restoration program further exacerbating financial and manpower deficiencies. The DWPF got underway as did the Naval Fuels Program.

The long term problem of defense wastes was tackled in the early 1970s when scientists began to research for a solid waste form and a process by which defense wastes could be converted and stored in that form. Glass was selected after much research. The

converted waste once vitrified would be encased in stainless steel canisters for permanent storage. Radioactive materials in the waste tanks were separated from nonradioactive materials through chemical separation processes that allowed the remaining sludge of radioactive materials to be sent to the DWPF Building, a monumental reinforced concrete building about 360 feet in length, 115 feet in width and 90 feet in height, for vitrification. Modeled after the canyons, most of the process work that occurs in this facility is conducted remotely behind heavy shielding. The salt that remains after the separation process is dissolved in water, cesium-137 and strontium-90 are precipitated and filtered then sent over to DWPF as a slurry for vitrification. The remainder, a salt solution,



Aerial View of DWPF Building 1977. Courtesy of SRS Archives, Negative 97-1527-1.

is hardened into a cement-like substance by mixing it with fly ash, furnace slag, and Portland cement. The final product called “saltstone” is placed in long concrete enclosures in Z Area. Construction began in 1984 but would be hampered by a lack of funding. The facility was complete in 1989 and actual vitrification began in 1996.¹¹⁶

The Naval Fuels program was aimed at converting uranium feedstock into useable fuel in support of the Navy’s nuclear propulsion program. Facility 247-F housed the processes involved in this conversion; it was constructed and deactivated before it went into operation.

The scale of the needed repairs and the new construction engendered by the Naval Fuels and the DWPF facilities was prodigious. Moreover, the timing was awkward. In historian Bebbington’s words, all of these programs were coincident with the first generation of SRP employees reaching retirement age, compelling Du Pont to hire and train a new workforce that was in size and in scope comparable to that of 1950. The major departure in the 1980s from the 1950s was the hiring of outside contractors to fill the needed gaps in the Du Pont team.

A second large change in staffing came about in 1984 when DOE requested that a specialized security force be designated for plant protection that would be able to respond to the changing world order. Prior to 1984, Du Pont handled site security. The Du Pont security force was disbanded and security of the plant was transferred to Wackenhut Services, Inc. in 1984. At this time, physical barriers protecting restricted areas were enhanced and security measures were updated.¹¹⁷

Reactor Shutdowns and Du Pont’s Departure

In 1986, a coolant system assessment indicated a situation could arise in which insufficient amounts of cooling water would be available to the reactors in an emergency situation. The power levels of the reactors were decreased by 25 percent in November of that year. Then, in early 1987, a special panel of the National Academy of Science set maximum reactor power levels to about 50 percent of normal full-power operations.

By this time, Du Pont was clearly interested in pulling out of the atomic energy business. In October 1987, Du Pont formally announced that it would not seek to renew its contract with the Department of Energy, scheduled to expire in early 1989. The rationale for their departure was first that the government no longer appeared willing to guarantee the work and that Du Pont was no longer uniquely qualified to do it. Following almost immediately, there were safety hearings before a House subcommittee.¹¹⁸ Since the mid 1980s, DOE and its contractors had been under examination in Congress for allegations of poor safety practices at federal nuclear facilities. In hearings before the Subcommittee on Oversight and Investigations of the House Committee on Energy and Commerce, Savannah River was noted for its poor fire prevention procedures. Congress wanted sprinkler systems installed in the reactor buildings, and this was a government expenditure that SROO and Du Pont management had resisted for the simple reason that the all-concrete reactor buildings could not burn.

The concern over fire prevention was eclipsed by a news story reported on the front page of *The New York Times* in 1988. A report, “SRP Reactor Incidents of Greatest Significance” compiled three years before, which detailed and categorized 30 significant incidents in the history of the five Savannah River reactors, was released to the

public. Most of the incidents in the 1985 report had been summarized in an earlier ERDA document. An internal memorandum initially, the report's purpose was to show that the serious reactor incidents at the Savannah River Plant were largely confined to the early years of operation, and that the safety precautions of later decades had greatly reduced the incidence of error. The 1988 report was released in an effort to show that nuclear work was in fact becoming safer. This was not how the information was received, and the national media immediately interpreted 30 "incidents" as "accidents." The outcry over the disclosure led to further congressional hearings over perceived problems at Savannah River. Media attention reached a peak in late 1988.

Responding to ever-tougher safety regulations and a relatively large stockpile of nuclear materials, the Department of Energy shutdown the three remaining reactors, P, K, and L in 1988. The fact that the Savannah River reactors had all been shut down was almost lost in the public debate. Although this shut down was initially intended to be temporary, it soon became permanent. In March 1987, administrative limits were placed on the power levels at K, L, and P reactors due to lingering uncertainties over the Emergency Cooling System (ECS). The following year, all three were shut down due to continuing concerns over the ECS, as well as the possibility of a "loss of pumping accident" or a "loss of coolant accident." K reactor was the first to go, in April 1988, followed in rapid succession by L in June and P in August. The ripple effect of these shutdowns passed through other areas of Savannah River as well. The production of fuel tubes ceased in Building 321-M that same year.

When Westinghouse assumed Du Pont's mantle in April 1989, all the reactors were shut down, and the U.S. had ceased the production of weapons-grade fissionable material altogether. The Site was officially included on the National Priority List and became regulated by the Environmental Protection Agency. In the same year, the Department of Energy formally announced that its primary mission had changed from weapons production to a comprehensive program of environmental compliance and cleanup. In a signal that it was making a break with the past, the facility's name was changed from the Savannah River Plant to the Savannah River Site.

Later attempts to use the reactors for further production were half-hearted. Even though L Reactor was selected as a backup for tritium production (1990), and K Reactor was restarted for power ascension tests (1992), the Department of Energy ordered both reactors shutdown with no capacity for restart in 1993.¹¹⁹ While the work of nuclear processing continues in the Separations Areas and other places on-site, the SRS reactors themselves are now used to warehouse discarded radioactive materials.

End of Cold War

The controversy over "Star Wars," not to mention conflicts in Afghanistan and Nicaragua, kept the Cold War fairly warm in the early 1980s. There was also a confrontation over missile deployment in Europe. It was in this context that the L Reactor Restart program was initiated and completed. By the mid-1980s, however, Soviet society was beginning what would turn out to be a permanent thaw. Yury Andropov, Brezhnev's successor, died in 1984 after only a couple of years in power, and was eventually succeeded by Mikhail Gorbachev in 1985. Within a year, Gorbachev became the first Soviet leader to openly admit the weakness of his country's planned economy. More remarkably, he was the first Soviet leader to admit that elements of the old Communist doctrine were wrong or, at

the best, outdated.¹²⁰ By the late 1980s, Gorbachev was well into the programs now associated with his name: *glasnost* (openness) and *perestroika* (economic and political restructuring of the old Soviet system).

The nuclear accident at Chernobyl played a role in this development. After first denying the accident, Soviet authorities soon made a complete turn-around, with relatively open disclosure of the problem and solicitations for foreign assistance. The approach to Chernobyl paved the way for new approaches to other problems. In December of 1987, the U.S. and Soviet authorities signed an agreement to eliminate all land-based intermediate range nuclear missiles from Europe. More was to follow in almost dizzying succession. In the fall of 1989, the Berlin Wall, symbol of the Cold War in Europe, was dismantled, permitting a rapid reunification of Germany. Communist regimes collapsed throughout Eastern Europe. Within two years, in 1991, the Soviet Union itself would collapse, leaving the former giant split into its various constituent republics. Gorbachev, now jobless, was forced to bow out to Boris Yeltsin, the president of Russia.

In the decade that followed, there would be additional problems with Russia as its economy continued downward, but there would no longer be the threat of an ideologically fueled nuclear war between the two great superpowers of the Second World War. Now it was the time to take stock of the vast nuclear arsenals in both countries, and initiate a general clean up of forty years of nuclear production. Savannah River Site, under the aegis of the Westinghouse Savannah River Company, was already poised to head in that direction.

The purpose of this chapter was to present a contextual overview of Savannah River Site's Cold War history, from a national and site-wide perspective, with the goal of providing background for the succeeding narrative. The following chapters deal with the history of heavy water production at the Dana Plant and D Area at Savannah River.

III. EARLY HEAVY WATER RESEARCH

Heavy water was an important research topic from the 1940s onward as scientists involved in atomic energy research recognized that it could be used to slow neutrons from fissioning uranium. The beauty of heavy water as a moderator for a nuclear reactor was the ability of its deuterium atoms to absorb energy from neutrons that collide with them without uniting or capturing too many neutrons. This capacity would allow a sustained chain reaction in production reactors using natural uranium as a fuel. Interest in this use followed close on the heels of the discovery of the isotope deuterium but scientific investigations into the nature of heavy water had to occur first. This chapter discusses this important period and the research that led to the selection of heavy water as a reactor moderator for the AEC's expansion program in 1950.

Heavy water is water that has a greater proportion of heavy hydrogen atoms to ordinary hydrogen atoms. It occurs naturally but in small quantities. It is estimated that about one part of heavy water exists in every 7,000 parts of normal water. Typically, a water molecule has two atoms of hydrogen and one of oxygen. While most share this composition, some water molecules are different. They contain another hydrogen isotope known as deuterium as well as oxygen. Deuterium is identical to hydrogen except that it has a neutron in its nucleus, making heavy water heavier than normal water by about 10 percent. Heavy water is called deuterium oxide or notated as D_2O , indicating its composition.¹ The small amount of deuterium in nature is the challenge as the isolation of large amounts of heavy water is costly and complicated.



Harold Clayton Urey (1893-1981)

Urey, an Indiana native, was awarded the degree of Ph.D. in Chemistry in 1923 at the University of California. After a year at Professor Niels Bohr's Institute for Theoretical Physics as American-Scandinavian Foundation Fellow to Denmark, Harold Urey became an Associate in Chemistry at Johns Hopkins University. In 1929 he was appointed Associate Professor in Chemistry at Columbia University and he became Professor in 1934; during the period 1940-1945 he was also Director of War Research, Atomic Bomb Project, Columbia University. He moved to the Institute for Nuclear Studies, University of Chicago in 1945 as Distinguished Service Professor of Chemistry. In 1958 he returned to the University of California as Professor-at-Large. Source: http://nobelprize.org/nobel_prizes/chemistry/laureates/1934/urey-bio.html.

In the early twentieth century the composition of water was not well understood and as late as 1913, scientists were stymied with definitive values for the density of water. Researchers at New York University are credited with the first reported experiment that indicated that an isotopic difference in properties might be involved. The existence of isotopes was actually announced by Frederick Soddy of England and Kasimir Fajans in Germany also in 1913. In 1931, American researchers would suggest that isotopes of hydrogen might have something to do with differences in atomic weights. Harold Urey, then at Columbia University, and his associate George Murphy, followed up this research and in the same year they were able to demonstrate the existence of deuterium. The Columbia scientists achieved this using fractional evaporation of liquid hydrogen to separate the isotopes. At this point, deuterium was referred to as "heavy hydrogen."² It would later be named deuterium by Urey after consultation with professors in the Department of Greek and deuterium was chosen for the neutron in its nucleus.

While Urey was credited with the discovery, Gilbert Newton Lewis at Berkeley would further knowledge of the new isotope. Lewis with his research assistant Ronald T. MacDonald, used electrolysis to concentrate deuterium oxide from a large quantity of water. Their production spurred early heavy water research that was devoted to discovering more about the two isotopes and their compounds and to evaluating deuterium's possible use as a tracer in biochemical processes and chemical reactions. The demand for heavy water was small, but it was produced commercially as a sideline industry within manufacturing plants that were already producing hydrogen and oxygen electrolytically. The Norsk Hydro plant in Vemork, Norway, the largest electrolytic hydrogen plant in the world in the 1930s, was producing heavy water by 1934. Historical documents show that the Norwegian plant shipped heavy water to researchers around the world, including Harold Urey at Columbia.³

By 1940, interest in heavy water heightened as scientists began to research its potential as a neutron moderator. A research and development program established at Columbia University under Urey began to investigate how heavy water could be mass-produced. This research, under the auspices of the Office of Scientific Research and Development, was carried out at other American universities and in industrial research laboratories as well.⁴

After obtaining funding, Urey set up a pilot plant in Louisiana that was operated by the Standard Oil Company. The pilot plant was charged with studying the liquid–gas phase exchange reaction under high pressure, while Urey worked on developing a catalyst.⁵ Heavy water research continued, but the effort moved from Louisiana to Canada. In a cooperative effort between the United States, Britain, and Canada, Harold Urey worked with Hans von Halban, who was to head a heavy water research program for the British. The program was located at Trail, British Columbia, near the American–Canadian border. An existing hydro-powered, electrolytic-hydrogen plant for ammonia production was in operation at Trail, owned by Consolidated Mining and Smelting Company of Canada LTD (Cominco). Cominco converted a loop in their ammonia plant for heavy water production. By mid-June the plant had produced enough deuterium for Enrico Fermi to make measurements that proved that deuterium was an excellent moderator.⁶ Unfortunately, the conclusive tests occurred six months after Fermi's success at the University of Chicago's Stagg Field. Once CP-1, the first graphite-moderated reactor, went into operation, heavy water research was "relegated to a secondary role as the moderator for the second generation of nuclear reactors."⁷

Heavy water production continued at three heavy water plants, called P-9 plants, operated by Du Pont during the war. Du Pont successfully produced 32 tons of heavy water at their wartime plants. The chemical firm used excess steam from existing Department of War facilities at Morgantown, West Virginia; Childersburg, Alabama; and Newport, Indiana, to operate the plants. An electrolysis unit for final concentration and purification that served all three plants was located at Morgantown.

The Du Pont heavy water facilities operated for two years, producing collectively 2,400 pounds of 99.8% heavy water each month. Wartime production included vacuum distillation of water followed by electrolysis for final concentration, because these processes offered little risk of failure and the needed materials were available. "The Columbia group and the Du Pont engineers who designed the wartime plants believed that stainless steel would be the only satisfactory material of construction for the H₂S process; the quantities required would have been prohibitive. After contemplating the building of a small demonstration plant, they set the dual-temperature process

aside."⁸ At the close of the war, sufficient heavy water had been produced for Argonne's planned heavy-water-moderated test reactors, so the Du Pont units were closed down.

Between 1940 and 1945, five primary separation techniques for recovering heavy water had been developed: distillation of hydrogen, fractional diffusion of hydrogen gas, electrolysis of water, distillation of water, and gas-liquid exchange processes (both dual- and single-temperature processes). In 1942, a dual-temperature, single-stage chemical exchange method of concentrating deuterium in an H_2O/H_2S system was completed in glass on a bench scale at the SAM laboratories at Columbia University.⁹ Jerome Spevack, working in the Columbia University laboratory program, patented the dual-temperature process at this time and suggested its use with the water-hydrogen sulfide system.¹⁰ Work on the development of the dual-temperature process at Columbia was suspended after 1943. While laboratory-scale tests and some corrosion work had been accomplished, a

WHY HEAVY WATER IS SO GOOD

Source: Savannah River Laboratory, Nucleonics of Tomorrow in the Making Here Today, promotional booklet, not dated.



Hheavy water slows fission neutrons to thermal energies without absorbing them. It does this important job more efficiently than any other substance. Its moderating ratio, $\Sigma_s \xi / \Sigma_a$, is 70 times that of graphite, the next best moderator. Being a liquid, it can serve as both coolant and moderator. For experimental work, it is wonderfully flexible. You don't have to drill holes in *this* moderator!



With heavy water, natural uranium can be used as fuel. Enriched uranium is not necessary. Power systems based on D_2O have important economic and politico-economic potentialities. They are being developed with vigor, particularly by the United States, Canada, Norway, and Sweden. Production systems based on D_2O show unsurpassed neutron economy.

semiworks demonstration of the process, which became known as the GS process, did not progress beyond the planning and design stage.¹¹

The selection of heavy water as a moderator for the new reactors for the AEC expansion program in 1950 reintroduced investigations into the three potential production processes that could increase the one part in 7000 of deuterium in plain water by a hundredfold. These were vacuum distillation of water, distillation of liquid hydrogen, and exchange of liquid water with hydrogen sulfide (H_2S) gas in a dual-temperature cycle.

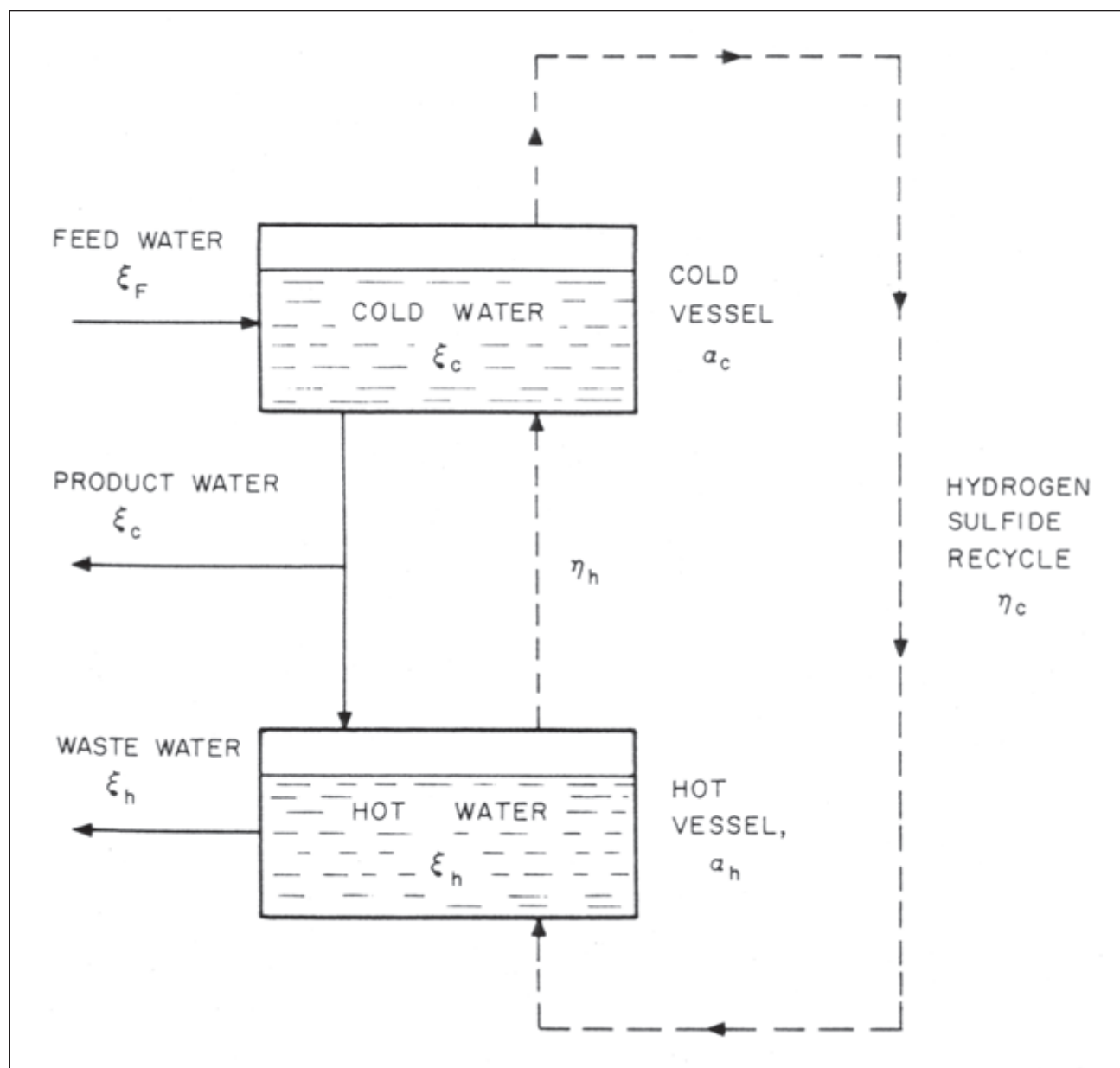

Dual-temperature Principle – Conceived and patented by Jerome Spevack during the Manhattan Project, the dual-temperature process was considered for use with a water-hydrogen sulfide system to produce heavy water. However corrosion issues would argue against its selection as a possible neutron moderator until 1949 when large quantities of heavy water were needed making the process feasible economically. Source: "Separation of Isotopes of Hydrogen and Other Light Elements," Nuclear Chemical Engineering (Date: 769).

The drawbacks on each were studied and compared in the light of the impending events and the availability of materials.¹²

In 1949, the Girdler Corporation, a Louisville, Kentucky-based firm, was asked to study the feasibility of converting the old Du Pont P-9 facility at the Wabash River Ordnance Works (WROW) to a low-pressure dual-temperature production plant under the guidance of the AEC's New York Operations Office. Given that the WROW facility was designed for vacuum operation, it could not be converted into a high-pressure production system. It was estimated that the converted plant could produce 2.5 tons of heavy water per month at lower pressures.

In a report (NYO-681), Girdler recommended that a new, more efficient, high-pressure facility could be constructed at the same cost as the conversion of the existing facilities.¹³ Girdler also reviewed a report to the AEC (NYO-508) by Jerome S. Spevack, titled "Pilot Plant Testing of the Dual-Temperature Heavy Water Process."¹⁴ Spevack, a member of Urey's group at Columbia University in 1942, had been hired as a consultant by the AEC in 1948 to prepare a report on the dual-temperature process for isotopic concentration. Spevack improved his 1942 design by increasing heat efficiency with interstage cascading.¹⁵ The Girdler review stated that the process suggested by Spevack appeared technically feasible, and it recommended pilot-plant tests. Reuse of the federal property in Indiana and some of the original P-9 facilities would substantially reduce costs that had heretofore been considered prohibitive.¹⁶ If the pilot-plant tests at WROW were successful, then the facility could be expanded.

While Girdler's studies were ongoing, the AEC also funded work with the hydrogen-distillation process, requesting that Hydrocarbon Research, Inc., design a plant based on this process. On March 1, 1950, the commission approved construction of the second pilot plant. In this design, hydrogen gas would be cooled to liquid temperatures and fractional distillation would be used to separate deuterium from the gas.¹⁷

When Du Pont contracted with the AEC to construct the Savannah River Plant, they evaluated the three methods and decided that the Girdler sulfide (GS) process showed clear advantages, as long as three drawbacks were addressed. These drawbacks were: difficulty in process control, the toxicity of the gas, and its tremendous corrosive power. Du Pont's engineers began to work cooperatively with Girdler personnel in the design and later operation of the Dana Plant, which was situated at the WROW. Girdler's primary engineers on the project were R. M. Reed, E. A. Comley and N. Updegraff. In a critical meeting between the two firms in early November of



Vintage Girdler Corporation Advertisement. Source: http://www.surveyhistory.org/surveyors_in_advertising1.html.

1950, Du Pont's Explosives Department was represented by V. R. Thayer, D. F. Babcock, W. P. Bebbington, J. B. Tinker, W. H. Holstein, A. J. Schwerfeger, and M. S. Bloomsberg. The Engineering Department sent S. I. Winde, J. M. Hoffman, A. E. Daking, and A. K. Shaddock for design; C. S. Robinson and R. T. Matthews for power; H. E. Houck for electrical; E. B. Showell and C. S. Moore for water treatment; and J. R. Boyer as a specialist on blower seals.¹⁸ The strength and numbers of the Du Pont team underscored how important the design and construction of the pilot plant was to the overall Savannah River Project.

Girdler had become a subcontractor to Du Pont on November 1, 1950. Its scope of work was to design and initially operate the pilot plant until December 15, 1950, when it would be turned over to Du Pont's operations staff. The main production facilities at Dana were by contract to include six Girdler Sulfide (GS) units, each with a capacity to produce 40 tons of heavy water per year, a distillation (DW) plant, and an electrolytic (E) plant. This projected output was considered sufficient to put Savannah River's two proposed reactors in operation. The acronyms, "GS," "DW," and "E" will be used in the following chapters to denote the equipment associated with each process. Over time, the large towers became known simply as GS towers; the full moniker "Girdler Sulfide" was only used in process descriptions. The same naming process occurred with the DW and E plants.

The ordnance works property, located west of Indiana State Highway No. 63 in the east central portion of the WROW reservation, had been the site of one of Du Pont's largest wartime heavy water production sites.

At this point, Du Pont joined Girdler with primary responsibility for oversight of design and development activities, including operation of the pilot plant to demonstrate operability and process control. Du Pont's experience with hazardous materials gave optimism that dedicated safety procedures and equipment could handle gas toxicity, and an extensive corrosion research program was initiated within the Du Pont Engineering Research Laboratory to confirm and extend preliminary conclusions that conventional materials of construction could be used. Du Pont engineers worked with Girdler on process design and materials of construction. Girdler engineering personnel were very capable and cooperative, and this collaboration worked well. Construction of the pilot plant was nearing completion and about a dozen Du Pont people were transferred there to oversee operations. We were there on duty in late November 1950, when the Savannah River Site was announced. That heavy water facility soon became known as the Dana Plant, named for the nearby village of Dana, Indiana.¹⁹

IV. DANA PLANT

The Indiana plant site was situated on 57 acres within the military reservation that incorporated the six acres on which the older Du Pont P-9 plant was located.¹ Girdler had started construction of the pilot plant on June 26, 1950. As noted, Du Pont's contract that started on November 1, 1950 encompassed the construction and operation of the Dana Plant. Girdler's contract with the AEC was essentially terminated and their services were picked up by Du Pont.

Under the new arrangement, Girdler was to complete the pilot plant and the rehabilitation of the existing powerhouse, the Ranney wells and part of the original P-9 facilities.² They were also to continue operation of the plant, powerhouse and associated facilities through December 1950 when it was to be formally turned over to Du Pont. Key personnel with Girdler would remain into January to assure that the transition was successful.

Dana's construction involved thousands of workers at the peak of construction in July of 1951 with steamfitters strongly represented among the labor force. A history of the construction notes that this period created a boom for local communities, particularly Clinton, as they strove to absorb the construction force that did not have housing in the Dana associated trailer parks. Newport, Montezuma, Rockville and Terra Haute in Indiana as well as Danville, Illinois, felt the crunch.³

The construction era buildings used temporarily then exceeded, gave way to the permanent architecture. Voorhees, Walker, Foley & Smith (VWF&S) provided architectural services for the following buildings: the Product Storage Building (Building No. 303), the Gate House, Guardhouse and Clock Alley Building (701), the Administration Building (703), the Cafeteria (704), The Technical Office and Laboratory Addition (705), the Garage and Automotive Repair Shop (706), the Shop, Stores, and Change House (707), the Paint Shop (708) and Material Storage Building (709). The Lummus Company was responsible for the Water Treatment Plant (103), DW Intermediates (212), the Finishing Building (301) and the Flare Tower (210). Both VWF&S and the Lummus Company were involved with the construction and design of SRP facilities.⁴

Girdler provided an apt description of the plant in 1952:

The Dana Plant has much the appearance of a large oil refinery, in that the principal production units area series of tall towers, interconnected by piping with pumps, blowers, heat exchangers, and other auxiliary equipment. The operating platforms are steel structures and weather protection to the process is afforded by insulation.⁵

The unhoused towers were joined by a complement of utilitarian support structures that had steel frames, concrete foundations, and were sheathed in corrugated asbestos board. The overall plan of the plant was described as compact in that all areas were in easy walking distance to the gates. There were six subareas: 100, 200, 300, 400, 500, and 600. The 100 area was devoted to auxiliary facilities for the storage of raw materials and generators. Its 200 area consisted of six GS tower units, instrument and switch buildings, mass spectrometer buildings, weigh tank buildings, a flare tower, pilot plant, concentrator building and an air sampling system.

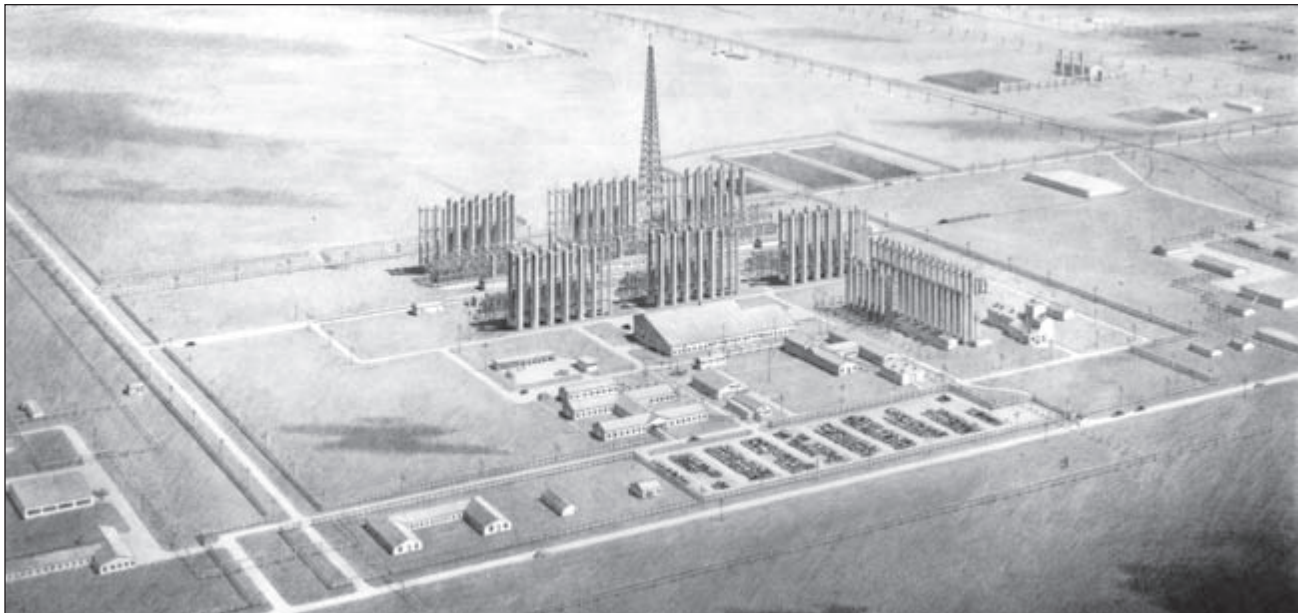

Dana Plant Layout Completed by Voorhees Walker Foley & Smith, 1950. Courtesy of the Hagley Museum and Library, Du Pont's Atomic Energy Records, PO 2000-110.



Aerial of Dana Plant.

(Opposite) A - Workers at the Dana Plant assemble in front of Safety Platform to hear a briefing on construction of SRP. Source: The Indianapolis News January 17, 1952; B - Advertisement for Dana Plant, Danville Commercial News, February 26, 1952; C - Safety Platform, 1952. Source: The Girdler Corporation. Dana Plant Construction History, DuPont Project 8987. (Wilmington, Delaware; E. I. du Pont de Nemours & Do., 1952); D - Dana's Management, 1952. R. Page Kelly would replace Don A. Miller who was transferred to SRP to manage the new plant. Source: Danville Commercial-News, February 28, 1952; E - "War Plant Officials Speak" - Officials of the Wabash River Ordnance Works (WROW) were the principal speakers at a civic meeting sponsored by the Lions Club. Standing left to right, Clarence Wright, Mayor; Nick Karonovitch, Chairman of meeting; J. A. Ruth, production manager of the Liberty Powder Company operations at the plant; Raymond Medlock, civic leader; Omar McMaster WROW official; R. P. Kelley of the DuPont Company, Dana area; C. W. Reilly, area manager of the Dana Plant of the AEC; and Major B. A. Rayfield, executive director of the WROW. Lions Club members are seated in front. Source: The Terre Haute-Tribune Star, December 14, 1952.



R. Page Kelly Heads Dana AEC Plant



R. PAGE KELLY

R. Page Kelly, 50, of 212 Prairie St., has been appointed manager of the Atomic Energy Commission's Dana plant near Newport, the DuPont Company, operators of the plant, announced Thursday.

Dr. J. A. Monier Jr., Terre Haute, has been named assistant manager. Kelly succeeds Don A. Miller of Chrisman who has been appointed manager of the AEC's Savannah River plant.

Kelly has been assistant manager of the Dana plant since November, 1950. A native of Salem, Va., and graduate of Virginia Polytechnic Institute in 1929, he joined DuPont's explosives department at Pompton Lakes, N. J., the same year as repairs engineer.

He was appointed assistant manager in 1939, a position he held until September, 1943, when he was loaned to another company for war work.

He rejoined DuPont in 1945 as assistant manager of the Birmingham, Ala., plant. He returned to Pompton Lakes in a similar capacity in 1949.

Dr. Monier, 44, a native of Somerville, Mass., came to the Dana plant in May, 1951, as technical superintendent from DuPont's Sabine River Works in Orange, Tex.

B YOU!

**MAY QUALIFY FOR A
VITALLY IMPORTANT
ATOMIC ENERGY JOB**

- ★ Skilled Area Mechanic
- ★ Skilled Pipe Fitter
- ★ Skilled Millwright
- ★ Skilled Mechanist

**VITALLY NEEDED FOR
IMMEDIATE PLACEMENT**

- ★ Safe Working Conditions
- ★ Promotion and Advancement
- ★ Stability and Security
- ★ Good Wages

DU PONT EMPLOYMENT

Office Hours — Mon. Thru Fri.
8 O'Clock — 3 O'Clock

Dana Plant — 2 Miles South
Newport, Ind. — Route 63

APPLY NOW!



The 300 area was considered the finishing and storage area. It contained two buildings: the “E” or electrolytic process finishing building and a storage facility for heavy water. Power generation facilities were considered the 400 area, electrical lines the 500 area, and the 600 area was composed of “general” facilities.⁶ Water was supplied from the Ranney wells that were located along the Wabash River and electricity was supplied by the Public Service Company of Indiana. The reactivated powerhouse provided steam for heat and air.

HEAVY WATER PRODUCTION AT DANA

The production facilities at Dana reflected the concept developed by Girdler under its original contract with the AEC. Water from the Wabash River was fed into six GS units (a total of 96 towers), each having five stages of cold-hot tower systems. The first stage of each unit contained four pairs of parallel hot-cold towers that were 120 feet high, 11 and 12 feet in diameter, and contained 70 separative trays. The second stage had one tower set

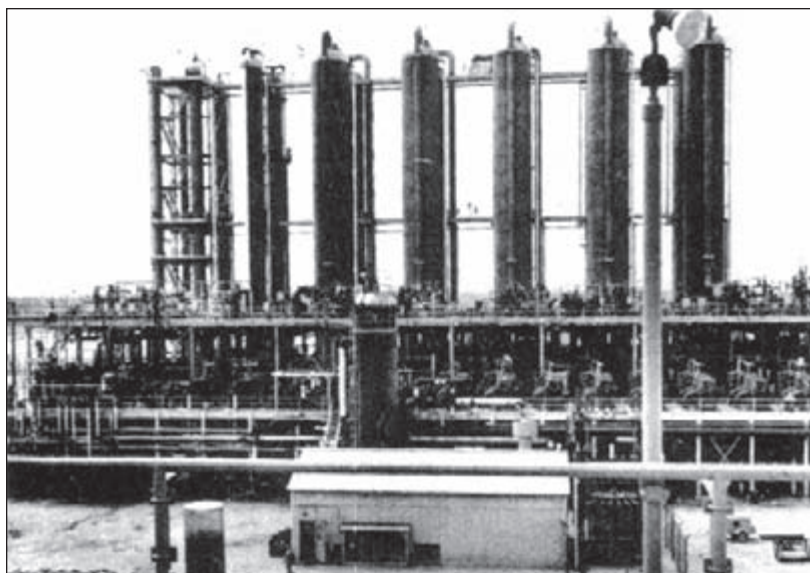

This view shows the GS towers in the background. Each pair of cold towers is almost obscured by the hot towers. From right to left are four first stage pairs; second, third, fourth, and fifth stage pairs. The lowest level contains the heat exchangers and the short tower in front is the waste stripper. The small building houses an electrical switchgear room. Source: E.I. du Pont de Nemours & Co, Savannah River Laboratory, Production of Heavy Water Savannah River and Dana Plants Technical Manual, July 1959, DP-400, 19.

with the same dimensions as the first stage, and the remaining three stages involved towers of equivalent height but decreasing diameters, 6 feet at the third stage and 2.5 feet at the fifth stage.⁷ The gas and liquid streams from the first-stage tower pairs were combined for heating and cooling and then redistributed among the towers.

At the heart of the GS process was a pair of gas-liquid contacting towers, one of which operates at 30 to 35° C (the cold tower) and the other at 120 to 140° C (the hot tower). Ordinary water enters the system, flows downward through the cold tower and then upward through the hot tower, all the while flowing countercurrent to a stream of hydrogen sulfide gas. The towers are stacked with “bubble-cap trays” that force the gas to pass through the water. Deuterium is absorbed

Each GS tower was stacked with bubble cap trays that forced the gas to pass through the water. Savannah River’s first stage GS towers (24 cold and 24 hot) had 70 trays in each cold tower and 60 in each hot tower. The cold towers were 11 feet in diameter; hot towers were one foot wider. Source (image): McGraw-Hill Dictionary of Scientific and Technical Terms, editor Sybil P. Parker, Fourth Edition, New York.

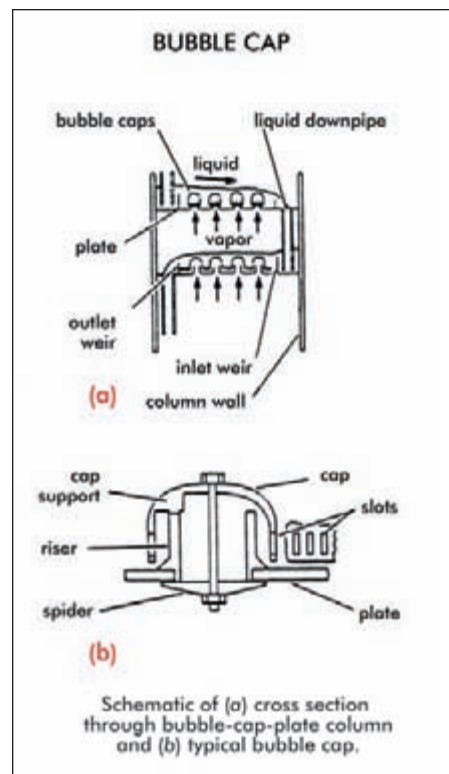

from the gas in the cold tower, and stripped from the liquid in the hot tower. Having completed a stage, the concentrated deuterium can be withdrawn from the base of the cold tower and from the top of the hot tower for use as the “product” as is, or can move on to a second stage to be further concentrated. The hydrogen sulfide gas, which is the transport medium for deuterium, circulates in a closed loop within the process.⁸

At Dana, a major problem with the process as envisioned—process control—was solved. For the system to work, very tight control of the ratio of flows of gas and liquid was needed. Bebbington states that the ratio had to be precisely that called for by process theory.⁹ Deviation from that control led to poor productivity, and instrumentation at that time was not able to ensure operation of the optimum ratio. Dale F. Babcock, the senior member of Du Pont’s task force at Dana, solved this dilemma. Babcock observed that if the concentration of deuterium at the middle plate of the cold tower is the same as at the middle of the hot tower, then the flow ratio was correct. This principle—the comparison of mid-column concentrations as a basis for process control—was used to guide the pilot planning, and the ratio was used regularly during production.¹⁰

More information about the GS process evolved as the research at Dana moved forward. A first stage was built, composed of two steel towers, each 3 feet in diameter and 110 feet in height with 70 bubble-cap or separative trays. Successful operation of the first unit occurred on October 26, 1950, slightly more than a month before the Savannah River “announcement.” At this point, Du Pont’s engineers, Dale Babcock, C. B. Buford and J. W. Morris, were referring to the GS process as the “S” process. The first 300 hours of operation demonstrated the effectiveness of the Babcock ratio and determined that the bubble-cap trays were at least 45% effective in the two-column test system. Their summary was understated, “Taken as a whole, the pilot plant operations and data were judged adequate to justify the choice of the GS process for the production plant.”¹¹

Due to operational considerations and the possibility of the loss of heavy water through high-pressure leaks, it was decided that the GS process would be used to extract deuterium oxide from natural water and concentrate it to 15 to 20%. Vacuum distillation (the DW process used at Du Pont’s wartime plants) would further concentrate the heavy water to 90% and a third process, batch electrolysis, would bring it to reactor-grade purity of 99.75%. Morris et al. point out that the bulk of the separative work and costs of the heavy water production processes emanated from establishing and operating the GS process, which had never been attempted on an industrial scale. The other two processes were well known and had been demonstrated before their use at Dana and SRP.¹²

The first startup of a Dana GS unit in the winter of 1951–1952 was unsuccessful. The cold Indiana weather caused the hydrogen sulfide and water to form a solid hydrate, collapsing the interior trays. Moreover, some of the slotted bubble caps on the trays were broken because they had not been annealed. The corrosive power of the hydrogen sulfide gas also became “painfully evident” when internal roller bearings shattered on both the gas blower, which circulated gas through the towers, and its spare. The cause was hydrogen-sulfide stress-corrosion cracking. A great deal of research would be dedicated to learning about the effect of the gas on metal and the stress the process placed on it. Accordingly, changes were made in procedures and equipment to correct these challenges. By August, the lessons learned in the earlier attempt paid off, as the first of Dana’s GS units went into operation.¹³

The experiences at Dana were compelling. Experimental data, coupled with operations information, led to research on construction materials and methods that could be applied to the programs at Dana and its future sister plant at Savannah River. The corrosive power of the hydrogen-sulfide gas made this research and development program critical. Carbon steel was used for process vessels and for heat exchanger shells and piping. Tests were performed to find defects before use. The bubble-cap trays in the exchange towers were stainless steel. Carbon steel, "low alloy" steel, and stainless steel had to be heat treated to relieve stresses that were imbedded during fabrication. Bolts posed a special problem. If exposed to a hydrogen-sulfide leak, the bolt can absorb hydrogen. If it is stressed beyond a certain threshold, it will crack. To avoid this, all bolts were heat treated and installed to a predetermined stress level with torque wrenches. Metal parts in which stress or hardness was necessary were designed in isolation from the gas. Maintenance procedures were devised and minimum thickness holes, 1/8-inch in diameter, partially drilled through a pipe from the outside, were used to better gauge the effects of corrosion and give early warning of problems.¹⁴

SAVANNAH RIVER JOINS DANA

When Dana was under development, the AEC had planned on two heavy water production reactors at the new production site chosen on the Savannah River. Du Pont forecasted that 300 tons of heavy water were needed for the two reactors. The six GS units at Dana had a design capacity of 240 tons per year, thus sufficient heavy water could be produced to put the two reactors into operation as they were completed. Three factors changed this forecast. First, the AEC added three more reactors to the new plant's construction. Second, a Du Pont study raised the heavy water needs per reactor from the original estimate 150 tons per reactor to 200 tons and finally, the estimated output of each heavy water unit of 40 tons could actually range from 30 to 40 tons.¹⁵ The requirements for heavy water changed accordingly. The AEC approved construction of six more dual-temperature units but at Savannah River. While the later plant would outlast Dana, the Indiana plant had earned its place in history. Both plants were in operation in 1951 with Dana first in operation that year.

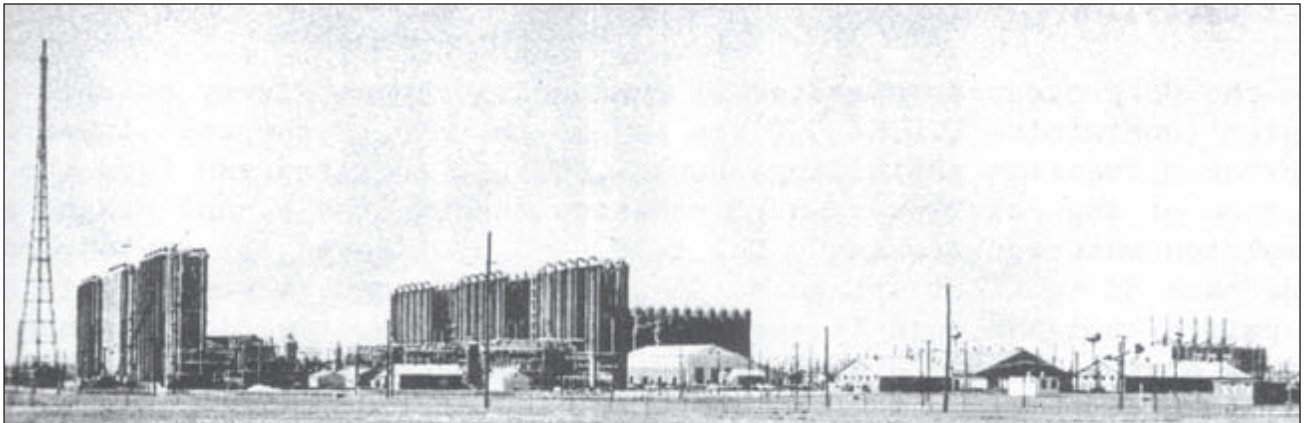

FIGURE 1 - GENERAL VIEW OF THE DANA PLANT

Prominent features are, from left to right: flare tower, south row of three GS units, control buildings, north row of three GS units, DW towers, service buildings, power house.

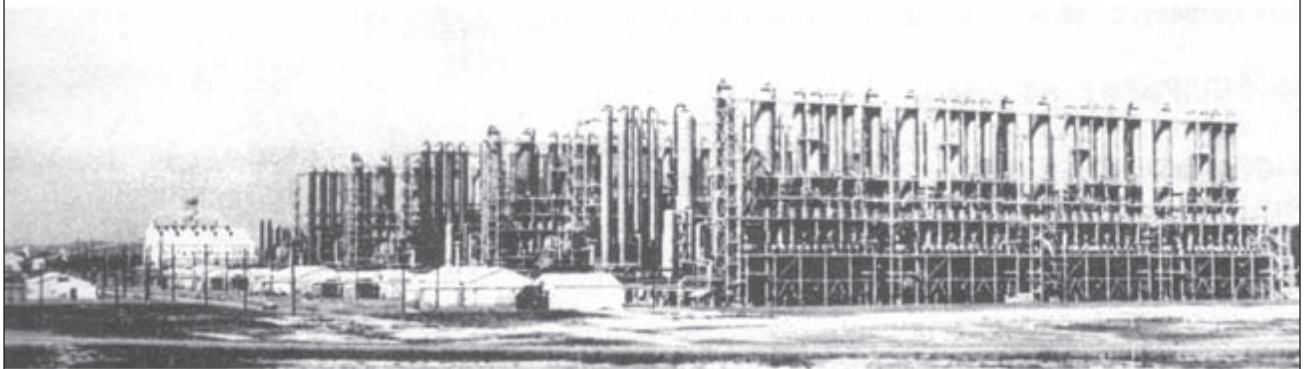

FIGURE 2 - GENERAL VIEW OF THE SAVANNAH RIVER HEAVY WATER PLANT

Prominent features are, from left to right: flare tower, power house, DW towers (in distance) GS control buildings, six rows of four GS units.

Dana Plant and D Area Compared, 1955. Source: E.I. du Pont de Nemours & Co, Savannah River Laboratory, Production of Heavy Water Savannah River and Dana Plants Technical Manual, July 1959, DP-400, 17.

V. 400/D CONSTRUCTION

Construction had commenced at the production site in South Carolina but was barely underway when the decision to expand heavy water production facilities was made. A. J. McCullin, a civil engineer with Du Pont, kept a work diary that indicates on December 20, 1950, the force on the ground was told “that it would be some time before a decision would be made about locating a heavy water plant on the Savannah River Site.”¹ The hiatus was shortlived. By January 9, 1951, McCullin and others involved with the site’s acquisition were advised that the heavy water plant was needed and that obtaining the required land within the proposed overall site boundaries for the heavy water facility had become a top priority. The site chosen was just south of the town of Ellenton and was roughly contained within a one-square mile tract. Twenty days later, a tentative layout for the 400/D Area was created and in February Du Pont began consultation with the Charleston & W.C. Railroad to begin the permitting process to build a road across the tracks that would lead to the new production site.

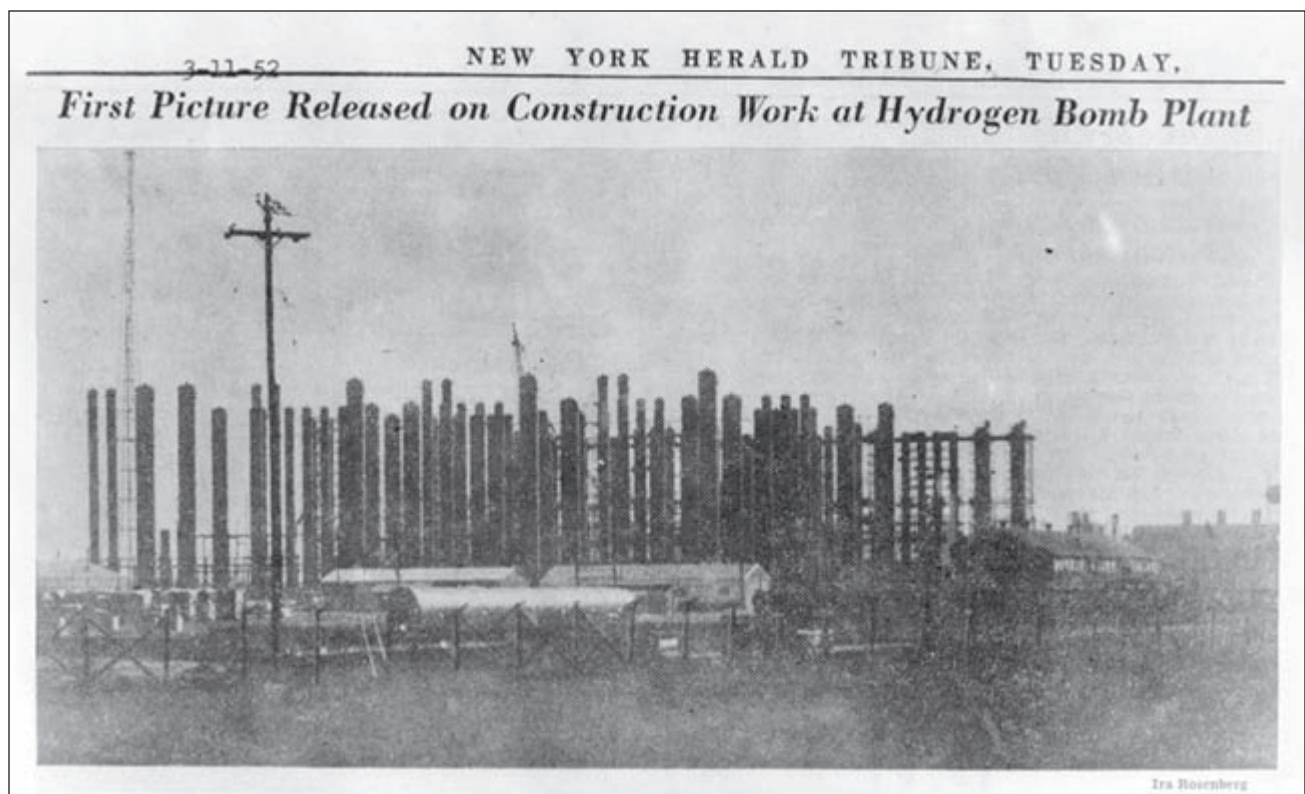

This photograph, taken during D Area’s construction, made news as the first picture of the top secret hydrogen bomb plant in the New York Herald on March 11, 1952. Courtesy of SRS Archives, negative 653-1.

Although the decision to construct the 400/D Area came early, the geography of the future reactor areas and separation areas had already been selected based on safety and strategic principles. To Du Pont, the remaining areas were not really suitable for facilities that would use toxic gas. However, the need for heavy water was imperative so site criteria were developed. Five factors were involved in the choosing of the site’s central location near the western plant boundary, the Savannah River.² The site was considered to be located at a “satisfactory” distance from the 100 areas, the destination for the heavy water. Its location one mile south of Ellenton was

desirable as Ellenton's inclusion in the plant boundary was still under discussion. Wind patterns played a role – a prevailing westerly wind offered some protection to an unnamed community that was located one mile west of the proposed site, most likely in Georgia. Proximity to the Savannah River and to existing railroad lines were also factors and finally the site contained room for 100 percent expansion of its facilities. The latter was a constant parameter in Du Pont planning.

VWF&S were responsible for the area layout and McCullin's diary suggests that there were two layouts under consideration. Du Pont's Engineering and Design History explains the key challenge in laying out the 400/D Area facilities:

Prevailing winds and the presence of large quantities of a toxic gas (H_2S) played a more important part in determining the layout within the #400-D Area than in the choosing of the site for that area. Processes utilizing H_2S are located downwind from the service and administration buildings. In addition, separation of the hazardous (with respect to H_2S) from the non-hazardous buildings is effected to an extent which results in the plant layout covering more area than would be expected for normal Du Pont commercial work.³

The author cited distances of up to .5 miles for distances between the main GS facility (tower units) and some proposed service buildings as well as the powerhouse. But some support facilities would be placed in locations more convenient to the process buildings for efficiency. The layout crews that arrived to begin the area's transformation found the fairly level site covered with a light growth of pine and scrub oak trees with dense underbrush in some areas. Grading began on May 15, 1951. R. B. Potashnick and Company performed the work which would remove approximately 280,000 cubic yards of earth over a two-month period.⁴

Du Pont responded to this critical change in scope by hiring the Lummus Company to design the SRP heavy water facilities. They shortened the Lummus Company's learning curve by hiring the Girdler Company as SRP consultants. Lummis, an architecture and engineering firm that specialized in the petroleum refining and chemical fields, was headquartered in New York City.⁵ The firm had previous AEC experience as well as experience with Du Pont. Lummus was responsible for the process buildings in D Area including the GS Units, the hydrogen sulfide plant, tank farm, flare tower, the DW (distillation) Plant, and E (electrolytic) Plant as well as a number of support buildings associated with the GS Units. Voorhees Walker Foley & Smith, also a New York firm, would handle the service building design.

Construction began on April 2, 1951 and the area was handed over to the Miscellaneous Area Construction in May of 1953 to do finish work. Highlights of the construction are included below in Table 4. The "Final" acceptance of all 400/D area facilities would occur in October of 1955. The first GS tower unit of 411-D went up on May 10, 1951 and the last unit of 413-D was erected by December 15, 1952. Their sequential construction took over two years. The powerhouse, the largest to be built at the new plant, was accepted by operations after its completion on April 27, 1953; its construction took 22 months. The buildup of the workforce was slow initially as members of the critical crafts preferred to stick to jobs in which longer hours resulted in a higher pay rate.

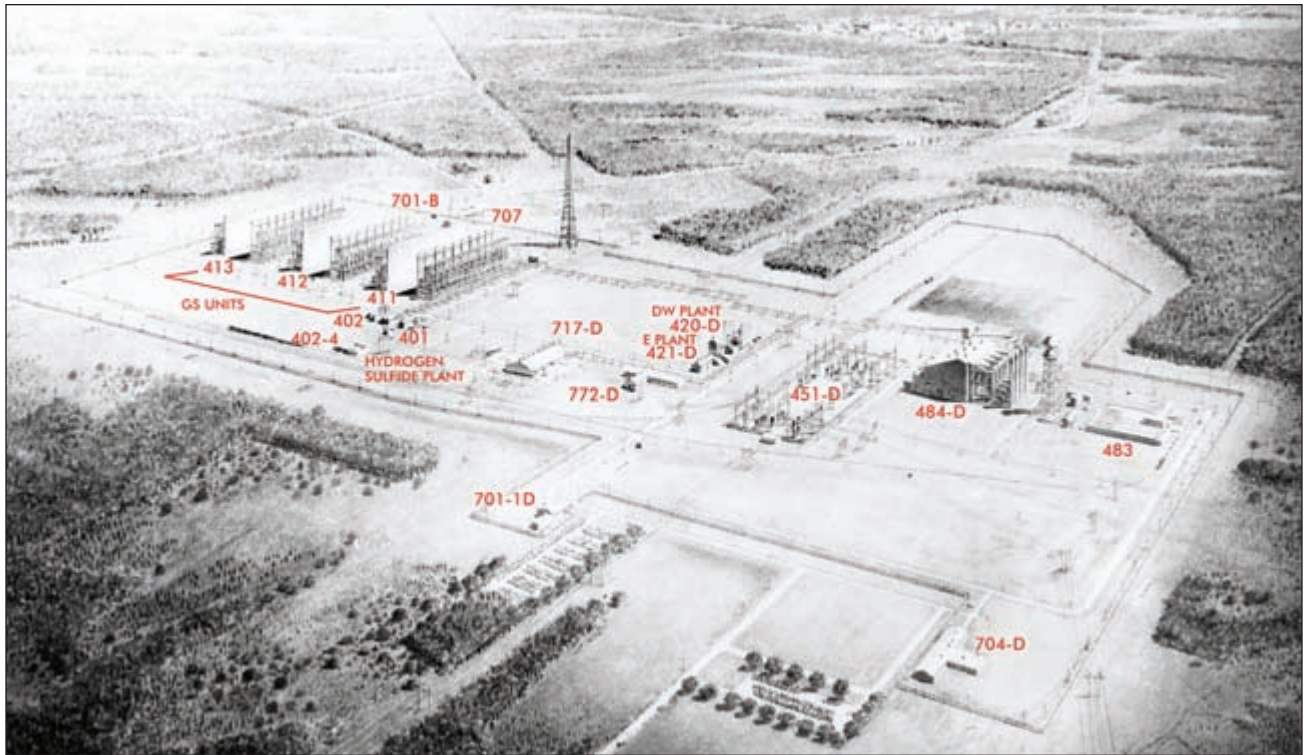

Bird's eye view drawing of the 400 Area created by Voorhees, Walker, Foley & Smith in 1953. Building numbers added to original. The architectural rendering shows the GS Units and flare tower located at the eastern end of the building area. The hydrogen sulfide plant was located by the GS units while the DW and E processes were housed in buildings 420-D and 421-D. The massive powerhouse, substation, and ancillary facilities were grouped at the western end with the laboratory, rework and storage facilities, and shop in the center. Savannah River 400 Area, No. 14, Env. 14. Courtesy of the Hagley Museum and Library.



Power House after Completion. Courtesy of SRS Archives, Negative No. 3142-004.

This changed in 1952 when the construction was at full tilt and workers went on a 54-hour workweek. A peak of 9,252 workers was reached by August 9, 1952. By November, the critical facilities had been built and were in operation. Less complex support and service facilities soon followed.

Table 4. 400/D Area Construction Highlights

| YEAR | DATE | MILESTONE |
|--|--------------|--|
| 1951 | April 2 | Site work and general grading begins |
| | April 24 | Construction begins on first permanent structure, 411-D, Production Unit No. 1. |
| | June 15 | Construction begins on 412-D, Production Unit No. 2. |
| | June 19 | Construction begins on 484-D, Powerhouse. |
| | July 3 | Construction started on 413-D, Production Unit. |
| | July 20 | Railroad in area ready for use |
| | September 6 | The first process tower received. |
| | September 27 | The first process tower erected using gin-poles. |
| | October 29 | The first tower erected by the stiff -leg derrick. |
| | December 27 | Fifty-one towers are erected by this date. |
| 1952 | January 26 | Flare stack tower completed. |
| | March 3 | First start-up meeting held for area. |
| | April 14 | 400/D Area given priority on labor, materials, and essential facilities to meet construction schedule. |
| | June 24 | Water Filtration and Treatment Plant starts up. |
| | June 25 | A gas evacuation drill for all employees in Buildings 411-D, 412-D, and 413-D held. |
| | July 1 | Boiler No. 1 in Powerhouse start up |
| | August 9 | Peak work force of 9,251 reached |
| | August 15 | Hydrogen-sulfide plant and tank farm signed over to Operations |
| | October 6 | Area patrolmen assigned |
| | October 28 | Concentrator Building accepted by Operations |
| | November 10 | The last tower was received and erected on November 13 |
| | December 23 | Final acceptance of Building 411-D, the first of the GS units, occurred |
| 1953 | March 10 | Final acceptance of Building 412-D |
| | April 27 | Final acceptance of Powerhouse |
| | April 28 | Manual switchboard on the area was discontinued |
| | May 13 | All construction work taken over by Area Construction organization |
| Source:NF Construction History, 154-155. | | |

Factors affecting schedule included the transfer of information on process design from the operations at Dana that resulted in design improvements but also the schedule. In addition, nation-wide shortages of essential materials such as stainless steel pipes and tubing, valves and materials for heat exchangers also played a role. Procurement issues with the GS towers were numerous. To expedite the work and to handle the magnitude of what was needed, ten vendors around the country were selected. Their size, materials, and the large number of vendors involved

JUNE 26, 1952

\$6.00 A YEAR

ENGINEERING NEWS-RECORD

SEVENTY-EIGHTH YEAR OF PUBLICATION

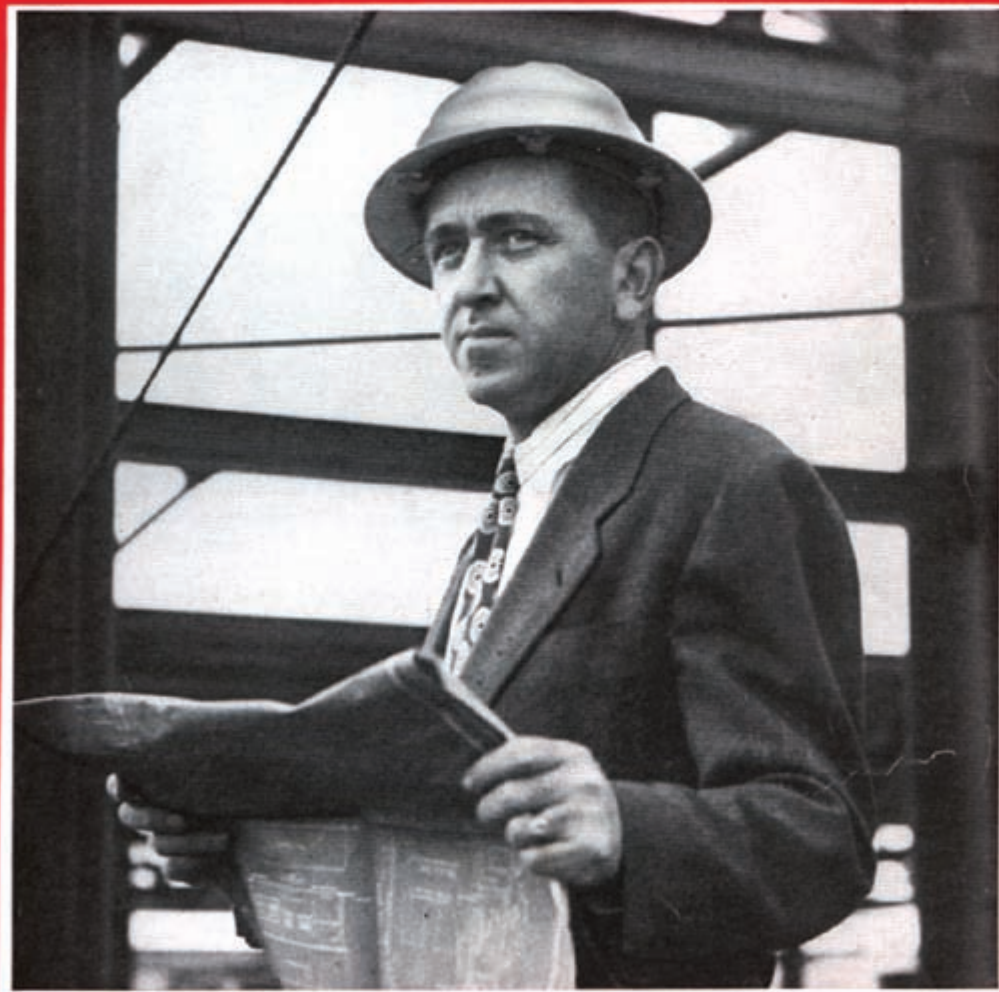

Field Project Manager Robert K. Mason supervises a 200,000-acre, 30,000-man H-bomb project. (See p. 36)

- ★ GM BUILDS NEW DUAL-FUNCTION PLANT
- ★ COMPOSTING FOR PROFIT

Bob Mason, head of construction would be interviewed by Engineering News Record on how SRP's construction was managed given its schedule and size. In his and Du Pont's words: PLAN YOUR WORK. WORK YOUR PLAN.

made a substantial headache for the men in charge of schedule as delays piled up. Valve availability was also problematic as the plants charged with producing the stainless steel trim, motor-operated, isolation valves for the GS units were involved with labor strikes. In some cases, temporary parts were used to move ahead with construction, leaving a place for the delayed valve to be later inserted. Shortages in heat exchangers, flowmeters, filters, separators, precast slabs, and bubble trays were very much a part of the delay in 413-D, the last GS unit to be assembled.⁶

In addition to procurement issues, there were unique construction challenges posed particularly by the towers. The towers were approximately 125' in height, and ranged in size and weight from 12' in diameter, weighing 175 tons to 6'6" in diameter and 65 tons. Just getting them to the 400/D area site required planning and special



Use of the stiff legged derek, a 200-ton machine, enabled the D Area construction force to lift the immense GS towers from the railcar and set them on the concrete pedestals with speed and precision.

VIEWS: 1. Main View: Courtesy of SRS Archives, negative M-477-009; 2. Derrick was assembled by the Savannah River where it presumably arrived by barge; 3. Workers begin the assembly process; 4. Riggers at work.

equipment. Heavy-duty railroad cars owned and managed by the American Association of Railroads were drafted, to transport the towers to the site from the individual vendor's location. Each tower was carried by two heavy-duty railroad flat cars specially fitted for the operation with a spacer car between them. Three idlers were assigned to each transport and special routings were chosen to eliminate curves, tunnels, or narrow clearances. As a limited number of these cars were available, scheduling was a critical issue.⁷

Once the towers arrived, they posed other challenges. The load-bearing capacity of the soil in the 400/D Area due to its location near the river was insufficient for concrete footings for the heavy towers. Engineers solved this problem by using hollow concrete pedestals or pontoons to support the towers. Thus the weight of the tower, once placed on the pedestal, would be equal to the soil that had been removed.⁸

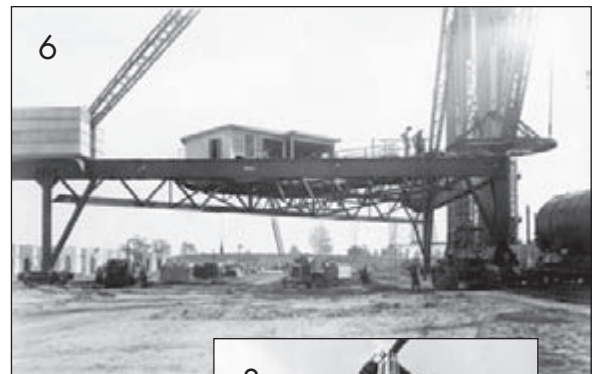

VIEWS: 5. Crane cab; 6. Detail of lower part of Derek showing operator's building; 7. Detail of equipment; 8. View upward; 9. Close up of operator's building; 10. View from operator's perspective.

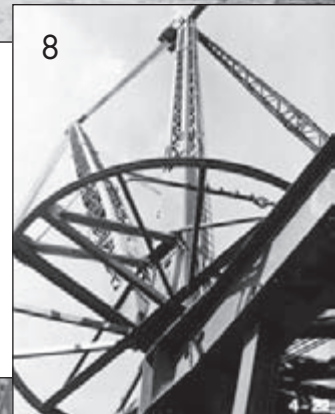

TOWER CONSTRUCTION THE STIFF-LEGGED DERRICK AT WORK



TOWER CONSTRUCTION VIEWS: 1. Building Sign; 2. Constructing a reinforced concrete foundation for tower platforms; 3. Construction of concrete pedestals for tower units; 4. GS Unit area showing pedestals in various stages of completion, train in forefront; 5. Stiff legged derek lifting first tower; 6. Derek completing tower row; 7. Tower being elevated; 8. Tower in place; 9. Units in place.

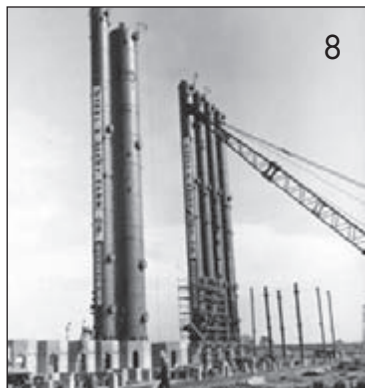
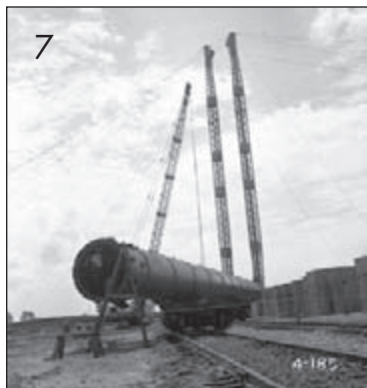

The next challenge was setting the specially fabricated towers onto their aligned pedestals. Gin poles and crawler cranes had been used to erect Dana's ninety-six 128-foot-high towers. Like their Savannah River counterparts, Dana's construction force worked faster as the construction of the towers proceeded. The Dana construction history notes that the first tower took five hours while later towers were placed on their foundations in 30 minutes. Gin poles could not be used at Savannah River as the order that the towers were delivered did not match their desired spatial order.

This scheduling challenge led to the use of the 200-ton stiff-legged derrick. Typically used at shipyards, the derrick's performance in erecting the large towers was a showstopper. The derrick, placed on parallel railroad tracks laid along the ends of and between the legs of the tower, would lift a tower from a car and set it on its foundation. Typically, a six-man rigging crew could erect one to five towers a day. Bebbington states that a tower was erected in six minutes in one demonstration.⁹ It was so successful that the erection of the GS units was completed in almost assembly-line style, allowing early operation of each unit as soon as it was completed and the prefabricated piping made in Central Shops was attached. Heralded as a timesaving device, the derrick, created by the vendor, was featured in *Engineering News Record* and in equipment magazines. One hundred and forty one small and large towers were erected with the crane at SRP.

AREA LAYOUT AND MAJOR FACILITIES

Roughly rectangular in shape, 400/D Area contained about 159 acres within its perimeter fence line. The actual building area, which was far smaller, was organized in large blocks. As noted, the use and presence of a toxic gas helped define the area layout. The GS units at Savannah River were known as Buildings 411-D, 412-D, and 413-D. The GS units were located in a large block at the eastern edge of the 400/D Area. A control house,

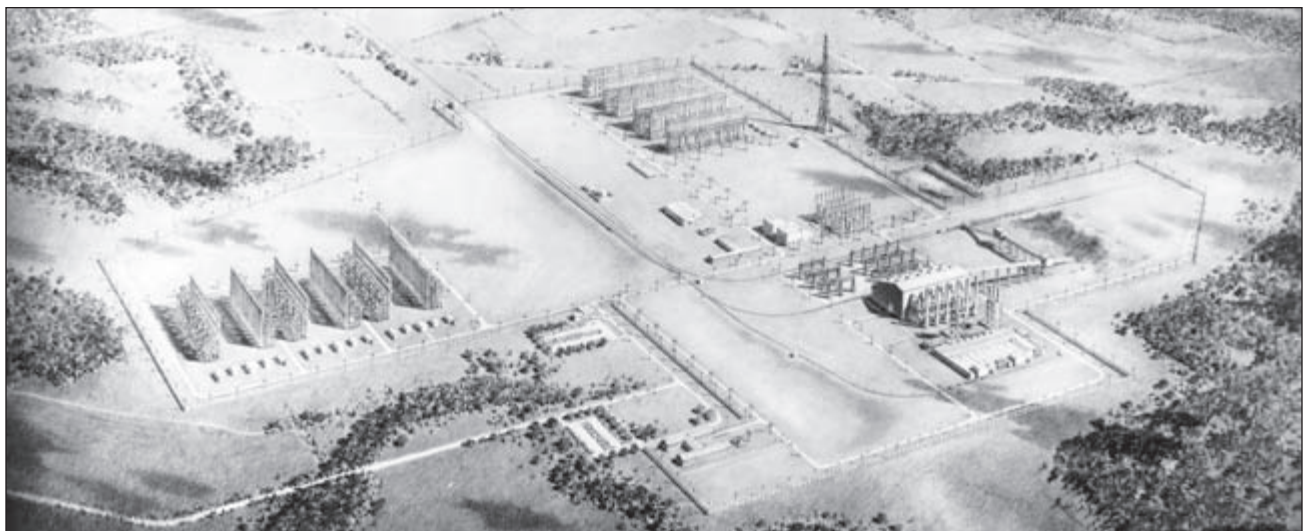

The 400/D Area's layout was defined by safety concerns. This bird's eye view shows that two GS Tower unit layouts were under consideration when the area was designed; one in the center left considered for future expansion and the GS units that were constructed, the grouping in the upper right. The GS tower units were located downwind from the service and administration buildings (in the foreground) to address a key safety challenge involved with a process that used H₂S. The view also shows clearly a break in Dupont's design philosophy for commercial layouts predicated on the need to isolate the support buildings from the process zone as much as possible.

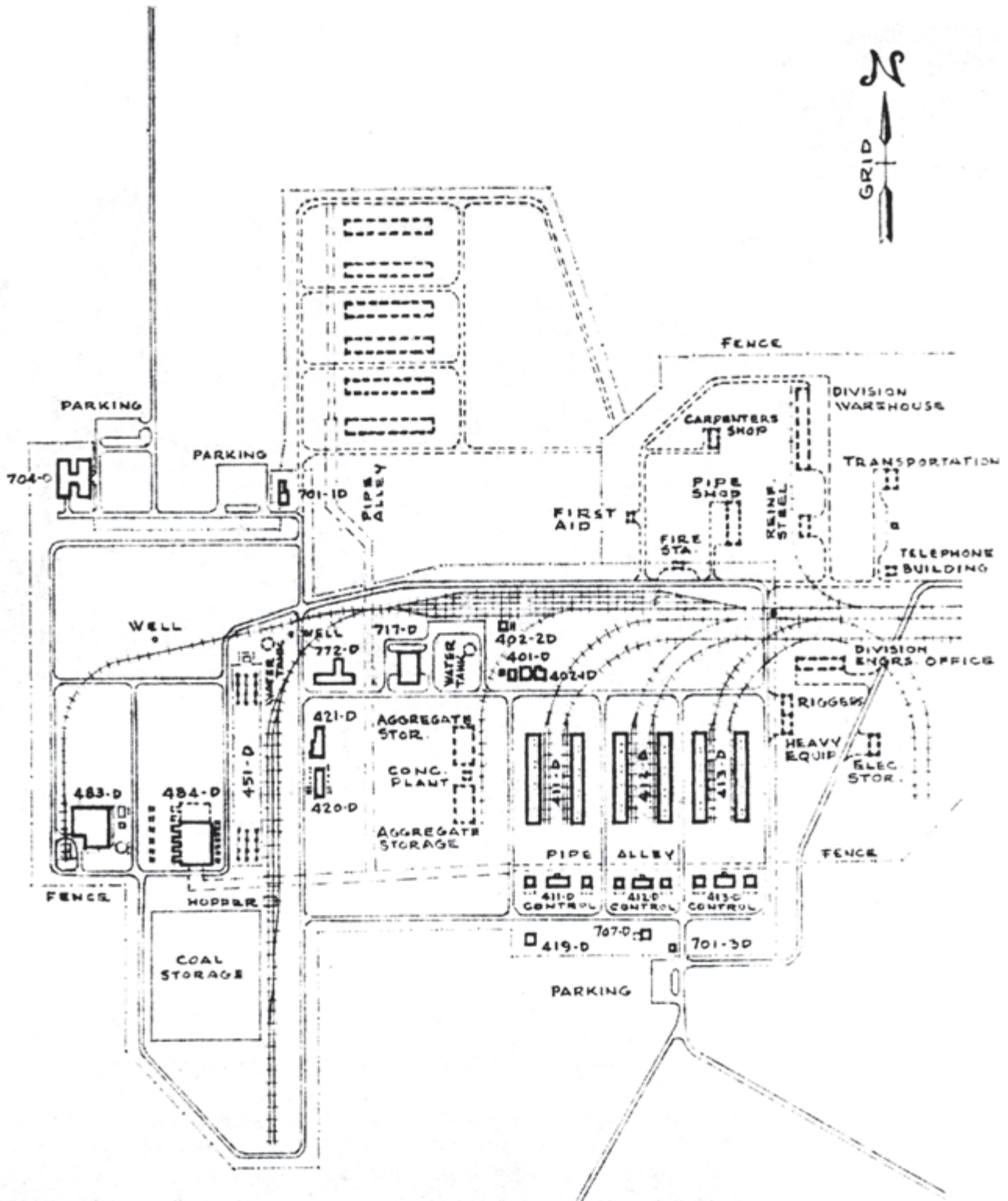

Construction-era Map. This map contains a wealth of information about the construction era and the temporary buildings and railways that were used in the construction of the 400/D Area: concrete plants, storage and temporary buildings are depicted.

substations, breathing stations, maintenance shelter, and an analyzer house complete the facility. These small support buildings were placed directly south of them. The flare tower (419-D) was positioned at the south edge of the process area. The 375 feet high steel flare tower, constructed to burn emergency discharges and routine leakage of H_2S , was situated south of the GS units. Otherwise open space surrounds the tower area. Presumably, this open area was earmarked for expansion if it was needed.

While the distinctive GS units and flare tower which could be seen from outside the site boundaries were the visual image that most area residents connected with SRP, other facilities were present. A concentrator for the distillation process (420-D), the second step in the heavy water production process was built with twelve distillation towers and support buildings. The towers ranged in height from 78 to 92 feet in height and between 4 and 6 feet in diameter. The finishing of the heavy water took place in 421-D, a multi-level steel frame building that housed the electrolytic process equipment. The electrolytic process further increased the concentration of plant's heavy water output. Two cylinder-loading buildings were involved in the final finishing and storage of the heavy water. These facilities along with an analytical laboratory and other support buildings were situated in the central block of the area layout between the GS units and the infrastructure-related facilities to the southwest.

A river pumphouse supplied water to 400 Area while steam and electricity was furnished by the plant's powerhouse, 484-D. At the time of its construction this was the largest powerhouse constructed by Du Pont. It was outfitted with a coal-handling system that could handle 350 tons per hour. A cooling tower, primary substation and transformer yard and coal storage area were located near the powerhouse. Finally, the Supervisor's Office and First Aid Building (704-D) and area gatehouse (701-1D) were located at the northwestern edge of the 400/D Area.

When compared with other process area layouts, the 400/D area layout was the least integrated of the building areas at SRP. Other process areas featured more compact, space-efficient plans with a closer association of the process buildings to their support buildings. This contrast is likely attributable to the safety needs inherent in the use of hydrogen sulfide that predated spatial buffers and serious attention to wind patterns as well as the speed at which the 400/D area was conceived and sited.

BUILDING DESCRIPTIONS

The following buildings and facilities were constructed in the 400/D area (Table 2). Due to the urgent need for heavy water, many of the process facilities were "partially accepted" by Operations personnel when the essential construction and equipment installment was complete so that the facility could immediately be put into operation (see below). Final acceptance usually occurred within four to six months when the facility was truly completed and Final Full acceptance came later. Although Table 2 presents all facilities constructed in the 400/D Area, this study focuses upon those facilities that were directly associated with heavy water production. Facilities associated with power production and safety are documented fully in separate thematic studies. This section provides building descriptions of the heavy water facilities as built along with their design history. Historical sources are needed as many of the facilities were decommissioned, resulting in demolition or removal prior to the architectural inventory of the Site in 1998. Two sources, both produced by the Engineering Department of Du Pont, were drawn upon

heavily to compile these descriptions: the Engineering and Design History, Volume 5 (1957) that focuses on the 400/D Area and the Construction History (1957).

Table 5. Facilities and Buildings Constructed in 400/D Area, 1951-1953.

| Building No. | Name | Work Started | Partial Acceptance | Final Acceptance |
|----------------|--|--------------|--------------------|------------------|
| 401-D | Hydrogen Sulfide Plant | 8/6/51 | 8/15/52 | 12/26/52 |
| 402-D | Tank Farm | 8/6/51 | 8/16/52 | 12/26/52 |
| 411-D | GS Unit | 4/24/51 | 9/27/52 | 12/23/52 |
| 412-D | GS Unit | 6/16/51 | 12/14/52 | 3/10/53 |
| 413-D | GS Unit | 7/3/51 | 2/20/53 | 5/7/53 |
| 419-D | Flare Tower | 8/15/51 | | 10/16/52 |
| 420-D | Concentrator | 7/16/51 | 9/25/52 | 10/28/52 |
| 421-D | Finishing Plant | 7/18/51 | 10/28/52 | 11/25/52 |
| 421-1D | "E" Process Cylinder Loading | 4/1/53 | 7/13/53 | 9/16/53 |
| 421-2D | Cylinder Loading | 3/4/54 | 6/7/54 | 10/4/54 |
| 451-D | Primary Substation | 7/18/51 | | 4/1/53 |
| 452-D | Secondary Substations | 4/2/52 | | 1/22/53 |
| 480-1D | Chemical Feed Building | 4/19/52 | | 5/26/53 |
| 480-2D | Chemical Feed Building | 6/2/52 | | 5/26/53 |
| 480-3D | Chemical Feed Building | 6/14/52 | | 1/29/53 |
| 483-D | Water Filtration and Treatment Plant | 7/5/51 | 9/15/52 | 7/2/53 |
| 484-D | Powerhouse | 6/19/51 | 9/10/52 | 4/27/53 |
| 485-D | Cooling Tower | 2/13/52 | 1/29/53 | 5/25/53 |
| 487-D | Elevated Water Storage | 8/28/51 | 9/15/52 | 5/25/53 |
| 488-D | Ash Disposal Building | 11/13/51 | | 10/16/52 |
| 701-1D | Area Gatehouse and Patrol Headquarters | 7/12/51 | | 11/11/52 |
| 701-2D | Gate House | 9/3/51 | | 9/24/52 |
| 701-3D | Gate House | 9/10/51 | | 9/24/52 |
| 704-D | Supervisor's Office and First Aid | 7/6/51 | | 12/17/52 |
| 707-D | Change House | 9/7/51 | 9/22/52 | 11/5/52 |
| 711-D | Steel and Pipe Storage | 1/7/52 | | 9/26/52 |
| 711-D addition | | 11/2/53 | | 2/5/54 |
| 717-D | Shops Stores and Change House | 8/7/51 | 10/17/52 | 11/18/52 |
| 772-D | Control Laboratory and Supervisor's Office | 8/7/51 | 9/22/52 | 2/20/53 |

Source: Engineering Department, E. I. Du Pont de Nemours, Savannah River Plant Engineering and Design History Volume V (1957), 19-269.

HYDROGEN SULFIDE PLANT (401-D)

Located to the west of the GS units, the hydrogen sulfide plant was adjoined by the tank farm. The purpose of this facility was twofold. It was built to produce an initial charge of about 750 tons of hydrogen sulfide for the GS units and to make up for any losses during operations. It could also liquefy gas that would be needed when the GS units were ready to be closed down. Second, the facility supplied the 400/D Area with inert gas needed for purging, blanketing, and testing equipment and to provide a supply of gas for dummy runs.¹⁰ It consisted of

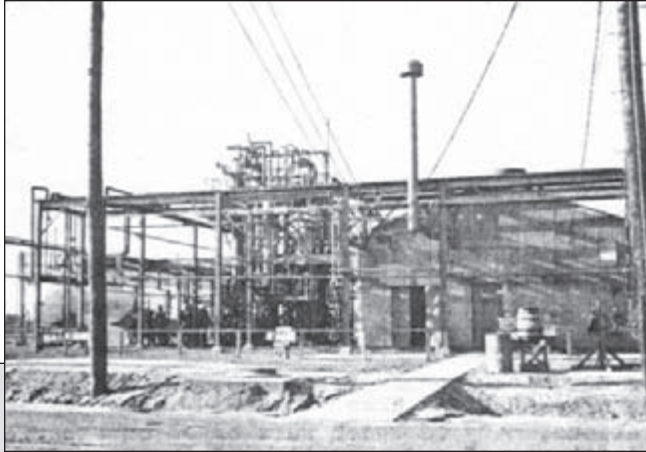

a compressor and control house, a shed, outside storage tanks, and towers. The plant's primary mission, the production of a toxic, flammable highly corrosive gas under high pressure, called for the design of mostly outdoor facilities.

Building 401-D, Hydrogen Sulfide Plant. Photograph after completion (left) and aerial view (below) circa 1952 showing extent of outdoor equipment. Courtesy of SRS Archives, negative M-889-012.



The compressor and control house (401-1D) was a 30' by 60' foot steel frame building placed with a gable corrugated asbestos roof on a reinforced concrete foundation. The compressor section was shielded by corrugated asbestos board walls; the facility had no windows. The control house included an electrical control room, instrument control room, supervisor's office and rest room facilities. An open shed, approximately 15' by 20', was placed on a concrete slab adjacent to the north side of the Control House for the storage of the inert gas generator. It also had a structural steel frame with corrugated asbestos roofing and was open on three sides. A wood frame, 7'

by 12' air breathing station with a corrugated asbestos roof and wall was on the southeast corner of the control house. One of six in the GS Area, the station was supplied with six air cylinders and hose racks.

The plant had an outdoor component involving a 41' steel superstructure mounted on a concrete slab to anchor the process towers that were involved in the manufacture of hydrogen sulfide. Precast concrete catwalks were used to access the equipment that was characterized as standard outdoor process equipment. This included a number of pumps to charge and unload the towers, storage tanks, a stripping tower (22" in diameter, 17' high), water wash tower (24" in diameter and 15' high), drums, separators, condensers, vaporizers and drain pots were used in the process. Some of the equipment was located at the adjacent tank farm but the primary pieces of the equipment were in the process area. The inert gas equipment was also assembled there featuring, storage tanks, generators and compressors. The piping used, given its mission, had to be designed for safety as well as economy. The piping was generally all stainless steel but lines carrying hydrogen sulfide or water mixed with hydrogen sulfide were built of pipe with greater wall thickness to reduce the potential for corrosion. Joints were welded and screwed joints were avoided as much as possible. In addition, wherever hydrate formation could occur, steam tracing was employed. Stress relieving and minimum thickness holes were also used to combat corrosion and other problems.

The control house had fairly standard equipment but it should be noted that the plant had its own communication and signal facilities that were also part of the area and site network in case evacuation was needed. Safety concerns in the design of the plant were paramount. Venting of equipment to the flare tower, area monitoring to identify and quantify any airborne contamination, the use of gas masks, the use of minimum thickness holes and sharp attention to process equipment materials were all noted. Finally, lessons learned from Dana were important to the safe operation of the hydrogen sulfide plant.



TANK FARM (402-D)

The Tank Farm was located west of the GS units, adjacent to the Hydrogen Sulfide Plant. It was a companion facility for the Hydrogen Sulfide Plant, providing for storage of the raw material and the finished product. Some of its equipment was part of the adjacent plant and some of the plant's equipment was placed in the Tank Farm area.



Building 402-D, Tank Farm. Views showing railroad-side facility (above) and "car spots" (opposite) after completion. Courtesy of SRS Archives, negatives 3142-2 and 402.



The facility sat on a raised concrete base with stairs and other vertical features composed of structural steel. It featured reinforced concrete dikes around the one vertical and seven horizontal tanks to ensure safety. One design issue was mentioned in the histories: car spots. When designed, the Tank Farm included two structural steel car platforms. The platforms and equipment were designed to accommodate cars with dome platforms. In the first year of operation, few cars with dome platforms were received, forcing SRP employees to walk the curved surface of the tank in order to make the proper pipe connections when other types of cars were involved. This hazard was removed within a year when the original car spot design was replaced with a design that accommodated all types of car platforms.

GS UNITS (411-D, 412-D, 413-D)

Heavy water production at Savannah River occurred through three separate process steps. The GS Units represented the first step in the concentration of deuterium oxide from natural water. Heavy water received from the Water Filtration and Treatment Building was concentrated in the three GS units where the concentration of deuterium oxide was increased from 0.015 percent by weight to 11 percent. After this concentration occurs, the product from the GS units was pumped to Building 420-D for further concentration. Originally called the Dual-Temperature process, the term GS was preferred for security purposes according to the Engineering and Design History. The Dual Temperature process is a better descriptor of what actually occurred in the large towers that housed the process that is based on the isotopic exchange between deuterium and hydrogen ions and it uses the deuterium exchange reaction between hydrogen sulfide and water to accomplish the needed concentration.

These mostly outdoor units are visually akin to refinery structures. They are identical facilities with the same components. All are located in the northeast corner of the 400/D Area. In addition to the vertical towers that dominate them, there were small support buildings at the base of each set including a control house, analyzer



GS UNITS

(Above) GS Units 411, 412 and 413. Views showing the three individual units after completion. Courtesy of SRS Archives, negatives 3063-6, 3064-9, and 3063-10.

(Left) Exterior View and Detail of Control Houses associated with each GS Unit. Courtesy of SRS Archives, negative 4207-6.

(Below) Exterior and Interior Views and Floor Plan of Control Houses associated with each GS Unit. Courtesy of SRS Archives, drawing W140230..

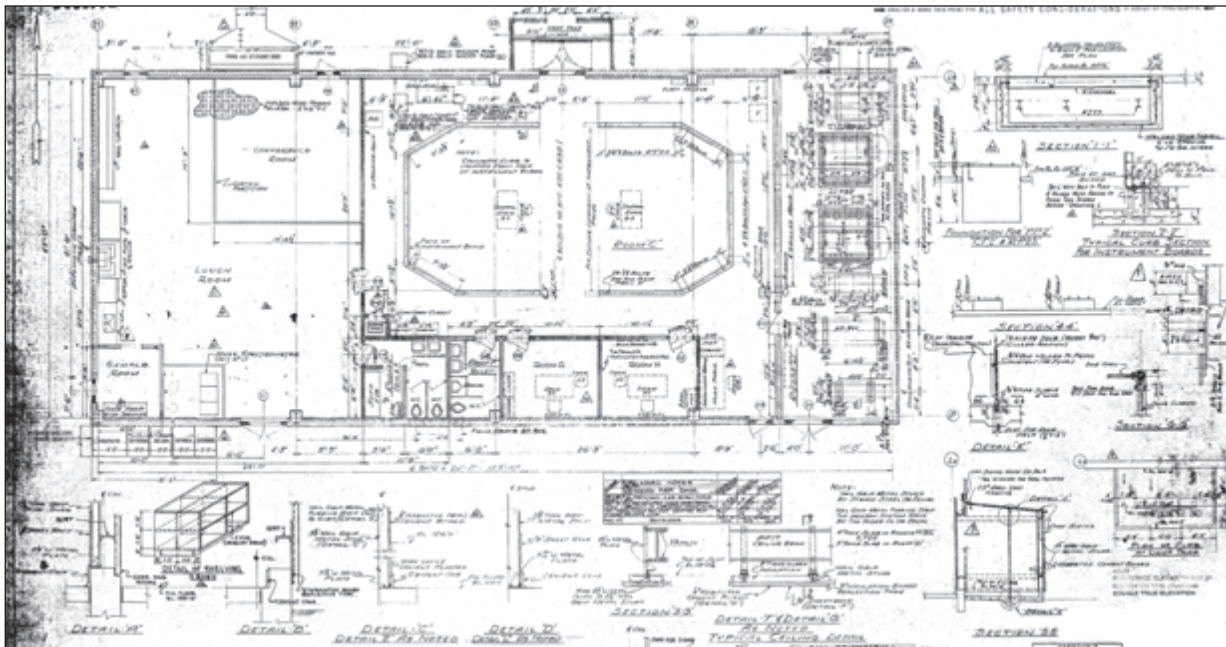

house, substations, breathing air stations and maintenance sheds. The sets of towers were described as “wings” each containing four GS units and their auxiliaries equipment.

Each unit had a control house with a central instrument control room, mass spectrometer room, a laboratory, offices, scale tank room, and rest room facilities. The control house was located on the east side of its respective tower row equidistant from each. The control house was a one story Class III building, about 47’ by 107’ in size, built on a reinforced concrete foundation. It was a rectangular gable roof building with a steel frame superstructure clad with concrete asbestos board. The interior partitions were made of sheetrock. The building type was windowless.

An analyzer house was also part of each GS unit. A small wood frame building also of Class III construction, it measured about 22’ by 16’ and contained 350 square feet. Corrugated asbestos siding and roofing covered the building that sat on a concrete slab. This facility housed the instruments used to analyze all the wastewater streams from the GS units and the Hydrogen Sulfide Plant for hydrogen sulfide.

Each unit had two electrical substations described as single story Class III buildings, 40’ by 30’ in size. They were located on either side of the unit control house. Rectangular with gable roofs, each had a steel frame, concrete foundation, corrugated asbestos roofing and exterior walls. A reinforced concrete vault, the same size as the building was excavated below grade. The breathing stations, described above, were present as well as an impermanent maintenance shelter.

The wing structures on which the towers were mounted were the heart of each unit. Each wing was on a large reinforced concrete mat, 62’ x 452’ x 14’ deep below grade. As discussed earlier the insufficient load bearing capacity of the soils at the GS unit site called for special foundation designs for the heavy towers it would support. Concrete slabs of varying thicknesses were laid down upon which hollow octagonal pedestals were placed, about 10 feet above grade, on the thickest slab to support the towers that were erected in a row.

An open-air steel frame structure with four levels (445’ by 39’ by 54’ high) sits on the mat with the towers, enclosing all the process equipment but the towers. The first floor contained pumps and blowers, the second had separator tanks and control stations, the third and fourth floors had heat exchangers. Steel stairs with concrete treads provided access to the equipment on these levels; a substantial stairwell lead from grade to the 54-foot level.

Each wing had four GS Units. Each unit had six 125’ high towers in which two stages of concentration occurred. The towers were described as “counterflow liquid and gas absorption vessels or stripping towers for the separation of gas and liquid.”¹¹ One hot tower (12’ diameter) and one cold tower (11’ diameter) comprised the first stage of concentration; the second took place in two hot and cold towers with 6’ wide diameters. The towers weighed between 65 and 175 tons each, were fabricated of carbon steel. Each stage group had its own auxiliary equipment that was placed on the steel superstructure described above. Towers with diameters of 12’, 11’, and some 6’6” examples were filled with 70 bubble cap trays. The remainder was filled with 84 trays. Hot towers were insulated with magnesia block while cold towers were insulated with foamglass insulation. One history reports



that there was 122 miles of steam tracing in the three GS units in its equipment, instruments, blower, pumps and process piping. Other indicators of the size of the job were the use of insulation particularly in 411-D; 47 miles of piping was covered by insulation and more was used to cover towers, tanks, drums and separators, etc.

412-D and 413-D displayed the same features with few differences. Each unit had two breathing stations. Neither had an analyzer house but the maintenance shed associated with each was more substantial than the example at 411-D. A second support building was found in association with 412-D, the Mask Maintenance Shelter. This was a single story, Class III building. The 15' by 24' wood frame building's walls and roof were covered by corrugated asbestos panels and the building had a concrete slab foundation. This facility was devoted to the storage, distribution and servicing of personnel masks for the area, an important function for this area. The chief difference between the three units is that 411-D was built as a temporary structure while 412 and 413 were considered permanent. Unlike 411-D, they were designed to manufacture heavy water beyond the initial requirement for heavy water needed to start up the reactors. 411-D's associated buildings etc. were designed as temporary buildings, "having the same designed life expectancy as the Dana Plant."¹²

FLARE TOWER (419-D)

The Flare Tower was located at the south end of the GS Unit area. Its purpose was to burn emergency discharge and routine leakage of hydrogen sulfide from the process units. Built of structural steel, this narrow 375' high tower, 50' square at grade and 6' square at its apex, was placed on a 62' square reinforced concrete foundation. The tower had three platforms: one at the apex, one at 288', and the third at 144'. There was also a fourth platform near the base to facilitate operations. There were two flares. One was a low-pressure six-inch pipe at 400 feet, the second was a high pressure flare.

The flare tower was erected by the Calvert Iron Works on a foundation built by Du Pont. The tower's construction was hampered by many factors including problems with the iron and unsuitable piecework, a shortage of iron workers and workers who were rated for high tower work. The Construction History states that much of the steel had to re-fabricated in the field or replaced by the vender.

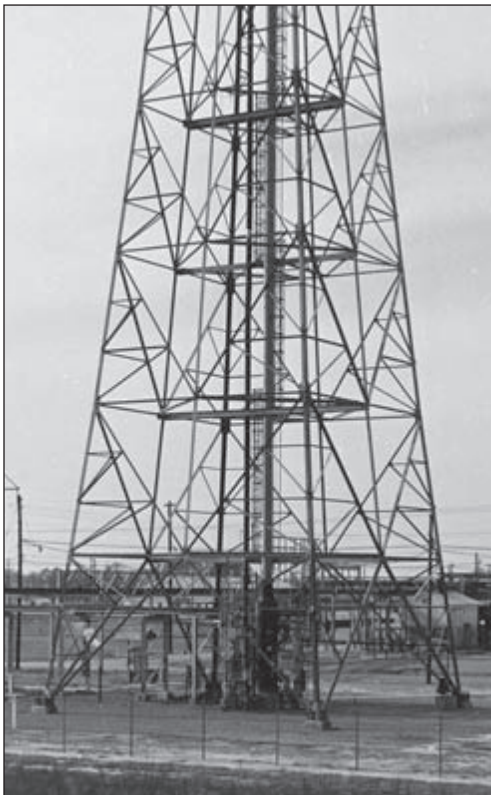
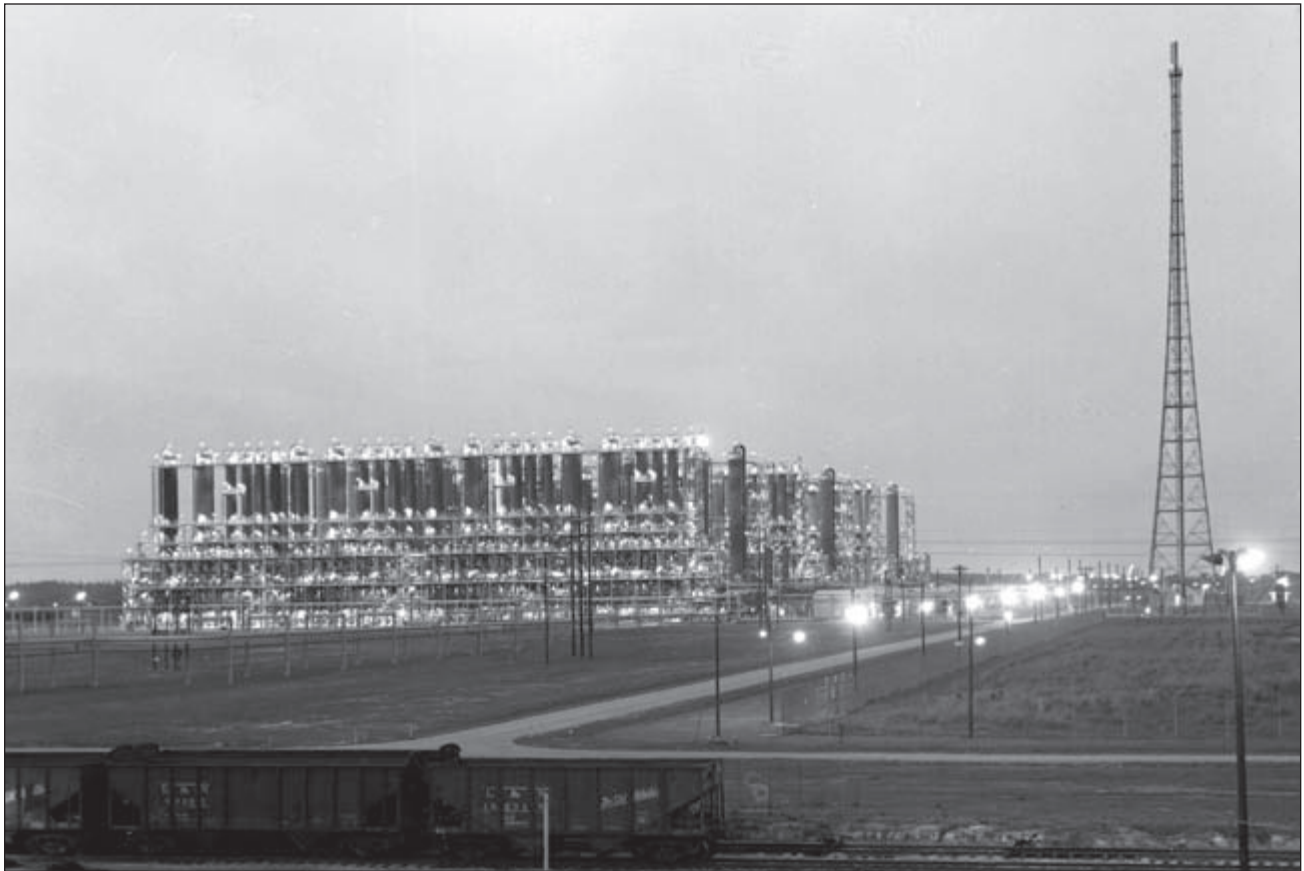

(This Page and Opposite) Structure 419-D, Flare Tower. Historic views of tower, tower top with flare in operation, and tower base, circa 1952. Courtesy of SRS Archives, negatives 3391-003 and 4207-4.

Safety was the primary purpose of the Flare Tower. Du Pont's engineers had learned from studies at Dana that routine leakage of hydrogen sulfide was better flared than recovered, and should there be an emergency release or high pressure discharge, rapid disposal through the flare was the objective.

By discharging at a high altitude, approximately 400 feet over grade, during normal atmospheric conditions, the gas becomes diluted to a non-toxic concentration by the time it settles to the ground. Under unusual and extreme conditions, such as a temperature inversion, dangerous concentrations may still be expected at ground level.

Hydrogen sulfide in very low concentrations evidences itself by its characteristic odor, that of rotten eggs. In higher concentrations it reacts on the olfactory nerves, deadening them completely so that one is not aware that he is in a toxic or perhaps a lethal atmosphere. However, hydrogen sulfide can be burned in air, producing sulphur

dioxide. While this gas is also very toxic and has a distinctive pungent odor, it does not deaden the sense of smell and, therefore, is noticeable in all concentrations. As a safety measure, an ignition system is provided at the top of the flare stack that makes it possible to burn the hydrogen sulfide discharge, converting it to sulphur dioxide. As with hydrogen sulfide, the sulphur dioxide should be adequately diluted by the time it reaches grade.¹³

While the Flare Tower would be one avenue for safety and would improve conditions should an incident occur, it could not contain the damage a major gas release could make. Thus Du Pont stressed that “all efforts to design against failure” on buildings and structures that contained or used hydrogen sulfide in their processes were made.

CONCENTRATOR (420-D)



The Concentrator facility housed the process equipment used in the second stage of heavy water production or DW Process at Savannah River. The product from the GS units, concentrated to 11 percent in the first stage, was received here, further concentrated to 98 percent by weight through the DW Process, and then sent to the Finishing Building.

Located in the south central block within the 400/D Area, the facility was a building with associated outdoor equipment. The Class III building was long and rectangular with a gable roof and a reinforced concrete foundation. The 35' by 160' building had a steel frame and was covered with corrugated asbestos siding and roofing material. The building was divided into an Instrument Control Room, pump room, electrical control room, and a compressor area. A mezzanine type superstructure supported condensers, coolers and jets.



Twelve distillation towers of varying sizes (78' high and 4' in diameter and 92' high and 6' in diameter) were located behind the building erected in two rows on octagonal concrete pedestals, 8-10 feet in height. These towers represented two vacuum distillation trains, each with five stages, during which the product is further enriched. After the fifth and final stage, the product now at 98 percent are withdrawn and pumped to a storage tank to be sent onward to the third step of the heavy water production process at Savannah River. The DW process was an established commercial process that had been used in Du Pont's earlier P-9 plants. 420-2D, a prefabricated metal building with a shed roof, was later added to the 420 facility to house the Rework Unit.

*Building 420-D, Concentrator. View showing towers and control building and view showing Concentrator towers. (Opposite) Plan showing general layout. Courtesy of SRS Archives, negatives *** and 4-412-5 and drawing S5-4-479.*

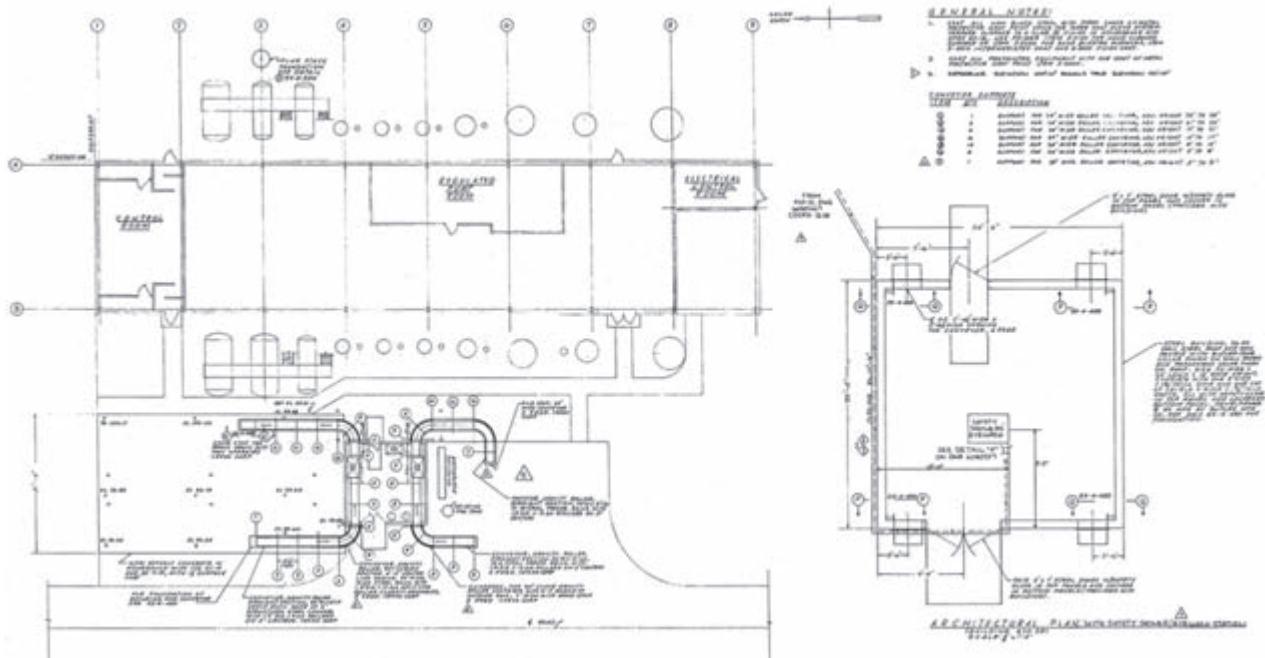

FINISHING BUILDING (421-D)

Heavy water received from the DW process begins its final enrichment in this building which houses the E Process. The idea was to increase the concentration of heavy water coming from the DW Process from 98 percent to 99.8 percent or better. Located in the center of the building area and adjacent to the Concentrator Building, this was a multi-level, Class III building with a structural steel frame covered with corrugated asbestos siding and roofing. The gable roof had multiple drum vents on its apex. The building overall was about 35' by 138'. Most of the building was single story, approximately 35' by 103.' This area contained the electrical control room and the electrolytic cell room. The remaining section was five stories in height and it housed the refrigeration unit and

its associated equipment. Two additions were made to the west side of the building; one addition measured 14' by 46' and the second was 25' by 20'.



Building 421-D, Finishing Building. Courtesy of SRS Archives, negative 4-357-2.

The process equipment included a scale tank, tanks, kettles, kettle condenser, mix tanks, electrolytic cells, condensers, gas burners, pumps, evaporators, feed tanks, and ammonium refrigeration units. Instrumentation, electrical equipment and piping were also part of the process. The first step was purification, followed by electrolysis within the 150 electrolytic cells that were installed. The product then went through a final purification

Building 421-D. View showing south elevation circa 1952. Elevations and five floor plans. Courtesy of SRS Archives, drawings W140307 and 140306.

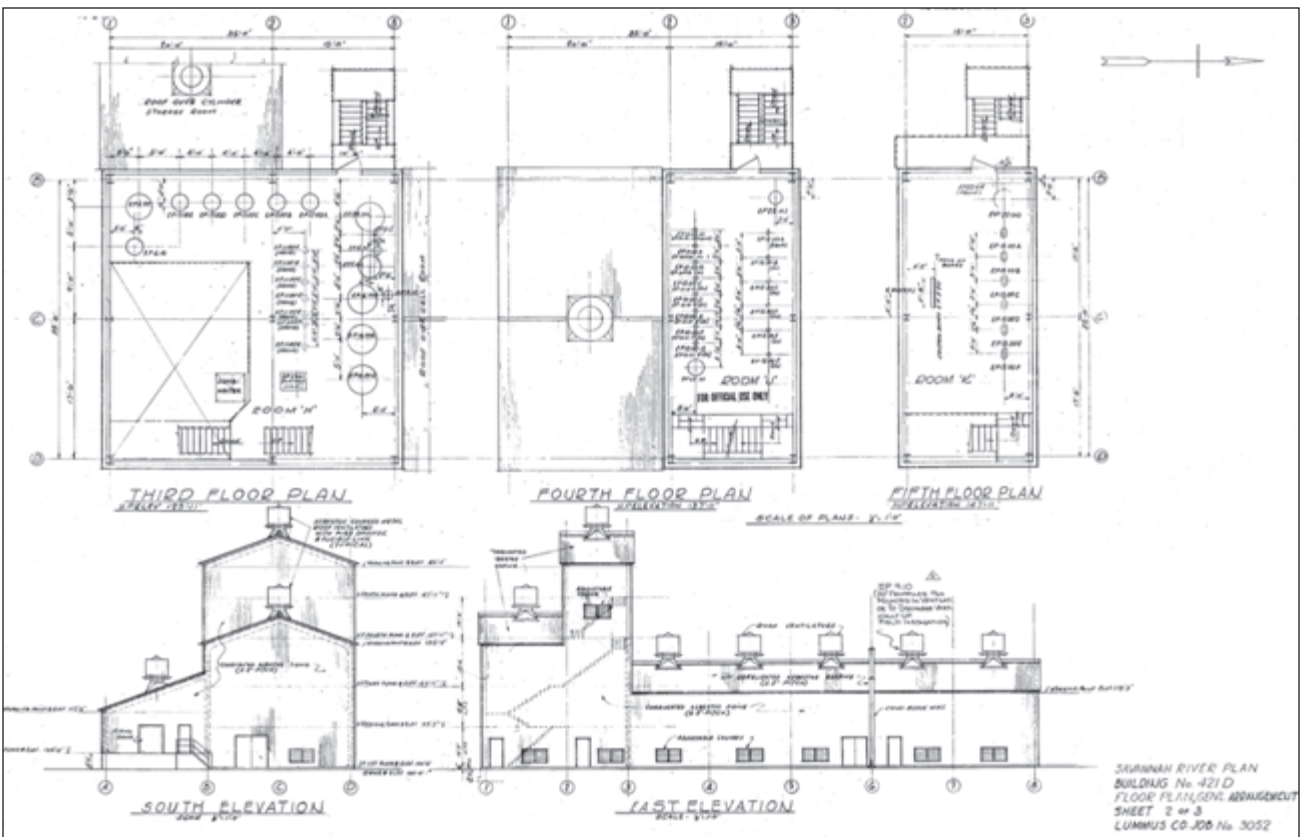
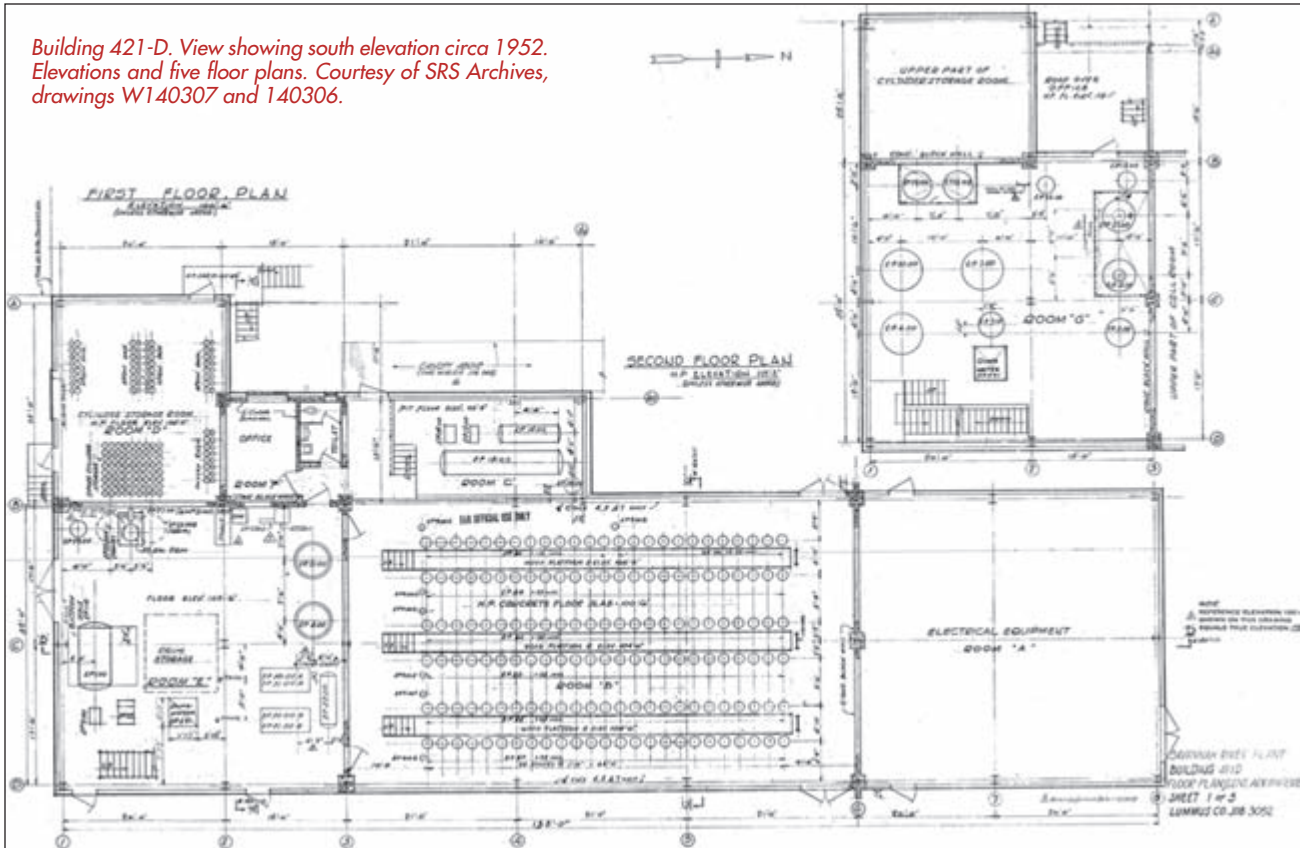

process. As a pure product was characterized by high resistivity to the flow of electricity, a conductivity cell was added as a check on the product purity. Drained by gravity, the product was placed in drums that were carefully washed, dried, and flushed with helium to remove light water vapor. The average production was 60 pounds per hour or an annual total of 240 tons. The drums were transferred for storage to 122-R.

CYLINDER LOADING (421-1D AND 421-2D)

This building housed the electrolysis of some heavy water from the E Process and the compression and storage of deuterium gas, produced during that electrolysis, into gas cylinders. The final product of this building had to meet the following requirements: nitrogen (less than 0.01 percent), oxygen (less that 0.01 percent), moisture (less than



(Above Left) View after completion, 1953. Above (Right and Below) Undated view of Entry Elevation and drawing showing all elevations and plan. Courtesy of SRS Archives, negative 2137-05 and drawing W161698.

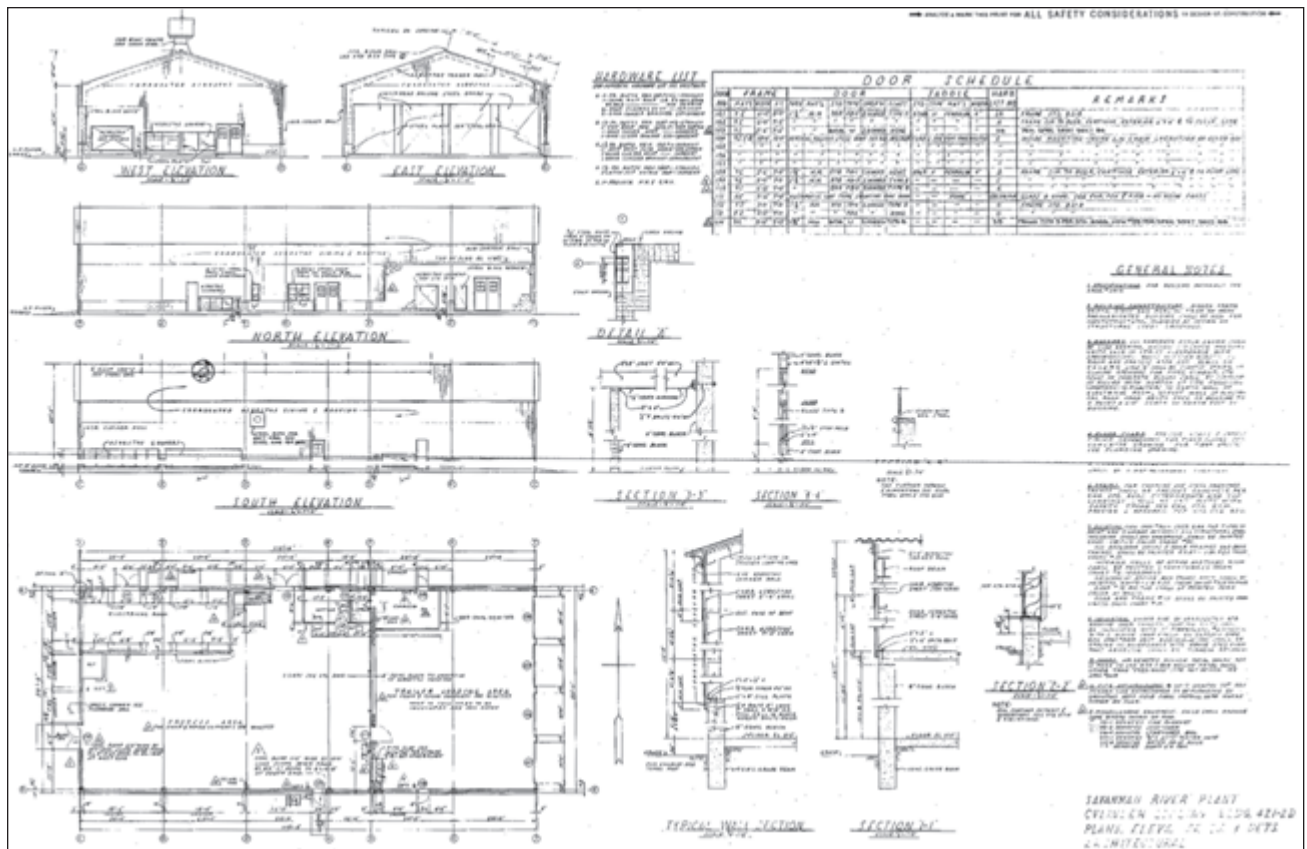

0.06 percent) and deuterium (minimum 99.5 percent). Du Pont's scope of work had outlined the specifications that called for a high degree of product purity. A second process aimed at recovery of deuterium from "off-quality" product was initially located in this building but was later moved to 421-2D in 1954.

A narrow building with two roof lines, 421-1D was also located in the center of the building area west of 421-D to which it was connected by a covered walkway. It was a Class III construction with a reinforced concrete foundation, a structural steel frame covered by corrugated asbestos. It had a shed roof with a band of louvered vents under the highest roofline. A circular gas holder was stationed outside the building was mounted on a concrete foundation. The building overall was 24' by 62' in size. It was divided into three sections: an area on the north end used for cylinder loading; a central area that housed compressors and the third area on the south end that contained the electrolytic cell bank, rectifier, and corridor. The interior has two floors and a mezzanine. The equipment used to make deuterium gas included feed tanks, electrolytic cell bank and rectifier, oxygen cooler, oxygen condensate pot, separators, chillers, seal pots, and deuterium holder. The cylinder loading area contained a de-oxidizer, cooler, compressors, pumps, and pots. The refrigeration area had a refrigeration unit, expansion pot and separator.

WATER FILTRATION AND TREATMENT PLANT (483-D, 483-2D, 483-3D)

This facility was constructed to receive, store and treat raw water from the pump house for use in the powerhouse, process and administration areas. The plant, located in the southwest corner of the building area, consisted of a chemical building, electrical building, softeners and silica absorber building, precipitator basins, filter basins, a flash mixer and pipe gallery, loading and pumping platform and other associated equipment. It was of standard design with the Chemical Building, a Class III construction, as the largest building, sitting adjacent to the raised concrete treatment basins. It also had two support buildings, 483-2D and 483-3D. Both were chemical feed buildings, rectangular in plan with gable roofs and clad with corrugated siding. 483-2D was more narrow than 483-D its functional counterpart. Both were surrounded by tanks and piping.



Facility 483-D, Water Filtration and Treatment Plant. Construction and completion views, 1952 and drawing. Courtesy of SRS Archives, negatives M889-10 and 483-D (above), and drawing W135227 (Opposite).

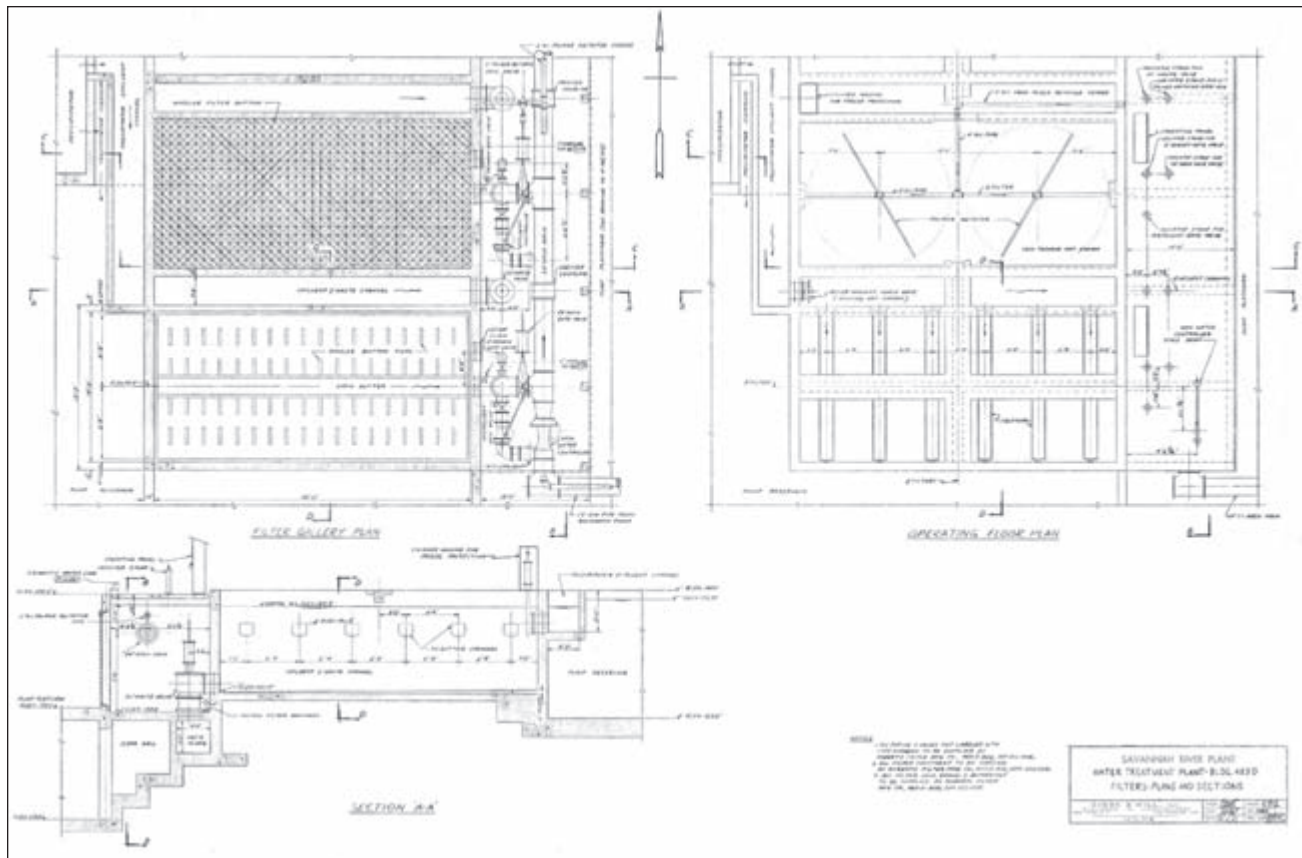

AREA GATEHOUSE AND PATROL HEADQUARTERS (701-1D)

Designed by VWF&S, the gatehouse was the main checkpoint for all personnel and vehicular traffic entering or leaving the building area. It was located on the northeast side of the building area at the main entry to 400/D Area. It was used as the central area facility for area control including emergencies, fire alarm, etc. Generally rectangular, it was a one story building with a Class I section and a Class III section. The former, built for use as a shelter and for the communications operations, measured 51' by 23.' The Class III section, approximately 61' by 46' has a structural steel frame covered by corrugated asbestos siding and roofing. This portion of the building housed the patrol headquarters.

GATE HOUSE (701-2D)

This was a small, square shed roof checkpoint that was manned by two guards whose responsibility was to control railroad traffic to the 400/D Area. It was located in the northern part of the building area, adjacent to the rail entrance to the area. It was a single story, wood frame, Class III building about 10' square in size. The exterior walls were covered with corrugated asbestos boards. It had one personnel doors and windows on every elevation for visibility. It was designed by Voorhees Walker Foley & Smith.

AREA GATEHOUSES, 701-1D, 701-2D, AND 701-3D



Area Gatehouses, 701-1D, 701-2D, and 701-3D. Completion views, elevations, and plans. Courtesy of SRS Archives, negatives 4-486-10, 4-486-11, 4-343-8, drawings W155480, W155731, and W155429.

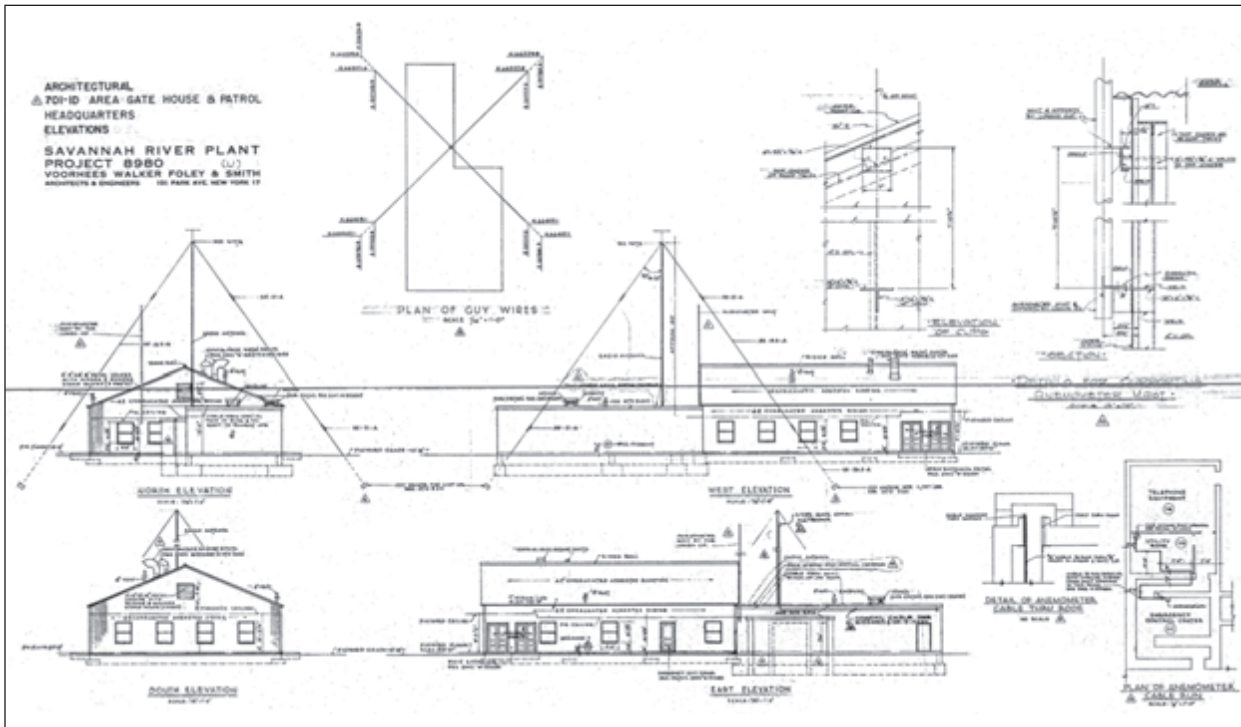

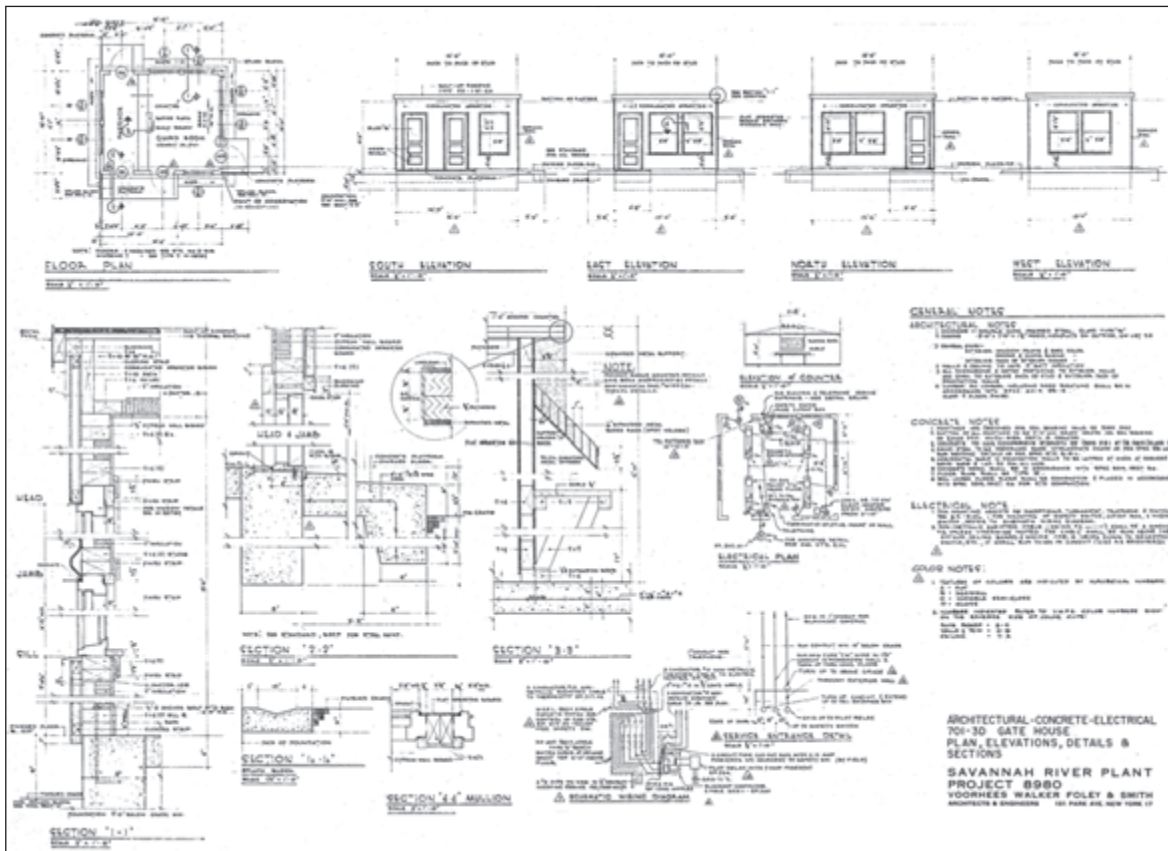
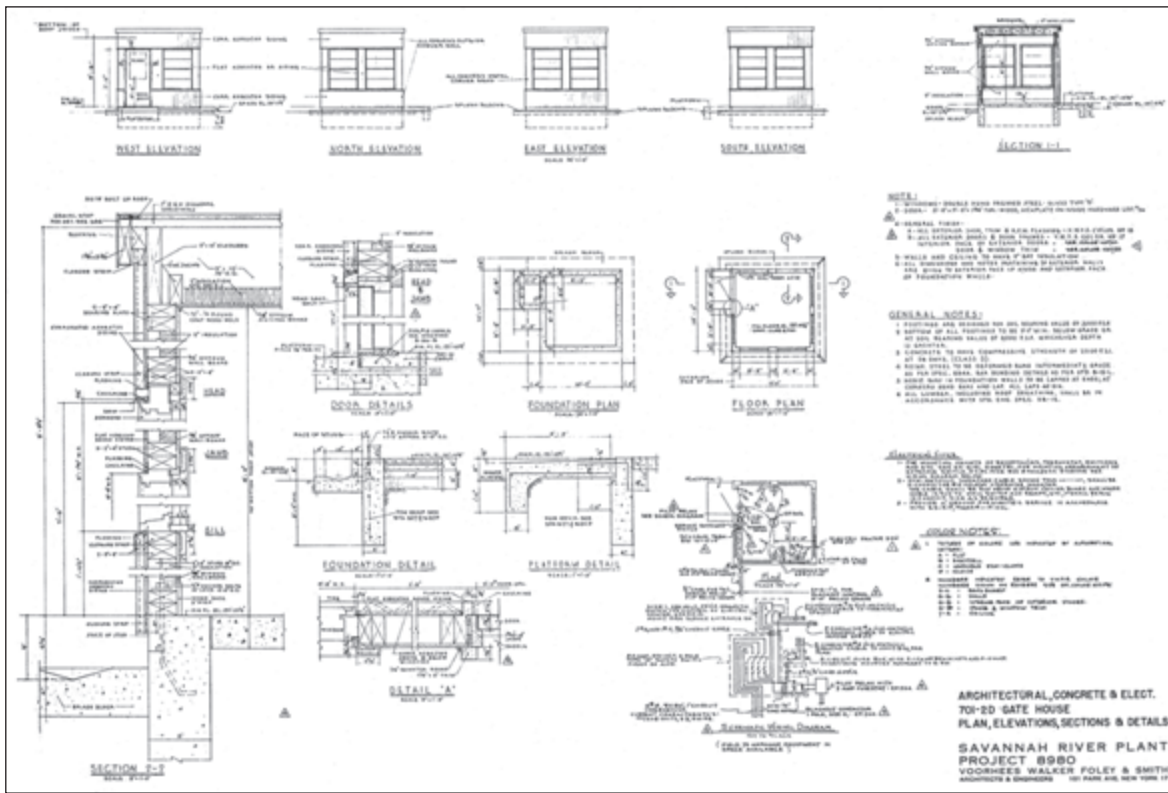

GATE HOUSE (701-3D)

This security building was a control point for the GS units. It was located east of the units between a two-lane vehicle entrance. It also had a pedestrian lane. It was a single story, Class III building, about 13' x 15' in size. It was a wood frame building covered with corrugated asbestos siding and had a built up roof and a concrete foundation. Windows were placed on all elevations and it had two personnel entries. It was designed by VWF&S.

SUPERVISOR'S OFFICE AND FIRST AID (704-D)



This was a T-shaped, one story, Class III building with steel framing and corrugated asbestos siding and roof. It had a gable roof and a reinforced concrete foundation. The larger wing was 180' by 40' while the smaller wing measured approximately 62' by 40.' This was originally designed as a H-shaped building but its design was changed during construction. The Ellenton School had become available for use so the proposed west wing was not needed.

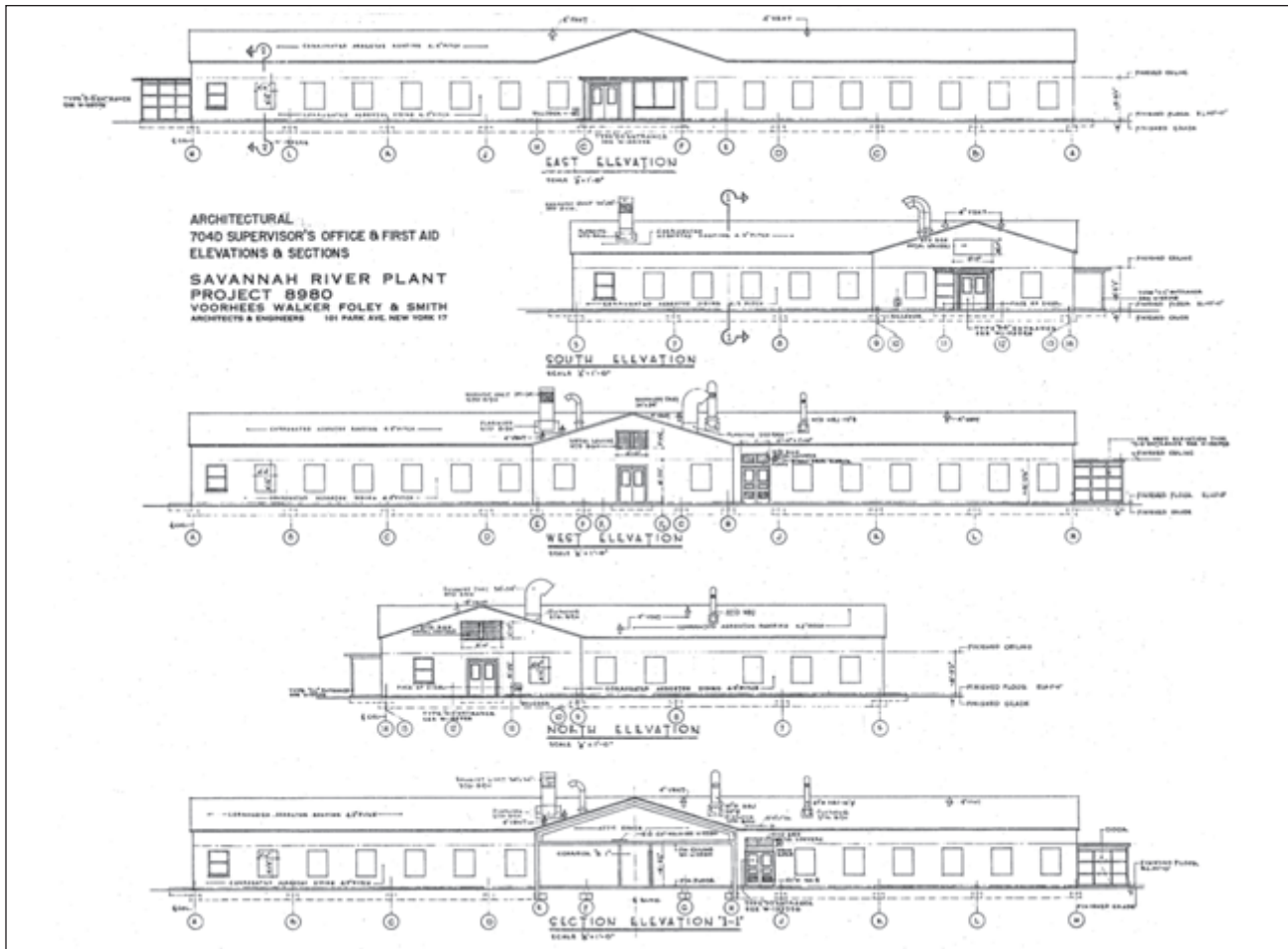

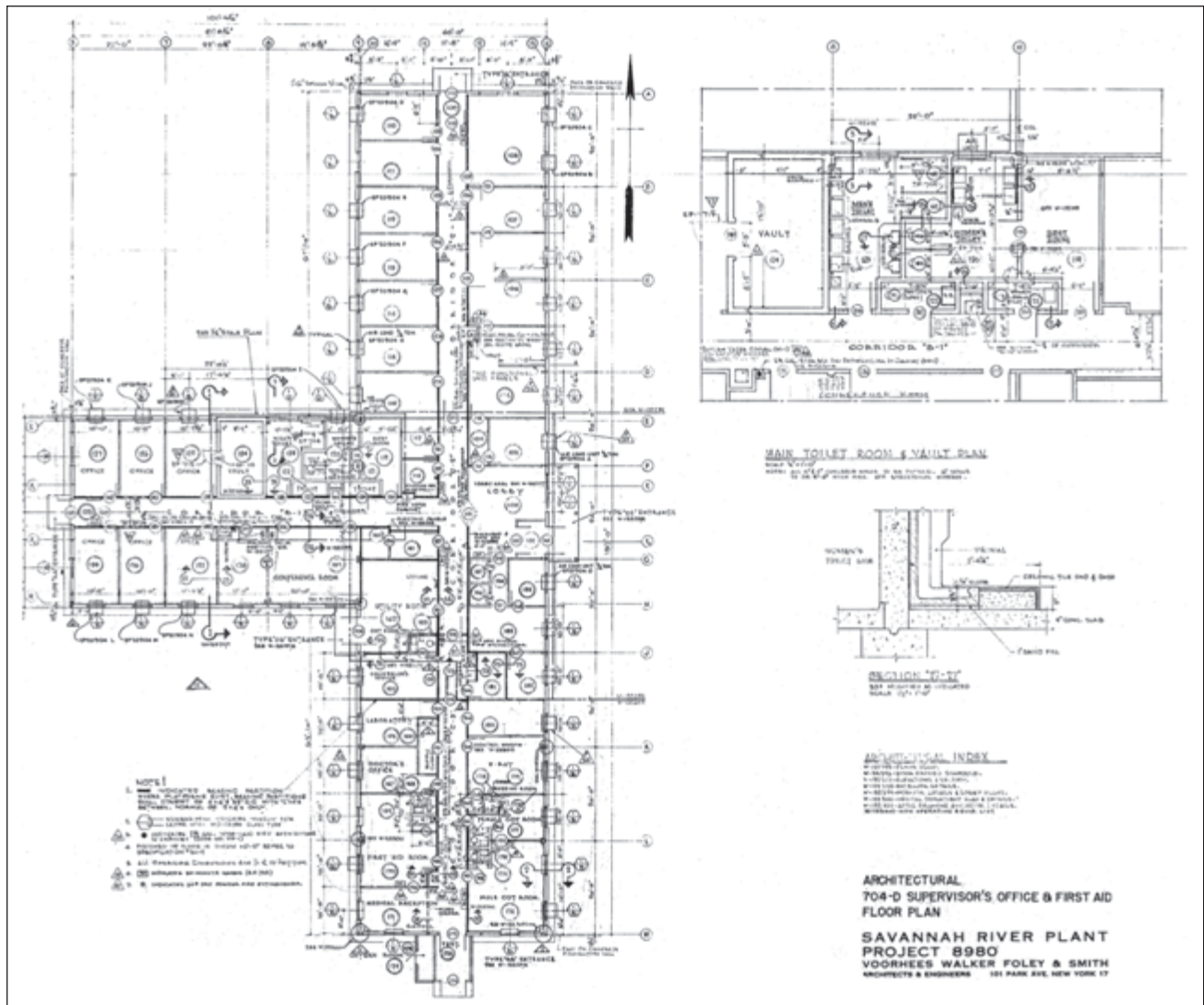

(This Page and Opposite) Building 704-D, Supervisor's Office and First Aid. Historic view, elevations and plan. Courtesy of SRS Archives, negative 4-344 and drawings W155297 and W155295.

It housed 23 administrative offices, training rooms, and first aid facilities. The medical portion housed an office, laboratory, X-ray, dark rooms, a cardiograph room, cots and reception area. It was used as the main medical facility until 719-A was completed in A Area. An entry canopy was added to the Medical wing entry in 1951 for storm protection. It was designed by VWF&S and it was situated by itself on the northwest perimeter of the building area.

CHANGE HOUSE (707-D)

The Change House was a Class III construction used by personnel working in the GS area. It had separate locker rooms, showers and rest room facilities for operators and janitors as well as separate entries. Although not said directly, this refers to segregated facilities as the janitorial staff at the beginning would have been mostly African American. In 1953, a 41-foot extension to the building was made to accommodate Works Engineering personnel in the area.



Building 707-D, Change House. Historic View, 1952. Courtesy of SRS Archives, negative 4-345.

It was a single story, prefabricated building about 82 feet long and 41 feet wide set on a concrete slab with a gable roof and corrugated asbestos exterior walls and roofing.

FIREHOUSE (709-D)

This facility was originally a temporary construction firehouse used during the construction era and it became the firehouse for D area and CMX and TNX areas. It housed a fire truck, fire fighting equipment and personnel. It was a single story, square, wood frame Class III building with a gable roof. It had two oversize garage doors and had cello-siding (corrugated plastic). It was located on the northern edge of the building area.



Building 711-D, Pipe Storage. Historic view, 1952. Courtesy of SRS Archives, negative 4-346-9.

STEEL AND PIPE STORAGE (711-D)

This Class III building was used to shelter pipes, metal, paints, etc. About 20 feet by 58 feet, it was built in two sections. It has a wood frame with corrugated asbestos siding only on the end walls. It is open on two sides and covered by a flat shed roof with projecting eaves to provide more cover for the stored building supplies.

SHOPS, STORES AND CHANGE HOUSE (717-D)



717-D, Shops, Stores and Change House. Historic view, circa 1952, elevations and plan. Courtesy of SRS Archives, negative 4-364-1 and drawing W15319.

This facility, designed by VWF&S, was the central focus for maintenance work, inspections and stores for the area. It contained mostly shops but there were also change room facilities for at least 120 employees including women. No change facilities for janitors were noted on the plan drawing. It was a rectangular, Class III construction about 182 feet by 100 feet in size. It had a structural steel frame, a gable roof, a concrete slab foundation and was clad with corrugated asbestos boards.

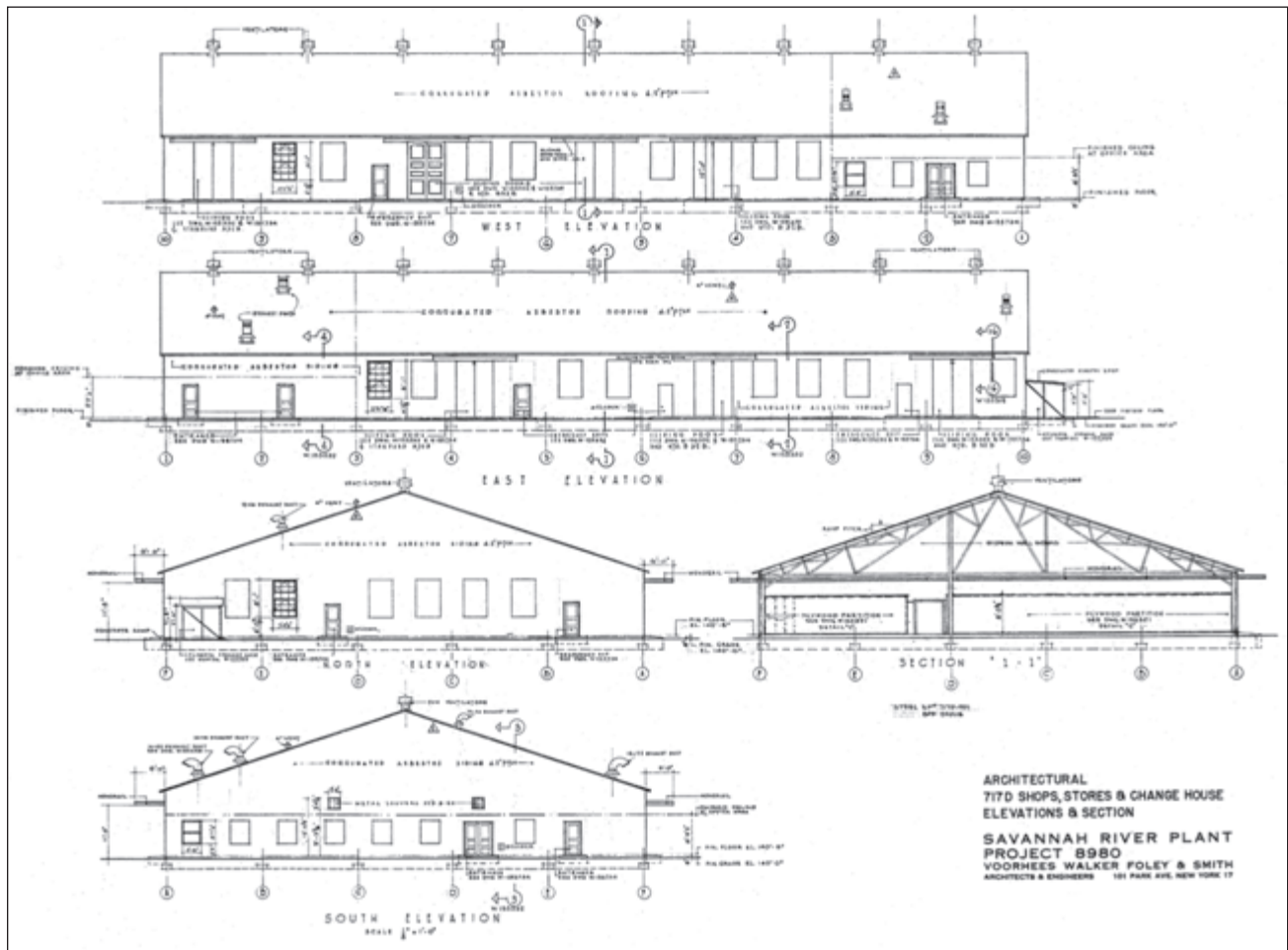

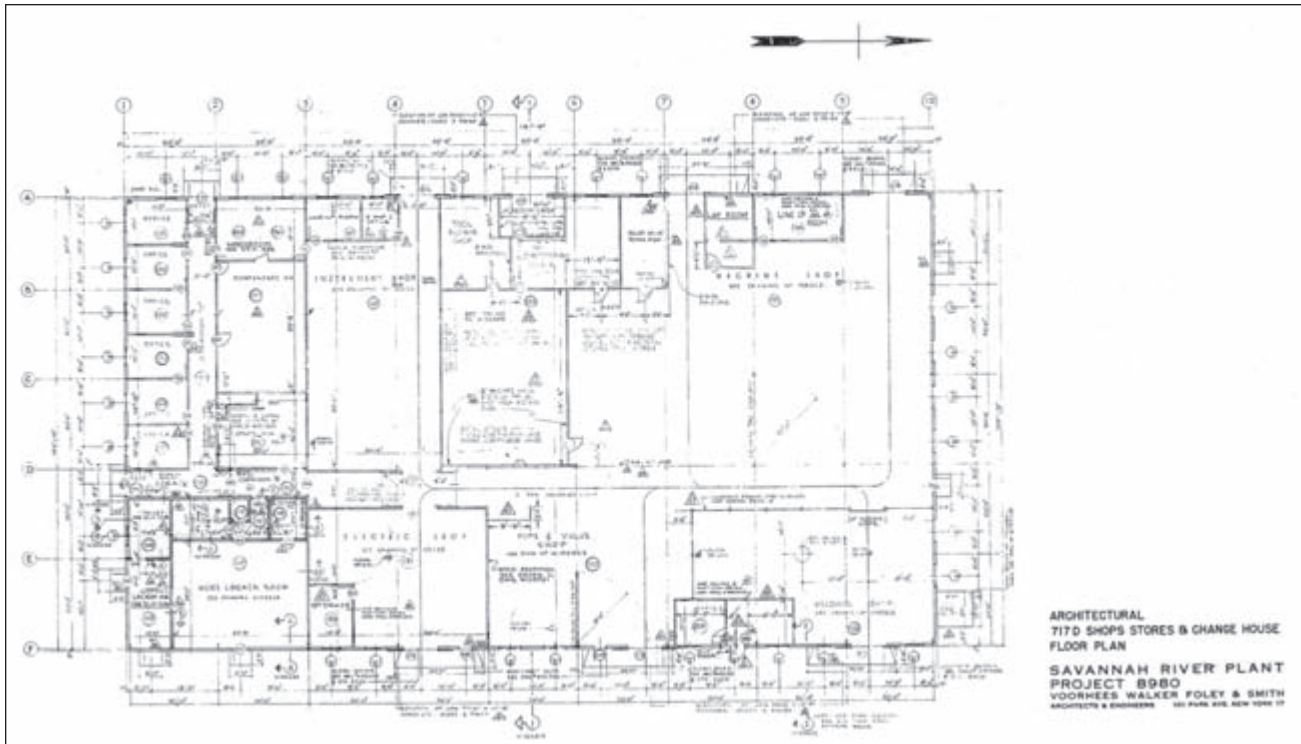

717-D, Shops, Stores and Change House, Plan. Courtesy of SRS Archives, drawing W155318.

CONTROL LABORATORY AND SUPERVISOR'S OFFICE (772-D)

This facility, also designed by VWF&S, contained the laboratory facilities used to control the 400/D Area's processes. It also contained office facilities for the area supervisors and a cafeteria. The building was T-shaped and featured Class III construction. One section was one story, measuring about 38 feet by 202 feet. The second section was 1.5 stories in height but was smaller, measuring 77 feet by 52 feet. It had a structural steel frame on a reinforced concrete foundation. The gable roof was covered with corrugated asbestos roofing and the walls were sided with corrugated asbestos board. The interior walls were Transite or gypsum. Acoustical ceiling tiles were used in the personnel areas. Asphalt tiles covered the floor.



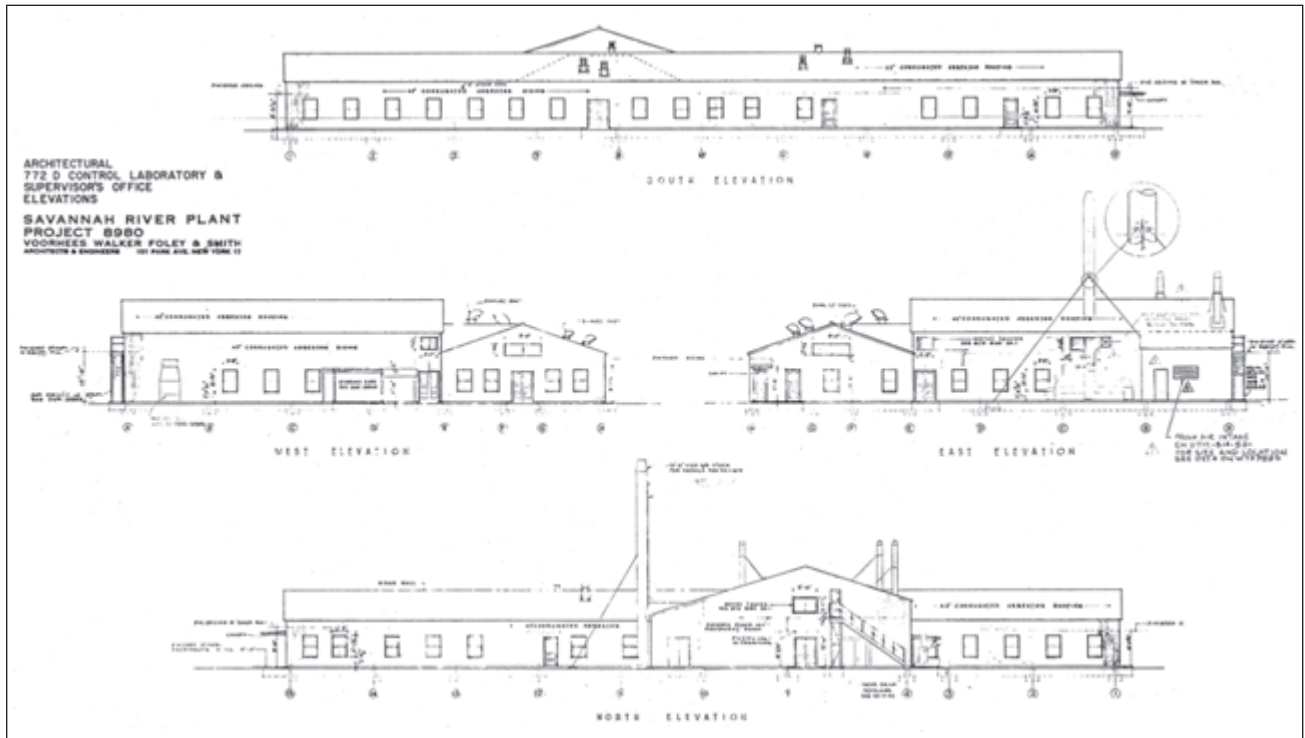

Building 772-D, Control Laboratory and Supervisor's Office. Historic view 1952 (Opposite), elevations and plan (Above and Below). Courtesy of SRS Archives, negative 4-365-1 and drawings W155501 and W155500.

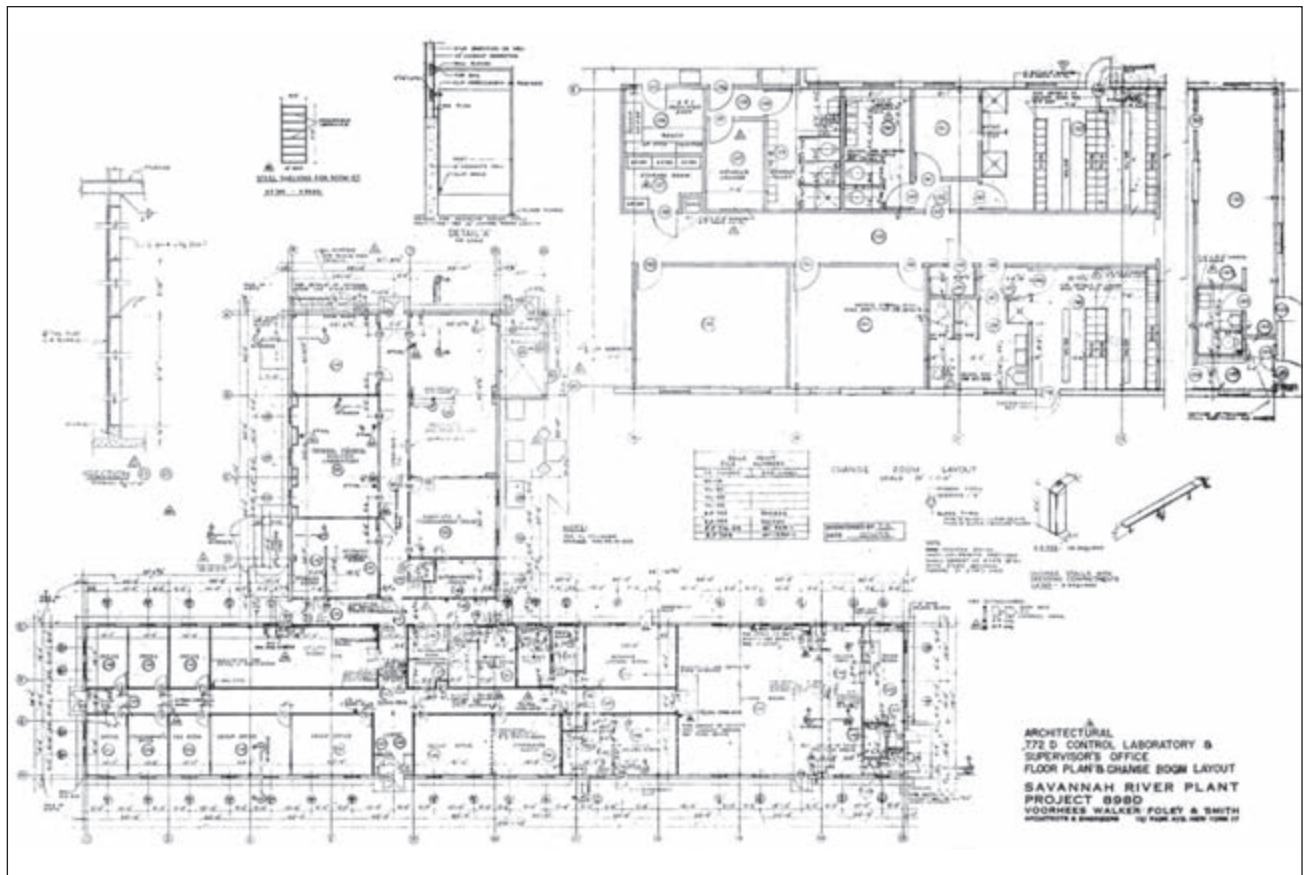

The laboratory section included a Mass Spectrometer Room, a General Chemical Analysis Room, laboratory offices, sample rooms and an area for glass washing and blowing. The General Chemical Analysis Room had laboratory hoods, benches and sinks. A roofed over outside area by the lab was used for the storage of bottled gases. The administrative area was small with seven offices, a conference room, file room and toilet and change facilities for 100 men and women. The cafeteria was described again in a manner that reflects purposeful segregation: “the cafeteria is divided into two sections, an operator’s lunch room with a seating capacity of 84 and a janitor’s section with a seating capacity of 18.” The building was likely designed by VWF&S.

SUMMARY

400/D Area was in operation by May of 1953, a major accomplishment for Du Pont and its subcontractors. While it was larger than Dana, its initial operations varied little from those described in the preceding chapter for the Indiana plant. Start up needs for heavy water for the reactors were met and the operating needs for the first years were based on data rather than forecasts.

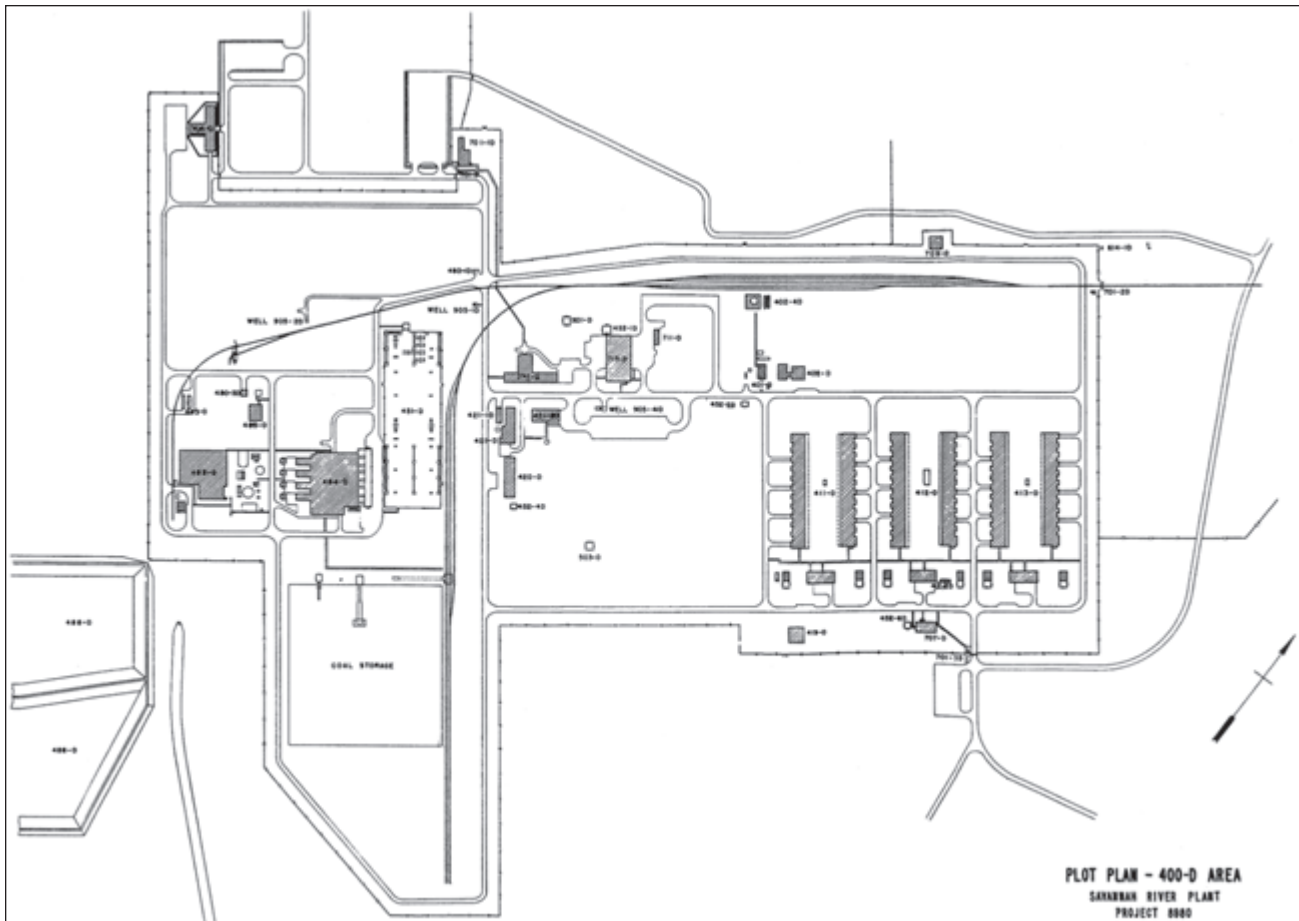

400/D Area as completed, showing three building area blocks with the GS units in the northern “block” accompanied by necessary support buildings, the remaining process buildings and other support buildings clustered in the central block, and power and administrative buildings in the lower block.

In the spring of 1953, a small plant (421-1D) was constructed in D Area to produce deuterium gas from heavy water by electrolysis. Some of this deuterium was used at Savannah River in the Tritium Facility (tritium reservoirs were actually filled with a mixture of tritium and deuterium), and some was sent to the Oak Ridge Site to be converted to the lithium deuteride used in the secondary assemblies of thermonuclear weapons. A second, larger, deuterium plant (421-2D) was constructed in the D Area in 1954.¹⁴

A 1962 estimate of the AEC's capital investment in D Area at Savannah River was quoted at \$145 million with \$110 million, or 75%, of that total devoted to the piping, towers, heat exchangers, structures, instrumentation, and switchgear involved in the GS process. D Area's steam and electric power plant, the largest of all of Savannah River's power facilities, represented a \$15 million investment. The vacuum distillation plant was estimated at \$2.5 million, the electrolytic plant at \$1.5 million, the H₂S plant at \$1 million. The remainder was invested in water treatment, gas storage facilities and flare tower, and general plant facilities.¹⁵

VI. OPERATIONS

DANGERS AND HAZARDS

The GS process used at Dana and at Savannah River's 400 Area involved the use of large quantities of hydrogen sulfide. Hydrogen sulfide is an extremely toxic, flammable gas that forms explosive mixtures with the air. As noted earlier, its odor, similar to that of rotten eggs, is noticeable even from small concentrations, and while some concentrations can be tolerated for a short period, contact can prove fatal. Moreover, after prolonged exposure, individuals lose their ability to smell it, thus exacerbating the danger. Leaks in piping, the distillation towers, or the heat exchangers and any other components within the GS units could cause such a release. While the Flare Tower's purpose was to burn emergency discharge and routine leakage of hydrogen sulfide from the process units, a number of safety measures were designed and implemented at both plants to prevent and guard against any incidents.



400/D Area at SRP. Mass Safety Meeting, 1951. Courtesy of SRS Archives, negative M-410a.



Gas Emergency Drill at 400/D Area at SRP, 1952. Courtesy of SRS Archives, negative M-1055-8a.

At Dana, a gas monitoring division was established in July 1951 and an elaborate communication system put in place. Monitors carried devices to detect leaks, and all personnel were well trained in first aid. Evacuation procedures, if needed, would be given from the monitor headquarters that kept tabs on the wind direction.¹ At SRP, monitoring instruments continuously sampled the air and sounded the alarm when the gas was identified.

Each man carried a small dispenser of H₂S sensitive paper that would reveal presence of the gas even if he could not smell it. All personnel in the area were issued gas masks containing absorbent carbon, and the workers in the units carried masks that had their own cylinders of compressed breathing air.

Perhaps the most important precaution was procedural. Workers in and near the GS units worked in pairs so that if one man was overcome, the other could summon help, put on his own mask and pull his “buddy” to safety. The buddies were required to stay several feet apart so that both would not enter an area of high concentration

(Opposite) 1- Gas Monitors Emergency Drill. Gas monitoring team at work with resuscitator, fully equipped safety carry-all vehicle in background. Courtesy of SRS Archives; 2- Staged safety photograph showing the safety equipment needed for both workers and visitors to D Area. Courtesy of SRS Archives, negative 11328-8; 3- Workers with man in stretcher showing procedure during drill. Courtesy of SRS Archives, negative 1498-2; 4- Flare Tower in operation, 1952. Courtesy of SRS Archives, negative 1273-001; 5- Safety photograph taken outside the gas monitoring office showing four individuals with various safety equipment - Scott packs, mobile phones, gas masks and breathing apparatus to protect workers in case of a gas leak. Each set of equipment is shown separately. Courtesy of SRS Archives, negatives M-947-6, M-947-7, M-947-8, M-947-10, M-947-11, M-947-12.



400/D
AREA SAFETY

simultaneously and both had to have special training. An untrained person entering the GS area had to be accompanied by two trained people.² During operation, when a GS unit needed inspection or maintenance, the hydrogen sulfide gas was returned to the hydrogen sulfide plant in 400 Area where it was compressed and stored in tanks. If an emergency demanded, the gas could be released to a 400-foot flare tower to be ignited by its pilot flame, burned to sulfur dioxide, and released to the atmosphere. The use of these measures gave the 400-Area workers a strong record of safe work performance with no serious injuries from exposure to hydrogen sulfide.³

WORKFORCE

From the outset, Dana had its own administrative offices. In December 1950, the AEC's Dana Area Office's three branches were headed by B. C. Samples. H. N. Hinchman worked in administration. C. W. Reilly was the chief of construction, C. E. Williams was responsible for safety, and F. J. Holtzner handled security. E. J. Grabowski and C. A. Konwinski were in the Technical Branch.⁴

The original lead for Girdler's staff was R. M. Reed, the technical director for the Dana Project. R. E. Alexander was project engineer, and the process engineer was E. R. Comley. On November 1, 1950, there were 389 employees on the Girdler payroll. Peak construction employment occurred in July 1951 with 5,111 employees. The force was reduced by over 2,000; subsequently, on the basis of new estimates, a new peak occurred of 5,458 occurred in February 1952. While some Girdler employees stayed to help orient Du Pont's incoming operations personnel, all of the subcontractor's employees left by mid-January 1951.⁵

From July 1951 to December, Du Pont's forces at Dana grew from 594 to 969 individuals. The total operating force at Dana consisted of 926, of whom 170 were supervisory personnel. The largest number of employees, 405 individuals, was in maintenance, underscoring the need for a strong inspection and proactive maintenance program at the GS facilities. Two hundred and thirty were directly involved with the operation of the process facilities, and 63 worked in technical.⁶

Don A. Miller was Dana's manager initially. He was transferred over to SRP to manage the plant. R. Paige Kelly took over at Dana for Miller, with J. A. Monier as his assistant plant manager. Kelly remained as manager of the plant until it was closed in 1957. Some of the Dana staff would move over to Savannah River, providing a core group of experienced operating and technical staff at the younger plant. J. W. (Bill) Morris served as technical superintendent at Dana until 1953 when he was assigned to the Savannah River Laboratory, and W. C. Scotten, who was part of Dana's Works Technical in 1951–1952, was transferred to SRP in 1952 to serve in Extraction Area Process Assistance.

At Savannah River, organizational charts show that the GS Department or 400 Area was one of six departments under Du Pont's Production Department. F. H. Endorf was head of the GS Department and J. H. Nuzum was area superintendent in 1954, with A. J. Sauerborn as area superintendent for finishing. A Heavy Water Technology

1. D Area Committee, 1956 included Les Ahrens, GS department superintendent; J. H. Nuzum, area superintendent; S. P. Brown, Captain Herman Caldwell, H. R. Casebolt, L. R. Di Fillipo, H. V. Graybeal, W. H. Keeter, W. S. Marting, H. M. Moore, R. D. Pillsbury, Dr. George A. Poda, R.M. Radford, K. W. Brendell, M. A. Werner, and A. D. Williams. The Area committee (not all shown) was composed of individuals from different departments within 400/D. Source: Savannah River Plant News, November 9, 1956; 2- 400/D leaders pose with DuPont model of a GS unit. Courtesy of SRS Archives, negative 14704-002; 3- Control room operator, GS Units. Courtesy of SRS Archives, negative 4377-008; 4- Don Law, Reporter for the SRP News and Views, in 400/D Area for Safety Story. Courtesy of SRS Archives, negative 11328-009.



HEAVY WATER SCENES

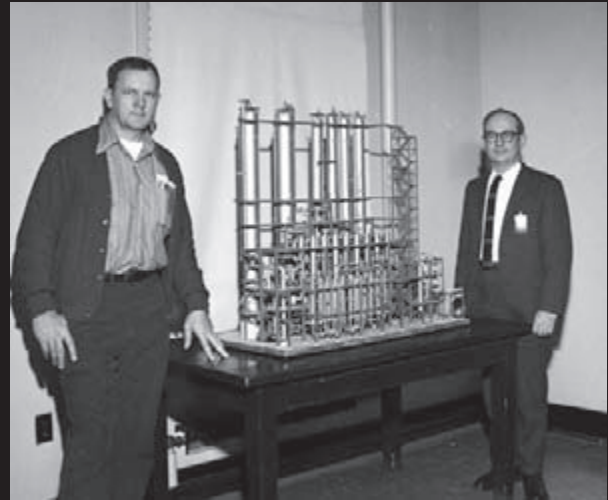

Section, with W. P. Bebbington as superintendent, provided process, mechanical, and operational assistance to the GS Department that held responsibility for 400 Area operations in 1954.

Les G. Ahrens became superintendent of the GS Department in 1956 and J. H. Nuzum remained as the area superintendent. The early workforce of about 900 operations staff was drawn from a number of Du Pont’s departments including Reactor and Reactor Materials Works Technical, Health Physics, Instruments, Service, Maintenance, Traffic and Transportation, and Power and Security. Ahrens remained superintendent until 1964 when Ken French, who was also responsible for the Heavy Water Components Test Reactor (HWCTR), was assigned to the GS Department as superintendent.

PRODUCTION

The required quantity of heavy water for each of Savannah River’s reactor was 200 tons; the Process Development Pile, a test reactor in the 300 Area, required 110 tons. As the Dana Plant and D Area went into operation, estimates on production levels could be made. On the basis of production figures for Dana, then D Area between May 1952 and March 1953, it was projected that the quantity needed to charge the reactors would not be produced until 1955.⁷ This production schedule worked well as the plants, sized to produce the necessary amount of heavy water to charge the reactors, produced sufficient heavy water for each reactor as it was constructed. The staged construction of the five reactors thus was linked to the heavy-water production rate that progressively increased in output.

Table 3. HEAVY WATER PRODUCTION, 1952–1953

| YEAR/DATE | DANA PLANT | 400/D AREA | TOTAL (TONS) |
|--------------|------------|------------|--------------|
| 1952 MAY | 0.83 | | 0.83 |
| JUNE | 2.50 | | 3.33 |
| JULY | 5.33 | | 8.66 |
| AUGUST | 9.25 | 0.68 | 18.59 |
| SEPTEMBER | 13.80 | 2.02 | 34.41 |
| OCTOBER | 15.00 | 4.93 | 54.34 |
| NOVEMBER | 15.00 | 7.59 | 76.93 |
| DECEMBER | 15.00 | 10.50 | 131.83 |
| 1953 JANUARY | 16.00 | 13.40 | 131.83 |
| FEBRUARY | 16.00 | 16.10 | 163.93 |
| MARCH | 16.00 | 16.80 | 196.73 |

Source: Control Division, “Heavy Water Production and Production Costs Fiscal Year 1951 Through August of Fiscal Year 1956,” DPW-4742-1, March 11, 1952. National Archives, Records of the Atomic Energy Division, A-1957, Series II, Box 45, Folder 14.

The need to continue heavy water production lessened after the reactors were in operation and an adequate stock of heavy water had been stored for future use. Both plants were designed for a production rate of 240 tons of heavy water per year; they exceeded these original projections after three years in operation.⁸ In 1956, the GS Department's net production of heavy water was 478.13 tons.⁹

The initial objective met, Du Pont's workforce then aimed at increasing production while lowering cost. In 1954 the direct cost of producing a pound of heavy water was \$15.69, a year later it was reduced to \$11.10 per pound. Subsequent years show further reductions as process improvement occurred. By 1957, the direct unit cost per pound for heavy water had fallen to \$9.23. In 1958, it was produced at a direct cost of \$8.37.

Table 4. HEAVY WATER PRODUCTION, 1955–1958

| Year | Heavy Water Extracted (pounds) | Hydrogen sulfide (pounds) | Distillation (pounds) | Electrolysis Production (pounds) | Electrolysis Rework (pounds) |
|------|--------------------------------|-----------------------------|-----------------------|----------------------------------|------------------------------|
| 1955 | 830,688 | 696.5 | 872,492 | 1,027,286 | 188,787 |
| 1956 | 913,529 | 439 (Operated only 59 days) | 1,024,019 | 977,148 | 75,417 |
| 1957 | 951,697 | 390 tons | 1,117,948 | 1,141,000 | 202,695 |
| 1958 | 657,025 | 286 tons | 806,118 | 943,592 | 364,456 |

In 1957–1958, the Dana Plant and two thirds of Savannah River's D Area GS units (Facilities 411-D and 413-D) were shut down. The plants had proven successful, producing sufficient heavy water for SRP reactors including the test reactor and a stockpile for other uses. Dana's closure was predicated on needed repairs that would have

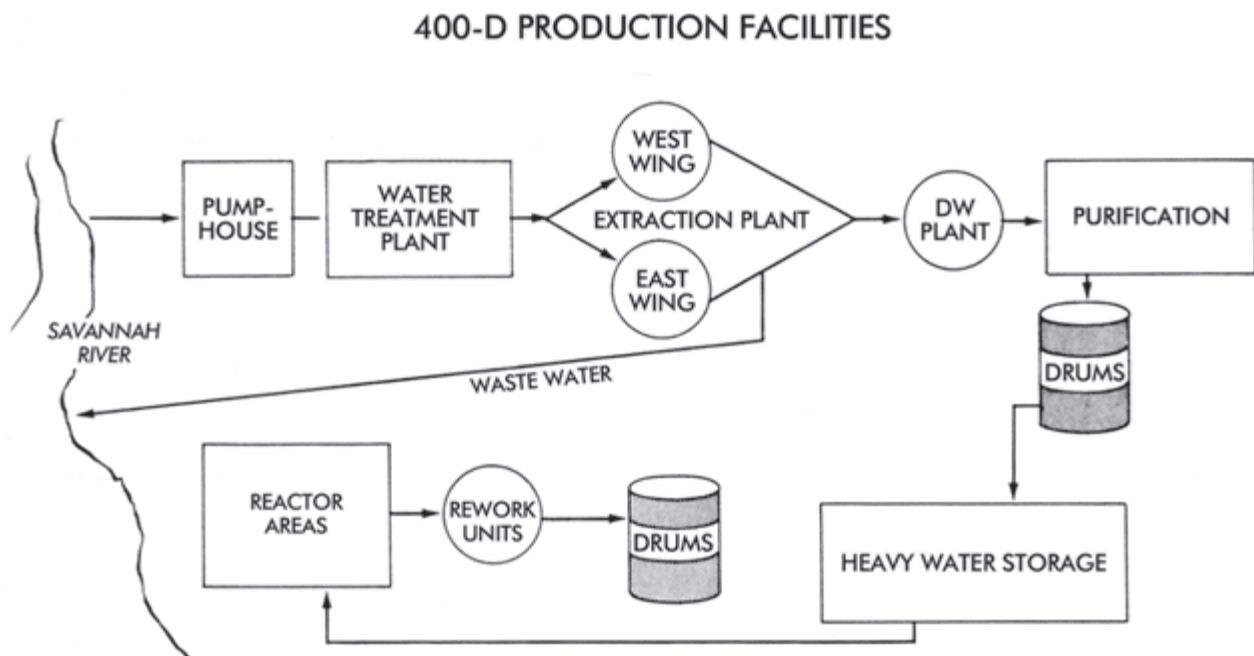

Diagram of D Area Processes, circa 1962. Source: W. P. Bebbington, J. F. Proctor, W. C. Scotten, and V. R. Thayer, "Production of Heavy Water in the United States" in Proc. Third International Conference on the Peaceful Uses of Atomic Energy, Vol. 12 Nuclear Fuels-III Raw Materials (New York: United Nations, 1965), 334.



(Above and Below) Details showing early dismantlement and aerial view of 400/D Area with 411-D, 412-D removed. Courtesy of SRS Archives, negatives 16597-14 and 34268-18.



proved costly and slightly lower productivity levels that stemmed from the GS unit's complicated design. The same winnowing occurred at SRP. The GS unit with unclad towers, suffering from more corrosion than its counterparts, was dismantled beginning on October 4, 1957. The E Plant was also shut down as the concentration of the final product could be handled in the DW Plant without a "significant loss in production."¹⁰

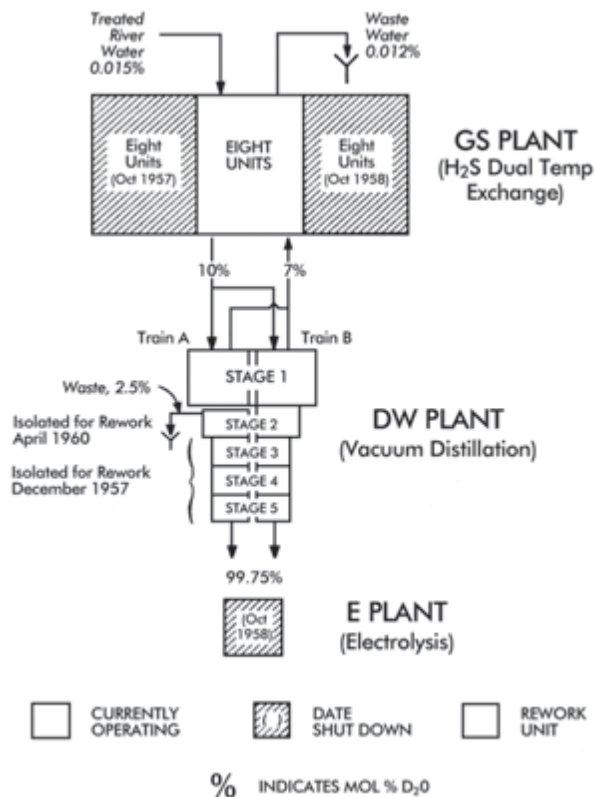

Flow Chart Showing Processes in D Area, 1970s. Source: D Area Tour Booklet, not dated.

Between 1959 and 1964, D Area would steadily lose more staff. In 1964, a force of 322 produced 345.26 tons of heavy water.¹³ Total production of heavy water grew between 1959 and 1964 as the operating staff worked with economy and focus with the remaining facilities. The plant histories for this time period show rework assuming greater importance in D Area's operation, while the costs of maintaining older facilities, now closed down, grew steadily.

"ITS PRODUCTS GO FAR"

Heavy water was the Savannah River Plant's first direct contribution to the Atomic Energy Commission's vigorous campaign to develop atomic energy for peaceful purposes. When Commission Chairman Lewis L. Strauss visited the plant in March of 1955, he announced that the United States had agreed in principle to sell 10 tons of heavy water to the Italian government for use in Italy's first research reactor.¹⁴ The market price in 1956 for heavy water was \$28 a pound or \$14,000 a drum. By 1957, Sweden, Canada, Switzerland, France, Australia, Norway, and the United Kingdom had received substantial shipments of Savannah River and Dana's heavy water for use in

As a result, Dana's staff was reduced to a skeleton crew of 12; some members of the operations staff reported to Savannah River's GS Department. However, the closing of D Area facilities also reduced the staff at Savannah River. In 1957, D Area had 588 employees, after 145 positions had been cut in response to the closing of Building 411-D. More than 149 jobs were cut the next year when Building 413-D was closed, reducing the D Area workforce to 435.¹¹ In 1959, a workforce of 395 produced 185.33 tons of heavy water in the remaining eight extraction units in Building 412-D and 9 of the 12 towers in the DW plant. The other three DW towers were used as a rework unit for the reconcentration of degraded heavy water from the reactors containing tritium.¹²

Du Pont was officially released from responsibility for the Dana Plant in July of 1959 after the purging of all equipment with nitrogen. The U.S. Army Corps of Engineers assumed responsibility for the plant at that time.

Cartoon figure illustration on US sales of heavy water. Source: Savannah River Laboratory, Nucleonics of Tomorrow in the Making Here Today (Aiken, South Carolina: E. I. du Pont de Nemours and Company, not dated)

The Savannah River Plant makes practically all of the free world's supply of heavy water. A sensation was created at Geneva in 1955 when the AEC offered to sell D₂O at one-third of the previous world price. Already, more than \$23 million worth have been sold.



(Left and Below) Tests and preparations for 1969 shipment of heavy water valued at \$9 million to Sweden. In 1969, the AEC negotiated sales of 450 tons of heavy water for an approximate value of \$42 million. Courtesy of SRS Archives, negatives DPSPF 12818-8 and 12818-11.



research reactors and incipient power reactor programs. Italy, Denmark, Japan, Israel, West Germany, New Zealand, Pakistan, and South Africa had pending commitments with the AEC for purchase of the plant's heavy water through the Commission's "Atoms for Peace" agreements.¹⁵

Sales continued briskly through the 1970s. In 1970, a final shipment for a \$27 million dollar sale of heavy water for use in Canada's Ontario Hydro Pickering Station rolled offsite in tractor trailers. Pickering Station was one of four reactors being built by the Ontario Hydro-Electric Commission near Toronto.¹⁶ The national laboratories also received heavy water from SRP and Dana; Brookhaven National Laboratory received 100 tons of Dana's product in 1966 after the Indiana plant closed.¹⁷

HEAVY WATER TECHNOLOGY AND EXPERTISE

While Savannah River's heavy water traveled far, so did its technology and its operations know-how. The AEC and Savannah River, under a bilateral agreement between the USA and Canada, worked cooperatively with Atomic Energy of Canada, Ltd., in the overall field of heavy water production and heavy water reactors. Canada's decision to found their commercial nuclear power industry on heavy-water-moderated reactors solidified earlier technological ties between the U.S. and Canada that had developed during World War II. Canadian researchers were able to learn from operations staff. They watched closely Savannah River's operation of the Heavy Water Components Test Reactor between 1962 and 1964, even sending a researcher to participate in the project

Poster display on heavy water nuclear power reactors showing the Heavy Water Components Test Reactor (HWCTR) built at SRP. HWCTR was constructed to provide information about the operation of a projected power reactor that used heavy water as a moderator. Research at the \$9 million dollar test reactor constructed in B Area was conducted by both American and Canadian scientists. Fuel data from the test reactor was used in the operation of the Carolinas-Virginia Power Associates demonstration power reactor at Parr, South Carolina. Courtesy of SRS Archives, negative 9885-1.

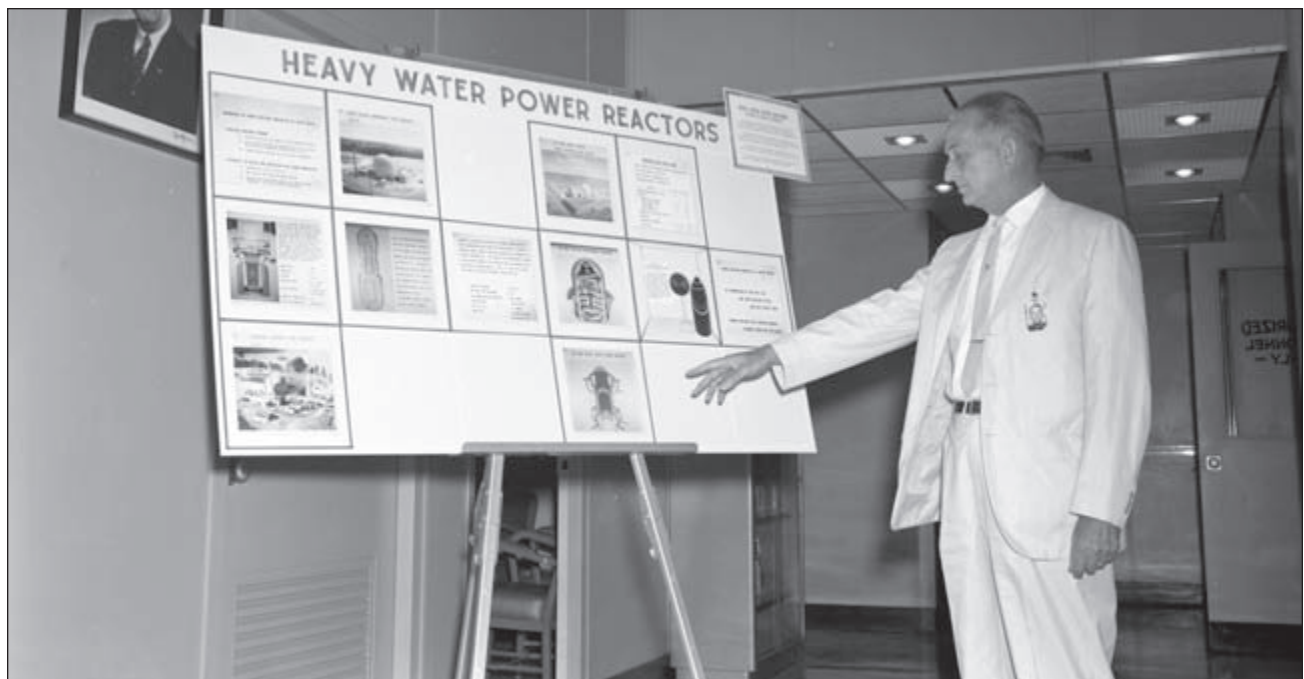

launched under the auspices of the Atoms for Peace Program. Other countries interested in heavy water technology, including India and Argentina, also benefited from the experience of Savannah River's heavy water experts. The 400 Area hosted chemical engineers from India, providing them with first-hand knowledge of large-scale, heavy water production.

The first heavy water plant constructed outside of the USA was built at Glace Bay on Cape Breton Island, Canada, as a joint venture between Deuterium of Canada Ltd. (DCL) and the province of Nova Scotia. The plant was unable to operate as designed, and Du Pont was asked to consult in diagnosing the problems and in offering recommendations for future operation. Bebbington notes that the plant was rebuilt with modifications that were patented by a retired Du Pont heavy water expert.¹⁸ The La Glace facility was to have supplied heavy water for an Argentinian reactor. Due to delays at the Canadian facility, Argentina acquired heavy water from the AEC that had been taken from Savannah River's L Reactor, then on standby. Later Canadian heavy water plants built by General Electric of Canada Ltd. and Ontario Hydroelectric also benefited from experience gained from the design and operation of heavy water facilities at Dana and Savannah River. Du Pont engineers were involved in each Canadian plant, and Canadian representatives were sent to Savannah River to learn from D Area operations. With the closure of D Area, these Canadian facilities became the world's largest heavy water production facilities.

The last of the heavy water production units (412-D) was shut down in 1982. The area had been in operation for over 29 years and had produced a sufficient amount of heavy water for the then three operating reactors, a reserve stock, and deuterium for use in weapons components. Notably 37 percent of the personnel in 1982 had remained in D Area since startup. Plant Manager John Granaghan, on hand for the occasion, noted that while a contingent of employees would stay on, the majority would be shifted over to the L-Area reactor restart program, as well as other project assignments.

VII. CLOSURE

Between 1951 and 1982, the towers erected in Savannah River's D Area and at the Dana Plant in Indiana yielded about 7,500 tons of heavy water for the nation's atomic energy program. The Dana Plant operated from 1951 until 1957, when an adequate supply of heavy water was on hand. Two of Savannah River's three GS units were closed in 1957–1958 for the same reason, leaving one in successful operation through 1982.



Tom Ansley, operator in D Area, far left, turns off process water in SRP's last heavy water production facility on January 8, 1982. From left to right, Production General Superintendent Joe Womack, Works Engineering General Superintendent Ben New, Senior Supervisor Don Bowman, Plant Manager John Granaghan, and Assistant Production manager Dixie Hendrick. Courtesy of SRS Archives, negative 3403-13.

While the Dana Plant slipped back into the hands of the Corps of Engineers after it was decommissioned, D Area had an afterlife after 1982. As noted, a small staff remained at D Area to shepherd what remained of the heavy water mission – rework and purification rather than production. The GS unit area was transformed into a site with only its concrete pedestals and remnant support buildings left to tell its story. The steel towers were excessed and sold to be recycled for use elsewhere or for scrap metal early on. What was left was later used as a training area for site fire fighters. The remaining process buildings were used as long as needed then deactivated. The service buildings housed office staff and project related personnel for purposes unrelated to heavy water production. The powerhouse and ancillary facilities were leased to South Carolina Electric and Gas (SCE&G) in the 1980s and the lease remains in effect today. The infrastructure “block” of power buildings is the only part of the once thriving area that remains intact and in use.

With the shutdown of all the SRS reactors in 1989 and with an adequate stockpile of heavy water on hand, the need for future production and even rework ended. D Area was one of the first building areas to be identified for deactivation and decommissioning. These efforts really aimed at completing a task that began much earlier when the first GS unit was shutdown in 1957.

Dana and the 400/D Area were part of an intense creative technological era driven by the Cold War. But they are also the bridge between the Manhattan Project and the Cold War as heavy water technology was a product of World War II research. It would be left to Du Pont to move the process from the laboratory to full-scale production that was a significant accomplishment. Morris et al. recollect the camaraderie that existed between the sister plants along with good-natured competition in safety and productivity. The heavy water they produced for our nation's production reactors and the heavy water that led to nuclear energy research around the world and Savannah River Plant's first "Atoms for Peace" product, is a remarkable legacy.

VIII. INSIDE PERSPECTIVES

This chapter contains the recollections of individuals that are part of the heavy water production story at Dana and SRP. These are excerpts from the oral history interviews that are presented in full in Appendix A. In the first, early days at Dana are recalled by Mr. Don Duarte. The memories of Elsie Wood Smith crackle with the highs and lows of starting one's first job at a nuclear production plant. Ms. Smith is followed by the big picture view of a young chemical engineer who became a leader at the plant and ultimately compiled a history of DuPont's work at the Savannah River Plant, Dr. William P. Bebbington. Mr. Mitch Burgess and Mr. Richard Shulko provide details about typical worklife in the 400/D Area and the concerns involved. Mr. Lee Poe finishes the chapter with a description of his job as a technical support specialist in the early days at SRP, describing column and flare tower inspections as well as details about everyday work life from carpooling to mosquito control.

TERRIBLE HAUTE, BUBBLE CAP TOWERS, AND ROTTEN EGGS (DON DUARTE)

I hired in with DuPont in June 1952 and reported to [the] Dana Plant at that time and left there in March 1953. The rest of my employment was at the Savannah River Plant from April 1953 through August 1990. I was a supervisor with DuPont.

All of my time associated with heavy water was at Dana. Heavy water. But, as I told you, that was like a Pilot Plant. As soon as the 400 Area here got going, which was shortly after I left there, (I'm not sure; it was probably sometime into 1954 maybe), they shut down the Dana Plant and they used it as a Pilot Plant. The 400 Area of course learned from it.

For me [a typical day at Dana] began in "Terrible Haute," Terre Haute, Indiana. I stayed there in the "Y"; I was single and just out of school, so I stayed there. I didn't have a car and I got picked up, and most of the time I was there I was on shift. Shift work is reporting in 10 minutes early and getting a turnover and then going about your business. We had a control room watching what the charts told us. Then you might have something to do in the facility; like, you might have some maintenance that you'd have to go out and follow or point out what had to be done when we were there starting up the units. It was just regular production work. Get your turnover, find out what had to be followed up and then when things came up, make sure the process was running right and keep up with maintenance, whatever. Of course, days were the worse time. When you rotated on shifts and you came on days and everybody came in when you did and unfortunately you had everybody telling you what to do. Nobody who works shift work likes days for that reason. There were always the chiefs there telling you what to do. You know it's just an added thing; part of the job. But when you're on shift, you got one guy telling you what to do, and you do that, and then there were other things. If you were on days, like Lee Poe would come up to you. He was in what they called the [Reactor] Technical group. He would ask you questions. So he had additional people talking to you. That's just what happens all the time in every plant, no matter where you are.

Oh the [night shift] was always fun; no, not really. Especially— part of time, see I was hired in June so I was there through the winter and you have snow and icy conditions [at Dana]. When you travel, I think it was about 40 miles, it can be dangerous and plus that, there's always a danger at midnights when you're coming home. The driver, guys try to stay up and watch the driver, but they fall asleep. So it's up to the driver. Sometimes it's pretty scary for the drivers, trying to stay awake.



Labor Meeting, Night Shift, D Area, 1952. Courtesy of SRS Archives, negative M-646 -2.

Well, both Dana and the Savannah River Plant were both operated by DuPont, under contract with the Government. At that time I think it was AEC. So Dupont, as they did here, hired people like me just out of school and probably some hired people from other industries. Again, I can't think of any off hand, but they also as they did when they operated the Hanford Plant, transferred a lot of people from their commercial plants to there and to here. Some of them they transferred to Dana and to here, mostly to here, where people had operated at Hanford for Dupont before. But I don't know if they had any or many at Dana. They were either, well some of them, that part of history I can't remember because I didn't have much time to talk to people and so forth. I was just new out of school and I was getting acquainted and all that.

When I got to Dana they were in the process of starting up the bubble cap towers. That was the first step in the process. All of them were not on the line yet. They were still getting them turned over from construction. I don't know about the pilot plant. As a matter of fact, I don't remember a pilot plant there for the bubble cap towers. I

don't think they had one, but anyway, we had problems of course just starting up. Any time you start up a major facility there are problems.

[Dana] had three major manufacturing areas. There were the bubble cap towers where they took water and through the process, enriched it. Then it went from there to steam distillation... where it's probably, I'll say, 90% heavy water. Then they put it through the electrolytic process. That took it up, I guess, close to 100% heavy water.

It [the process] would take normal water out of the river and concentrate it. The way they concentrated it was by passing the H_2S gas counter-current to the water. They would do this through several towers. Each tower had, I don't know, say forty trays or something like that and the water would be pouring down from the bottom and the gas would be blowing up through it. And by reaction with the H_2S at each tray, there would be a small amount of concentration, and as the water came down through each tray, it would be concentrated. But, there were several stages: after the water left there—like when it was going through the first stage, it might have only been concentrated at .0055. Then it would go through the second stage and the same thing would happen. That water would bubble down and the gas would be pushed up through it, and it had like 40 or 50 trays. At each tray, there'd be a small amount of concentration and when it finally came out it would overall be concentrated. Then that would pump through the next stage. It'd finally get up to 3-5% and then go to steam distillation.

You see, you start with a very, very low concentration, like below 1% and you concentrate all the way up to 100%. I mean if you didn't return the water to the Wabash River, it would run dry! I'm just kidding about that, but there was enormous volume of water [used].

Because a lot of reactions proceed better when it is warm, those towers—the initial stages, which is the only thing it would make any difference—were heated. By that [I mean], they were insulated and had steam tracing on them. The water was not pre-heated, I don't believe. We didn't have any heat exchangers on the line, so the water came in cold but I would think that in that little a short time it wouldn't make much difference. But, what did make a difference is that in the winter time you had to worry about ice on the [towers]—see, you had to climb to various stages of the towers to get sample points. So you had to climb the various stages of the towers and if it rained or snowed or whatever, you know open grating gets pretty dangerous. That was one of the safety things that.... As far as the process, I don't really know but if I had to guess I would say that was insignificant. I think what they did, and I'm guessing, is that they used that as a pilot plant. They got it going good down here and then they had heavy water right here.

They had to recycle [heavy water at SRP]. When it went through the reactor once, they had to recycle it. So they had the facilities right here. There's no use having a facility here and a facility there. This was—although the Dana Plant got operating pretty well; they resolved the problems. From the things that were learned there I understand they made changes in the process down here and in the equipment. So, it [400 Area] was a better place to work. I would say an outside figure would be 500 [workforce at Dana] and I would include everybody in that, including maintenance and operating.

I don't remember much about [security at Dana]. I don't think there was hardly anything to it, because that was in the early days and when it came to the Savannah River Plant it was about the same way. All you had perimeter security. You didn't have any area security. You just passed through a checkpoint and that was it. I think that's about it for Dana. I don't remember guards going around or anything like that.

...When you work for Dupont, when you read something, there's some safety note there. As a matter of fact, all procedures start out with safety; wear your mask or carry it or whatever. The big safety issue with the gas is that if you sniff enough of it you don't smell it. Well, if you smell it you'd better get out of there because you're going to get to the point where you won't smell it. It's H_2S , you know, that's rotten egg. It's a heavy gas and it lies in low places. So if you go along a ditch, that's the worse place you can get it. If you go in a closed area, that's the worse place. If you got a wind blowing, that's good. You know the way it works? It's a gas that paralyzes your olfactory nerves, and so if you sniff it long enough you won't smell it and you can get it in a heavier concentration and not know the difference. If you initially smell it, that's the time to get out of there. While I was there, they had a couple of guys that got enough so they passed out from it, but there were no fatalities from that; they took them to First Aid and that's it.

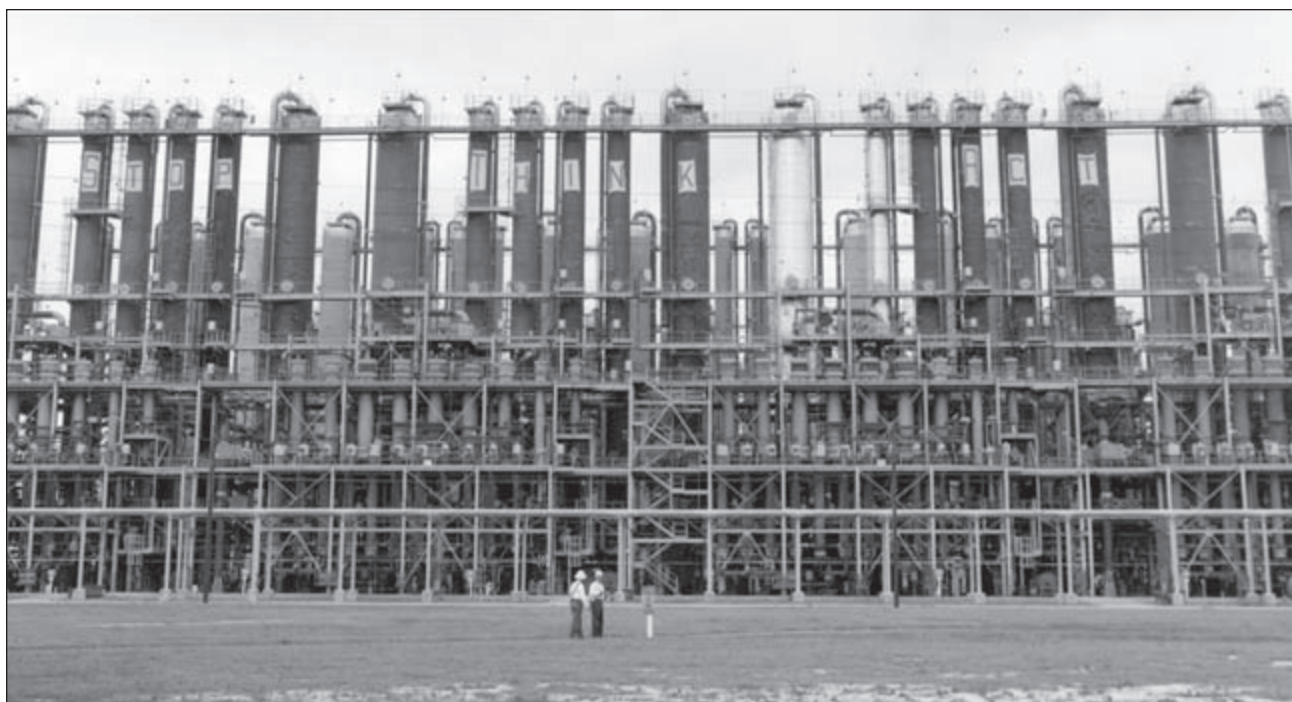

STOP THINK ACT. Safety signs mounted on GS towers, 400/D Area, 1956. Courtesy of SRS Archives, negative 3970-3.

The first thing is containment. You got to keep the stuff where it is. If anything leaked, you had to get it replaced right off the bat. We carried around a mask, that's what I remember, and there were also Scot Air Pak stations throughout the facility. Then you had drills, you know, trying to respond to whatever was going on. I think they had teams of guys set up. Like I say you didn't want to smell it always; so, no. You know people make fun of the smell because it smells like something else besides rotten eggs. But there was not enough of it around because it was dangerous, so you very rarely smelled it.



Safety drill. Courtesy of SRS Archives, negative M-410b..

I came down here in June 1953 and they started up and got going good, and [then] I think they closed down [Dana]. As a matter of fact it surprised me how fast they closed it, but I would guess in 1954, given a full year, at the end of 1954 because what happened, what scuttlebutt I got is, that although Dana solved their problems, and was running well, that Savannah River learned from them and was running better. And so, they decided to close it down.

NOW, WHATEVER YOU DO, DON'T LET THEM SEND YOU TO 400 AREA...- ELSIE WOOD SMITH

I came to work out there right out of high school when I was 18 years old, in 1953. And my first job was in 400 Area. I worked in 400 Area for a year, and then I transferred to F Area, and I worked in 773-D. This was 1954.

[I grew up] In Barrow County, Winder, Georgia. Well, when I graduated from high school, I had an uncle that was working at the Pontiac place in Aiken, and he was here when the building blew up downtime. And he came back to Winder, and he was telling us about this building that blew up, and he was telling about they was hiring people out at the Savannah River Plant, and they start off paying you real good. Everybody I graduated

with—there were sixty in my graduating class— they was either going to Atlanta and going to work or they was going to college. And my parents couldn't afford to send me to college, and I was going to have to go to work. I didn't want to go to Atlanta, so I said, *"Well, I'll go there and put my application in."* So I came back to town with him one day, and went out there and put an application in. I was 17.

The man that interviewed me said, *"Well, Well, Miss Wood, you have to be 18 to go to work here."* And so I wouldn't be 18 for about six months—well, not that long, a few months. *"Well, you come back when you turn 18."* I said, *"Okay."* And so I went back home, and I was living with my grandmother at the time, and I told her—I said, *"I want to go back to [Aiken]."* I said, *"That's a long way from here."* Back then, that was 140 miles.

I said, *"That's a long way from here. I don't know if I want to go back or not."* But they called me and wanted me to come back, so I went back out there, and they said, *"Do you want to work"*—I said, *"I don't want to work in clerical. I don't want to do secretarial work."* I took typing in high school and shorthand and all that. I didn't like it. I said, *"I don't want clerical."* And they said, *"Well, we're hiring people in the lab, and they're making a lot more money than clerical."* And I said, *"Well, that sounds good."* I said, *"I took chemistry in high school, but I didn't make real good."* *"That's all right. That's all right. We'll train you."*

And so then I was staying with my uncle, and I told him—I said, *"Well, they want me"*—I told him[my uncle]—I said, *"Well, I got to go back and give two weeks' notice where I'm working,"* but I didn't have to. I just told them [SRP] that because I said, *"Well, I want to think about it some more."* So I went back home, and in two weeks I come back, and when I come back, my uncle told me—he says, *"Now, whatever you do, don't let them send you to 400 Area."* He said, *"That place has got the awfulest [smell] up there"*—in the meantime, he had gone to work out there in automotive. He was working in automotive. And he says, *"Whatever you do, don't let them send you to 400 Area. That's the awfulest place down there you have seen, and that place smells terrible. It's got gas" [hydrogen sulfide]—and I can't think of the name of it right now.*

Yes. It was awful. So as soon as I got to the employment office, they said, *"Well, we got a shuttle that's going to take you to 400 Area."* What am I getting myself into? And I had taken my lunch with me, and I was so nervous, I couldn't eat my lunch, and it was in a little bag, and I took it, and I put it in the trashcan, and I sat there, and I sat there, and I got so hungry—and I went and got it out of the trashcan. I went on to the trashcan to get it out.

I'll never forget that. But I ate my lunch and then the shuttle finally come and took me down to the area, and they introduced me to the supervisors down there and everything. I was 18 years old. I was so green. And all the supervisors was white. I guess they was probably in their early thirties or something, but you're 18 years old, you know—they was older. They was a lot older. And was saying, *"Yes, sir," "No, sir," "Yes, sir."* And they was Yankees, and they weren't used to that, and they kept saying, *"You don't have to say, 'Yes, sir' to me."* But I couldn't help it because it was the way I was raised, because I remember they kept saying—they'd look at me so funny and they'd tell me something, and I'd say, *"Yes, sir," "No, sir,"* you know? Anyway, they showed me around the lab and told me—you know. And so they assigned me to this one girl. Well, first of all they put me on shifts. I worked on days for a little while, just showing me around the labs and everything. Well, this [772-D]

was the only lab that was built then. It was the only one they had completed, [it] was where the heavy water [was made]

And so the girl they assigned me to was on shifts, but she was on days that week I came in, and her name was Betty [Grimsfield?], and she's still Betty Grimsfield, and she lives in Augusta, and I still keep in touch with her. That's been fifty years ago.

And anyway, all I did—she was supposed to be training me in this lab, to do this analysis, but all I did all day for four days was wash up her dirty glassware for her. But I didn't know any better.

And so I'd go in there and I'd wash glassware, wash glassware. That's all I did for four days was wash the glassware. It was a lot of glass and beakers, and that's all I did for four days. And then after, they put me on shifts, and they put me with some people that trained me to do the different analysis in the different labs, and I realized, *"Well, she didn't teach me anything; I just washed glassware for four days."* I don't know why I remember little things like that.

And I had some real good supervisors. The first night that I had to work midnight, I had never been up all night.

[I lived in New Ellenton] in a trailer park. ... It was not far from [Johnson's Crossroads?]. It was after the school.

And I got a ride to work, and I came in—the first night I had to go to work, I felt so bad, and I thought, *"Well, now, I hope I'm going to be all right."* I've never stayed up all night before, and I was so worried about it, and I felt so bad, and I got to work, and I got to feel worse and worse, and I went to the bathroom, and I threw up—on my first night, midnight. And I went in there, and I told my supervisor I couldn't hardly hold my head up, and I felt so bad because I hadn't been there for about two weeks, and I told my supervisor—I said, *"I think I'm sick."* And he felt on me, and I was burning up with a fever. Well, they sent me to medical, and they took my temperature and everything, and they called somebody to come take me home, and I had the flu. And I was in the bed for, like, four days, and I thought, *"Well, they're going to fire me."*

The first week I was on shift work, and I got sick. But they was real nice to me, and I won't never forget that. And if I had my friend here with me, Betty Johnson then, but she's Betty Waters now, she and I made it, and we were both 18. Now, she can tell you the name of all of our supervisors we had then. I can't remember them right now, but she does. I remember one was "Al" Hungerford.

Well, there was three shifts: A, B, and C, and they put us on B shift. Well, it [the shifts] was rotating. We worked days a week, and then you'd be off a couple of days, and then you'd work [unintelligible] for a week, and you'd be out two days, and then you start midnights, and you start midnights on Friday night and you work till the next Friday morning, and then you'd have four days off.

Oh, we had a ball. We had a ball. It wasn't anybody married or anything yet. Everybody on the shift was single. And there was about four or five women and about thirty men.



“OH WE HAD A BALL...”

(Above) Wheelbarrow race at Recreation Association picnic at Pecan Grove Park, circa 1950. Source: SRP Scrapbook “Early 1950.” (Below) SRP Baseball Team Forming. Source: SRP Scrapbook “Early 1950.” (Left) Mrs. Mary Walton and Charles Smith at a gala at Richmond Hotel. Source: SRP Scrapbook “Early 1950.” (Oval Inset) Elden Jones and his Hard Hat Band. Source: SRP Scrapbook “Early 1950.”



Six Area Baseball Teams Begin League Play Aug. 10

A six-team Savannah River Project baseball league was formed at a meeting of team managers July 23.

The first game will be played at 2:15 p. m. Aug. 10, and each will play five games in the "new" softball league.

The opening schedule is: 195-B vs. 195-A; Pecan Grove Park vs. Central State; Mountain View vs. Central State; Mountain View vs. Central State; Mountain View vs. Central State.

However, in the event an area does not have a team, it may play with one of the other squads.

No one may transfer from one team to another after the group is organized. In case a team is transferred from its regular area to another he will continue playing with his original team.

Central Recreation was provided uniforms, bats, balls, and catcher's equipment for the games. Each individual recreational organization will provide uniforms for its own team.

Once after playing in three games should contact Frank White, Recreation supervisor, immediately at Box 217 or TUC-2.



And in production, over in the canyon, it was all men. It was like 200 men worked over in the canyon in production, and they'd bring samples over to the lab, and there was, like, five women in the lab. Well, they knew all the women. And they was always, "Hey, Elsie. Hey, Elsie." And I didn't know any of them. And then later on, a lot later on, you know, like thirty years later, "I remember when you worked in F Area, and you were so snotty and you wouldn't speak to us." But the reason I wouldn't—is because these men would come over there and flirt with us and ask us out, and they were married men. Some of them were married, and, you know, at first I was just real friendly with them, and—: And then they'd ask you to go out, and then later on I find out they were married. And so I quit [unintelligible] some of them, and they said, "*I remember when you worked in F Area and you wouldn't even speak to me,*" and I thought, "*Yeah.*"

But anyway, we had a softball team—And we'd get off from work—we'd get off work sometimes off the graveyard [shift] at eight o'clock in the morning and go somewhere and play softball, and then sometime we'd go home and we'd go to bed and we'd get up at two o'clock and go somewhere and go swimming. And I remember a few times that we'd get off from work at eight o'clock on Friday morning, off a midnight [shift], and go to the beach, and I'd be up all day and, you know, never go to bed. And we'd get off a midnight, and we'd have—well, it's really five days if you count the Friday. We wouldn't have to go back until the next Wednesday on the four to twelve. I either go home with Betty, to her home in Tennessee, and we'd drive all day that first day we was off of work, or she'd go to my home and we'd spend two or three days and go back and just do things like that. And we'd get off of work sometime after four to twelve shift, we'd get off work at twelve o'clock, and on Whiskey Road, where Wal-Mart is now—well, before Wal-Mart was there, it was Palmetto Nursery. Before Palmetto Nursery there was the restaurant there called the Wagon Wheel, and the two big trees that's out there now were still there then. And we'd go to the Wagon Wheel after we'd get off work on four to twelve, and we'd eat and drink coffee for two or three hours, and then go home and go to bed. And we'd get up the next morning and go somewhere and go play softball or go swimming or something before we went to work that afternoon at four.—it was just like that all the time. And we had a great group of people we hung out with.

Anyway, we worked in 400 Area for a year, and then they told us about they was building this laboratory in F Area, and it was going to be real big and that's where they was going to have a radiation [room?]. They call them hot samples. They wanted to know if we wanted to transfer up there, and we could probably get a day job. And we said, "*Sure.*" We transferred up to F Area. Got there, and they were still doing construction work on the building. It was next to the canyon, that lab right next to the F Canyon.

Well, I met my husband out there. And Betty, the one I was talking about—she met her husband out there. Well, she's from Tennessee. She's from a little town called Lake City, which was near Oak Ridge, and that's how she found out about it because her aunt and uncle worked in Oak Ridge, and they transferred from Oak Ridge to here, and she came with them when she finished high school. That's how she came to work here. And her husband she met was from Johnston, South Carolina. He was working out there. [My husband] He was from a little town in Georgia. He went to college first [and then came to SRP].

And we did that [worked in F Area] for well up until I got pregnant, and that was when they said—"*you know, you had to lay back to three months.*" Yes. They made you leave at three months. It didn't matter where you worked.

And I was working in radiation, and that was before they had the lead-lined aprons that they let you wear when you do real hot samples, but the three months that I worked was the most critical in pregnancy, and that's when I had to work with some of the hottest samples that come through the lab, and then I had to leave after three months. And then after my babies was born, they said, "Well, we're not hiring women back in the lab anymore. You can't go back to work out there in the lab." And they offered me a clerical job, and I said, "No, no thank you." And then after they told me this, about a year later they called me to come back to the lab, and that's when I went back, and it was just like time had stood still.

I'll never forget it. It was just really weird how here sit the same patrolman. "Hey, Elsie." Went in and got to the lab. Same supervisor sitting in the same office. "Hey, Elsie." Well, all together I was in F Area for seventeen years. And all together, when I retired in '95 I had thirty-five years. I spent it all in the lab.

FIRST OFF, I AM, OR WAS, A CHEMICAL ENGINEER... (WILLIAM P. BEBBINGTON)

I got a bachelor's degree in chemistry from Cornell in 1936 and a Ph.D. in chemical engineering in 1940 [also from] Cornell. I came here [SRP] in 1952. You see, when we [Bebbington Family] got here, there were very few places to rent, live, or buy. It was almost all new buildings. When I first got to Aiken, that was one of the things I had to do [find a place to live] ... I knew there was not anything to buy. And, so I found that two men, Bob Lance and Art Morrey, who were Hanford alumni, had found a strip of land over off Whiskey Road, just beyond Palmetto Golf Course, and had divided this into six acre and a half lots, and each of them had taken one. And I don't know whether it was Lance or Morrey that I got talking with, but we went out and looked at it, and we decided that number 905 would suit us just fine. We bought the lot. At that time, it was just a wooded area. As it turned out, it developed into a very interesting community, very pleasant. We had a very pleasant life there.

We have to go back a little bit [in time], and I won't go much into this, but the basic design [heavy water research] was done at Columbia University where Harold Urey was the discoverer of heavy hydrogen. One of the things that everybody wanted to do was figure out a way to separate - I think there's only 7 parts in 100 of deuterium in overall hydrogen mixture, and that's true in water too. So the goal was to find out a process to separate it. Well, there are fairly simple ones. Electrolysis probably gave the best separation, but it was hard to do that on a large scale. And distillation was one and could be done on a very large scale - but the separation factor wasn't very good. In other words, there's not much difference in the volatility between D_2O and H_2O . So, then, Urey's people discovered that by exchange of deuterium between water and hydrogen sulfide gas, working counter-currently in what's known as scrubber towers, you got a pretty good separation. But it had to be done under considerable pressure. I've forgotten, probably 300 or 400 pounds per square inch. That was brand new. Well, a graduate student under Harold Urey, Jerry Spevack, had developed, under Urey's direction, this process. He designed a pilot plant, and that pilot plant was the first thing to be built at Dana, which was an ordinance plant making explosives- one of several.

So, then at the same time, Du Pont had gotten into the act and decided— it had been decided, that the reactors at Savannah River would be heavy water-moderated. There were lots of advantages over graphite for that, which was used at Hanford. Of course, you get a lot of that in the book [Bebbington's "History of Du Pont at the Savannah River Plant"]. So, I'd had experience— I started with DuPont at the Bell Works in West Virginia and had useful background from there and also from my college work, so it was logical. It was a chemical engineering problem. So, I got sent to that. Well, in the meantime, the AEC had contracted with Girdler Corporation to design and build a production heavy water plant at Dana. So, I got involved with the Girdler engineers, in fact, I even spent a week or two in Louisville working with them on the calculations for the plant. I think I must have been about 35 [when I was at Dana]. And Bill [Morris] was close to the same age.

Before Dana was even complete, it was decided because of the size of the Savannah River project and reactors, that we would have to have more than one heavy water plant. So then Du Pont went ahead and designed a plant... And they immediately, having designed one for Dana, they decided where they could make the other two somewhat better, and so on. But they all went up, essentially together.

See, that was the advantage that the AEC had wanted from getting Du Pont. They did have this broad capability of bringing a whole mess of people in all at once and doing it. Again, I was involved with the chemical engineering calculations of the separations thing but not with the design of the plant itself. That was the engineering department people primarily.

I was sent there in 1952 to be in charge of the Works Technical Department section that provided technical support for the production department. We helped write the operating manuals and technical manuals, and my staff worked right in the manufacturing buildings with the production staff. They observed, advised, and so forth. There was a standard operating practice for Du Pont, to set up such.



Night time view of 400/D Area , circa 1953. Courtesy of SRS Archives, negative 3391-003.

First place, let me say that with the so-called GS process, which was the H₂S exchange process– and GS, incidentally, is not “Gerry Spevack,” it’s Girdler-Sulfide. And that only went to, I guess, somewhere between 5 and 10 percent of the D₂O in the mixture. And then after that, it went to water distillation, which was called DW, for “Du Pont water,” to go up to above 90 percent. And then finally electrolytic, or E, to take it all the way to essentially 100 percent D₂O. Very close to it. Here’s some. See how heavy it is?

I don’t know if there would be any subtle biological effects or not [in the everyday use of heavy water]. But as far as the human body or any other– you could grow plants with it or anything else. Chemically, there’s no difference. See, if there were any chemical difference, it would not have been so damned hard to separate it.

Du Pont got involved, of course, because they had run Hanford. And the government came begging for them to do it. See, when they through with Hanford, they said (rubs hands together): “*No more of that.*” It wasn’t in their line of business, you see. But then they came back again and begged them.

There were several [concerns with the GS process]. It was a high-pressure process. H₂S water is corrosive. Control of the process had to be very careful. The ratio of water flow down, to H₂S flow up, had to be carefully controlled. There was no simple way to analyze it. You couldn’t pour a reagent in and do it like in the laboratory. For the most part, you had to use mass spectrometers to measure concentrations. So all those were stiff problems. We relied a great deal on the engineering department and their staff of metallurgists, and so forth. We did a variety of things – used stainless steel whenever we could. Some of the towers were just plain carbon steel, but the plates were stainless steel. So that was the way they did that. There wasn’t any inhibitor that you could put in to take care of it.

H₂S is highly toxic. Fortunately, you can smell it. However, if you smell a little bit of it, your nose is quickly numbed to smelling an increased concentration of it. So we had quite elaborate system. First place, there was something like a roll of litmus paper, which would turn black if there was H₂S in the air. And you always used those. But no person ever went alone into that area. You always used a buddy system. You didn’t go side by side, because then if you got into gas, you both get it. So the two buddies stay ten or fifteen feet apart so that if one was knocked down, the other could sound an alarm. The result was that we never had a serious injury or fatality from hydrogen sulfide gas.

As the book says, that was a very safe plant. Any injuries we had in that D Area was other things. We even had a couple of men killed, but they were killed by being scalded by hot water when they opened the pipe and it gushed out at them. One of them fell off a scaffold and was hurt, things like that. Not really process-related.

Fred Endorf was my opposite number as the production manager for heavy water. Under him, he had, I can’t remember their names off-hand – one man was in charge of GS, one in charge of part of the E plant was my daughter’s father-in-law (laughs), Warren Long. And then, I’ve forgotten who was in charge of the distillation plant now.

The Canadians went the other way [Unlike the United States, Canada uses heavy water in their nuclear reactors]. They had the biggest heavy water plants that have ever been built, far bigger than D Area. I think they probably

came to the same conclusion that we did when we built the Savannah River Plant and decided to use heavy water-moderated reactors instead of the old graphite piles. This is out of my area, but there were both advantages from the nuclear end, and from the engineering end.

Now, I'll give you a little side-trip here. Back in the time when we were first going into the business, I was sent over to France and Germany to talk with the people there who had heavy water separation plants. And that was kind of interesting. They did – I think, I can't remember, neither of them was using the H₂S exchange process. I think they both may have been using water distillation followed by electrolysis. But of course, the French word for heavy water is "l'eau lourde" and that was kind of an apt thing.

But the Germans, that was even better. I asked one of their engineers, and of course, they all speak English fluently. I think they sent me there because I spoke a little bit of French and German, but I didn't have to use any of it except ordering food in restaurants and things like that. But in Germany, they referred to the plant as – in France, it was done by "L'électricité du France" – in Germany it was done by a dye company, "Farbwerke Hoechst," and they referred to the heavy water plant as their "Millionen Grab" – "grave of millions" – of marks.

THE BUDDY SYSTEM, PROCEDURES AND AQUA (MITCH BURGESS)

I was a chemical engineer and mostly I processed control work for chemical engineers, and I think my working with DuPont either there [SRS], or the commercial plant before I came there, was a very lucky decision because when I left school there was a great demand for chemical engineers, and you could have had a choice of about 10 jobs. And just by luck I picked DuPont.

I was working for the Film Department in Iowa for DuPont. The Plant, like other plants, was giving a quota of the number of the people that they needed to do these jobs. That was in 1952. I was checked out by the FBI and then transferred down here in July of 1952 in construction-checking first, then was assigned as a process supervisor over technical people, other engineers. [I] began at the plant in July of 1952 and worked 17 years in the 400 Area.

Well, a lot of the people [at SRP] came from Dana. They transferred to 400 Area – and 400 area and then the laboratory, SRL [Savannah River Laboratory]. The [GS] process was a standard process and we knew that the process worked, but the pilot plant at Dana failed because it choked up with iron sulfide. They had a small pilot plant, you know like a standard pilot plant. So we started the Dana Plant and we started the 400 Area plant. But other than that, it was the Pilot Plant. There were great sighs of relief when the concentration of heavy water started integration. Yeah. It was too late [to go forward with a pilot plant]. If you recall, there was a great deal of pressure by the administration, by the United States Administration, to move forward with this because it was Cold War conditions. They [had] made some of it [heavy water] at the Manhattan Project, but that was before my time too. When I saw the plant on the Manhattan Plant, it was rusted and it was shut down long since. It was a pure distillation process.

Gas [was the main concern in the 400 Area]. H_2S gas. Not radiation. If you could smell it, it was all right. If you couldn't smell it, boy, you'd better run! Because H_2S deadens the nose above 2 percent, as soon as the gas gets above 2 percent, you'd no longer smell it.

Well, we had a couple of guys collapse because they couldn't smell it. But we had the "buddy system," and no one had any permanent injury. You had to have a buddy when you went into the GS area. There were several cases where the buddy went down and the "buddy system" worked because they turned in alarms and somebody came up, picked him up, carried him to a corridor and the guy recovered right away. Very rare-[ly happened]; so rare that any time one happened it was a big thing. There'd be a big announcement.



Man on stretcher using Scott Air Pack for drill. Courtesy of SRS Archives, negative 1498-003.

[Security] was very tight. During the first days, all of the data was secret and we used a classified notebook to do calculations and everything, so it was tight. There was a perimeter fence around the whole area, of the 400 Area, and then a barricade around the GS tank, the storage tanks where our liquefied hydrogen was.

Well, [in a typical day] you'd come to work in the morning; we went home at 4 o'clock. We'd eat at noon. In the meantime we worked out calculations or procedures. A great deal of work went into procedures. Written procedures [on how to do something safely], and the way to do it successfully.

We'd do the procedure. We would do, there were different things that we had to do and we'd read each of the items very carefully and as a work assessor, we would review all of the procedures, every one in detail, and the production people would review them in detail. The Health/Physics people would review them in detail. Then finally, we had to approve what the guys did. This is a [one example] for instance: the H_2S stripper, which took the heavy water, you know the light water that was waste went to the stripper and the H_2S was stripped off. So then, when it went eventually to the outfall, the water was well stripped from the GS units. Then the wastewater went over a number of dams so that the waste water did an additional stripping, and they sampled the river up and down regularly.

They had one fire, as you know. I forgot what the date was. But two of the 16-inch pipes that were joined with a screw nut. We pulled the two of them together and they didn't separate. Over time it stretched a little. Every time it would shut down, we had to tie it up. It did stretch a little and by the time they opened it, that flame went something like 400 feet in the air. No one was hurt. That's where our check sheets and procedures came in. There was a guy named Tally Crocker who was— I don't know if Tally is still alive. I've lost touch with him entirely. But he was the main fighter in that fire. He stood right up there and faced that fire and gave people equipment and directions, and when the thing was over, one of the operators asked him if he wasn't scared, and by then the realization of what he had done had set in. He told him he sure as hell was scared.

[The GS] Process control was a problem, because you were very subject to the liquid-to-gas ratio in the tower and I'm surprised that the guys did as well to start up. We didn't have any way of telling the production [about adjustments] because by the time we'd run the final process it was way too late to make any daily adjustments. We finally developed a computer for our system to calculate the production rate when you wanted to do that. It was called A-Q-U-A, "Aqua." Bill Bebbington had a little chart on his desk that showed the L/G [liquid-to-gas] versus production rate. They were like a curve like that. The second series were the other direction; so we had both curves and he melded them together to find out the maximum rate. We used that to calculate the production rate, and used it for process control. We could run that program at about 10 minutes. Probably about 10 seconds an hour later. Gee, I think [the AQUA computer came in], certainly in the 1960's or 70's. I wrote a paper on this thing, and there's a paper in the AIChE Journal.

IMPROVING THE PROCESS (RICHARD SHULKO)

I worked in the 400 Area for four years, from 1953 to 1957. [I came] right from school from Clarkston University, now the University of. It was a college when I went there, in New York State. I was born in 1930 in Binghamton, New York.

Well it was concentrating deuterium oxide from normal Savannah River water to reactor-grade material [heavy water] which was about 99 percent plus pure, and it used hydrogen sulfide as the carrier. I didn't work in the GS Process; mainly I was in the finishing of the electrolytic plant, which brought it up to I guess about 20 or 30 percent. The towers, the hydrogen sulfide process was in towers and there were three buildings, and then they shipped the material to the distillation, and then when, I forgot exactly what percentage it got up to with distillation, probably about 85 or 90, and then....Well, the distillation was similar— small towers— and then the electrolytic, that was the building with the electrolysis. You didn't want to go in there with a watch.

We were operating three shifts, seven days a week. Everybody had canisters and little indicators, particularly if you went out to the units. And your nose was the first indication, because it smells like rotten eggs. Now if you smelled that, and then you didn't smell it, you were not sure you were safe because it paralyzes it [the olfactory sense] and you could be in real deep trouble. DuPont, I would have to say, is one of the safest in the industry, in

both chemical and nuclear safety. We had the buddy system, where if you went out in the units, you went in pairs, and you had an emergency— I think it was 10 minute— air bottle [Scott Pak] with you.

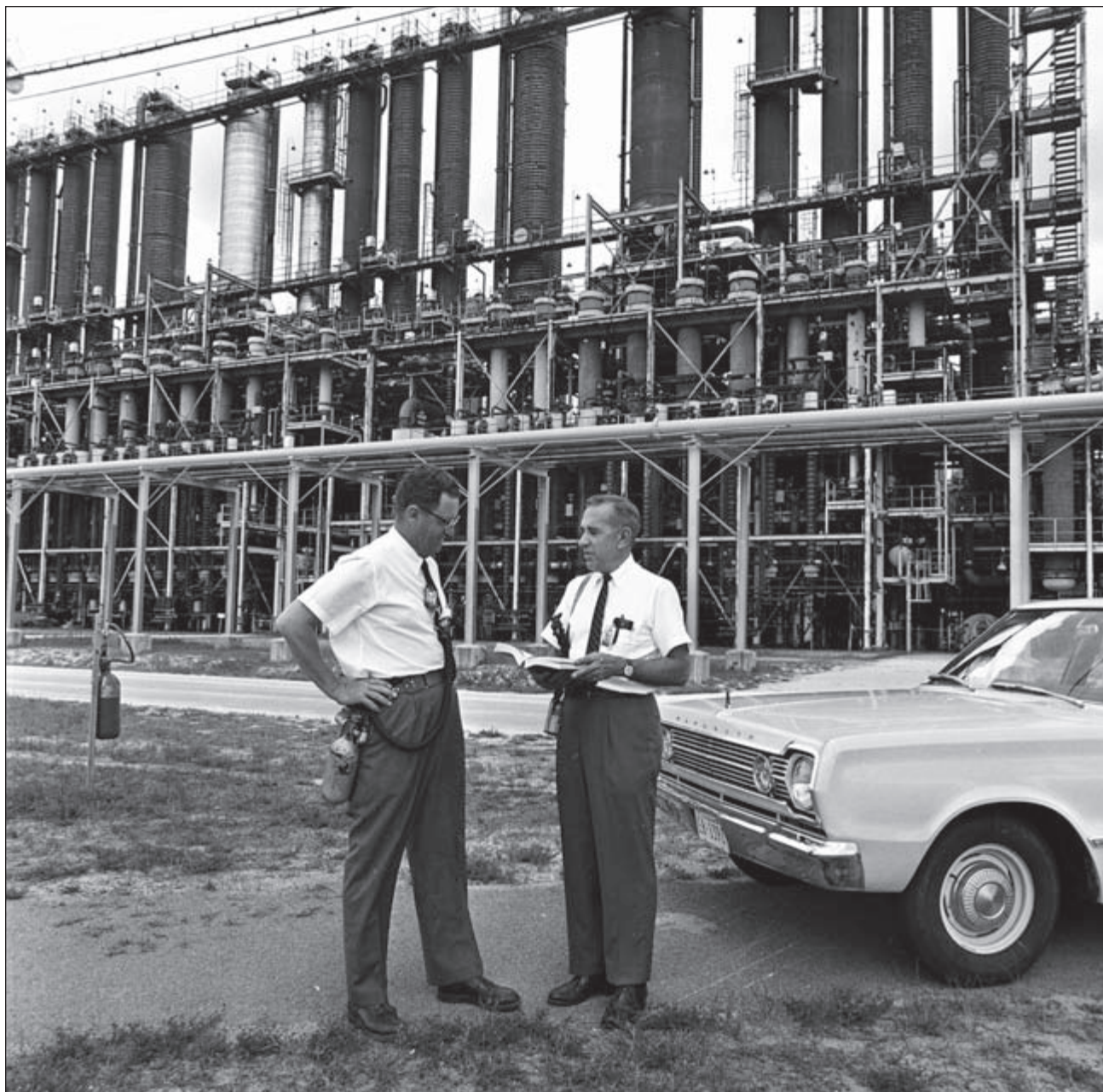

The buddy system at work. Courtesy of SRS Archives, negative 11328-010.

I was in Technical Support. I had a lot of interface with the [lab], but they wouldn't let me get into the chemicals, although I was a chemical engineer. Well [on a typical day], first thing, you'd go read the overnight logs to see if they had any problems. Then if they had some [problem], that was your first concern, try to solve what was going on. You'd have meetings, you know, to try and solve the problems. Then you'd try to improve the process. One of my last things was try to see if we could expand the usage of the—to eliminate the concentration with the evaporation and shut that down to improve the processes. Such projects like that.

Well, like I said, if someone had a problem, if they had to go and read some things in the columns, I would act as their buddy quite often, and also learn, you know, where to go there as well. A funny thing, I had a little bit of vertigo, and going up the columns [they] were a couple of hundred feet high. The walkways, some of them were concrete and I didn't have any problems there; but it was the ones that had the grating, that you could look down straight through. And actually, they were safer than the concrete, because they tended to corrode and some of them fell. But no one was ever hurt. When they had the first one [fall], they started to have extensive inspections.

Sometimes you have to take readings up there, ...you know we had a big flare tower that was 400 feet. There were inspections, I think. It wasn't often. I think once every two years or something. You had to take a special physical because it was a long climb up there.

It [the flare tower] was for an emergency. If you had a great leak, you had to flare it, you know? Burn it immediately. Because it [hydrogen sulfide] was heavier than air so it tended to go to the ground level. You'd have pumps and things and gaskets- set you up- and then when we had a general maintenance, you had to evacuate all the H₂S, put it in the flare or put some back in storage.

Well, this experience coming out of school where that [working in 400 Area] was the closest experience for a chemical engineer- where reactors it's totally different. Personally, it was a good experience for me because it was things that you studied in school, distillation and H₂S, but fortunately Du Pont- I don't think they had any other processes like that- was very used to working with hazardous materials.

YOUR JOB DEPENDED ON IT (LEE POE)

My name is Lee Poe, William Lee Poe, Jr., and I worked at the Savannah River Site for many years in the Works Technical Department, which is the Plant Assistance Department. When I began at the Plant was October 1, 1953. That day is clear in my mind; but I had worked before at Dana. Talking about heavy water, that was the other heavy water plant, and I think that I worked at Dana from June of '53 through September of '53. I went there for a start-up program process.

Before I went to Dana I was in Oak Ridge training to come to Savannah River Site in Separations. Because of the start-up needs, they transferred me up to Dana to help get those heavy water units started up, and then came down here to start up these heavy water units. Dana was a war facility that had been built for another purpose and they took it on and converted it into a heavy water plant, because they could get it up quicker. You know back in that time, you were racing against the clock and you had to use whatever facilities around the country that you could.

When I first got here, they were in the process of constructing and starting up the units. Looking in Bill Bebbington's report, "The History of DuPont at Savannah River Plant," and what I see is that Dana started up on August 8, 1952, and the first unit at SRP was complete and began start up at October of 1952 with all of it being completed

in May of 1953. So I was here during that start up period, and also performed some of the construction checking responsibilities.

[The GS process] is a hydrogen sulfide process and what you are doing is the deuterium extracts into hydrogen sulfide, depending on the temperature. So what they did, they rendered a cold system through a series of cold towers and extracted it into the hydrogen sulfide and then re-extracted it in the Hot Towers. I believe I've got that correct. It may not be, but you might want to look it, the details and see, I haven't thought about that for a while.

And they ran up to about 87% deuterium oxide in the heavy water and then it went over to the distillation process where they carried it on up to, I think it was, 92 or 93 percent or something like that. Then they put it in electrolysis to finish it off, and make specifications. The specifications were pretty high and I better hold up on what the concentration was because I don't know if it was classified or not.

The thing that was important was that you had to use all three processes. The GS Process was large bubble-cap trays and columns. The columns were 10 feet in diameter and they were heated of course to get the H₂S at the right temperature. It was really a distillation process in that you were using trays inside these columns that had bubble caps on them and there were a number of trays— I don't have any idea the number. But I do remember crawling up inside the towers and crawling up through two or three trays to check on some of the bubble caps at one time. You know, hydrogen sulfide is very toxic; so you have to be sure that the concentration of hydrogen sulfide is low enough that it's not a problem to health when you do those kinds of things. In the 400 Area when we were working the GS we always carried a Scott Air Pack in case there was a release. I never had to use it, I don't think, but it was just part of the safety system we had.

Anytime you are doing large, high temperature, insulated towers you've got thermal problems. But I would think that the gas problem was more acute. A "bubble cap" is a—well, what you do is you perforate a tray and then put, like, a mushroom on it and it comes up through there and bubbles out through the gas, through the slots in the riser. There is water that stands on top of it and it bubbles through that. Now, of course, the massive size of this was a thing that kept us all busy. We had to keep the towers and the blowers working so that if one went down, you had to shut the whole process down; and then you had to do that very carefully. So, you had to run the whole thing. The major difference between the Savannah River Plant and the Dana Plant was how these towers were configured. At Savannah River they were, I think there were eight units, independent units that you could operate. At Dana it was all one. You operated the whole system or none.

They were all build together [at SRP]; they were right side by side. You could keep seven running. Now you are pumping both water and hydrogen sulfide and so you've got to continue to make those things work. Since the hydrogen sulfide was toxic, you couldn't allow it to leak out. You had to work the system so that the seals in the pumps and blowers had an independent cavity that you fed water into so that the water would leak out rather than having the hydrogen sulfide leak out.

We extracted the deuterium from the natural water and concentrated it, until it was essentially pure, heavy water. And that, of course, was used in the SRS reactors.

Well, we looked at a whole bunch of different options for making heavy water while I was there and, you know, you can get it from power plant, distillation, processes and that sort of thing. But the most efficient was the GS process. Once you got it out and up to a reasonable concentration, the deuterium oxide boils at a little different temperature than the protium, which is hydrogen- protium oxide. They boil it a little so you can use this distillation process to separate them, but it takes a lot of equipment and a long time to get any real concentration.

They [personnel] were interchangeable and one operating group operated several units. So there wasn't one operating group for each unit. It was several had one and several had another. The point that I played was providing technical support to the manufacturing plant. So if they got into any problems we were supposed to help them get out of them.

The gas was the main thing. Well, I say that; always if you've got high temperatures you worry about burning someone or scalding people. It's such a big system, that you have to really be careful that when you shut down that everybody knows it and is out of the way so you can get ready to start up again. So you have to know where everybody is at that time; otherwise, you'll start it up with a person working on a unit and scald him to death. But that's small compared to the toxic issue. Then of course, in the electrolysis part of the process you could electrocute a person; you know, it was electrically operated cells that were doing the separation.

There was a powerhouse built for the 400 Area and it's still down there and there's still, right now SCE&G is operating it, as I understand it, for DOE.

We'd go over [to Cassels store in Ellenton] and buy stuff there. They had a continual- they had a sale that went on for years; a going-out-of-business sale. But the system wasn't like it is today, where you go off and spend an hour eating lunch. You had a certain period of time you had to be back and you actually didn't have the freedom and flexibility to go out of the area to eat. We ate at night there sometimes.

Well the production unit was on four shifts; operated a four-shift operation, 24 hours a day, seven days a week, and we were on days. Now, Dana had another problem. It's cold up there and you had to keep the steam traps working. So they had a big crew of people that went by with a big stick and just kept the steam traps [clean]- beat them, you know, to keep them operating. Because if they froze up, the unit would shut down, and steam traps had a notoriously high failure frequency. And at minus-10 [degrees]- for a southern boy, that's pretty cold!

The environment was different then than it is now. We were doing a war effort. Well, you came into the area and you had to go through security to get into the area. You had to wear badges, but I never was called on it, after you got inside the area. I know there was security because we saw them walking around. They were just being sure everything was safe, was secure, I guess, not safe, but secure. You had to have your clearance in order to get into the 400 Area. Well, they investigated everybody that came in with a Q clearance; and I guess they investigated everybody with an L clearance. There were a lot of them, so, there was a lot of clearances being granted. It took about four months to get the clearance.



Security check point, 400/D Area, circa 1952. Courtesy of SRS Archives, negative 2242-001.



Everybody went to work in carpools. Your carpool came by and picked you up and you rode out and then you left and went to work. You worked the morning and then you had lunch and then you'd work the afternoon and then you met your carpool on time to go back so you didn't inconvenience everybody else. Everybody kept to the schedule, so the carpools were a great opportunity. That meant you didn't have to take your wife's car, your car away from your wife. She had the car most of the week, all but one day, when you were driving, when you drove the carpool. We rotated drivers in the carpool. Most of us drove one day a week.

Carpooling usually was the start to a Typical Day in D Area, Courtesy of SRS Archives, negative 2243-013.

I think that you have to realize that we were young people at the time and working there, and the one thing that I remember was there were very few, or no, air conditioned offices or anything like that. I remember when I first went there and working in the 400 Area, I'd come from Alabama so I know about gnats. But the gnats were about

to drive the people from the North crazy because they were just all over you, and you could swat them away or shoo them off. There were a lot of bugs and other things down in that part that you had to put up with.

In the 400 Area, in the control room, on the evening shifts, we'd try to get out management to get us some insecticide so that we could spray the mosquitoes and get rid of them and the roaches and all that kind of stuff. But that wasn't very high on their list of priorities, so what we did was one night we killed them all and piled them up on the table on the desk in the control room so when the day shift came on they could see them. Boy, we caught the mischief over that. They didn't think that was necessary. It wasn't; we were just proving a point. Pretty soon after that we got DDT insecticide; anyway to make life a little more palatable.

I guess the other thing that stands out in my mind is there was an awful lot of safety for gas problems. Like I said, you were carrying a tank on your back, like a scuba tank, full of air so that you had a chance to get from wherever you were, if you were hurt, or if there was a leak out.

You had to put that on [Scott Air Pack] and there were a lot of emergency drills to get that on quickly and make sure it was working correctly. So there was a technique that we were using for that. It seemed to work quite well and as far as I can remember, nobody was ever killed from the gas. There were several people that were overcome and somebody had to help them— their buddy. We always worked as a buddy, a pair of us, so there was always somebody to pull you back if you needed to. Like I mentioned earlier, we had to inspect some of the towers internally because we found that if you put too much water on the tower it would crash down to the one below it and you had to go fix them and put them back up so that they— they were lighter gauge material and you could put enough head on them that you could knock them down. And so, we had to go in and inspect corrosion of those bubble caps and change out some of them. So, you know, you were in crawling through the bubble caps. It wasn't a very clean activity.

The other thing was, there was, in case of emergency, you can flare your tower; open up a valve and the gas would go about a 400-foot flare, a 400-foot tower, and burn at the top. We had to, occasionally, go up and check the igniter on the top of that tower. I remember that was really an interesting; some of us could do it, most could not climb that far up. Then there was a caged ladder, you know, going up, so you were in a cage, but you didn't want to fall either. So, we'd go up and check that igniter and replace it. But there were a number of events that had to take place in an operation like that to make the thing work. Nothing works the way you'd hoped it would work. There's always something that you learn, then you learn how to get around the problems.

The Electrolysis Plant, what you do is if you have a cell and you're running electricity through, and you're making hydrogen and oxygen. So there's always an explosion potential in a cell itself. Now these are small, but not tiny, what you are talking about. So you had to be sure that the gas system, vent system, works correctly.

DW Plant was where you took the heavy water and fed it into the plant through distillation process; concentrated the deuterium. It was a commercial plant. Why I think they located Dana where they did, was because that Plant was already there. Down here, I think we built it. Built the one to do it.

I said security was tight and it was. A lot of times the people in the GS Plant didn't know what the DW Plant was doing and visa versa. There just wasn't any need to talk about that. If there was no need, then it wasn't discussed. Your job depended on it.

CHAPTER II

1. Lenore Fine and Jesse A. Remington, *United States Army in World War II: The Technical Services. The Corps of Engineers: Construction in the United States* (Washington, DC: Center of Military History, 1989), 659.
2. Henry D. Smyth, *Atomic Energy for Military Purposes: the Official Report on the Development of the Atomic Bomb under the Auspices of the United States Government*. (Princeton, NJ: Princeton University Press, 1945).
3. Fine and Remington, *United States Army in World War II: The Technical Services*, 663.
4. Rodney P. Carlisle and Joan M. Zenzen, *Supplying the Nuclear Arsenal: American Production Reactors, 1942-1992* (Baltimore, MD: John Hopkins University Press, 1996), 11.
5. Fine and Remington, *United States Army in World War II: The Technical Services*, 650-651.
6. F. G. Gosling, *The Manhattan Project: Making the Atomic Bomb* (US Department of Energy, Washington, DC: Government Printing, 1994), 13-14.
7. Gosling, *The Manhattan Project*, 15-16; Richard Rhodes, *The Making of the Atomic Bomb* (New York: Simon and Schuster, 1995), 71.
8. Gosling, *The Manhattan Project*, 15-16.
9. Jon Jefferson, *Swords to Plowshares: A Short History of Oak Ridge National Laboratory*, edited by Sybill Wyatt and Cindy Robinson (Oak Ridge National Laboratory, Office of Public Affairs, US Department of Energy, Oak Ridge, TN: Government Printing Office, 1993), 3; Gosling, *The Manhattan Project*, 16.
10. Fine and Remington, *United States Army in World War II: The Technical Services*, 667; Gosling, *The Manhattan Project*, 23-25.
11. Oak Ridge National Laboratory, *Power and Flux: Neutron Science R&D at Oak Ridge National Laboratory* (Oak Ridge, TN: Office of Planning and Management, US Department of Energy, 1995).
12. Fine and Remington, *United States Army in World War II: The Technical Services*, 667; Gosling, *The Manhattan Project*, 667.
13. Dale F. Babcock, *Du Pont and Nuclear Energy An Address at Savannah River Laboratory*, E. I. Du Pont de Nemours and Company, Aiken, South Carolina, June 22, 1982," Manuscript, (Wilmington, DE: Hagley Museum, Series II, Box 7, Folder 2, 1982), 2.
14. *Time the Weekly Magazine*, "The Wizards of Wilmington," Volume LVII, No. 16, April 16, 1951, 95.
15. Smyth, *Atomic Energy for Military Purposes*, 110-111.
16. Carlisle and Zenzen, *Supplying the Nuclear Arsenal*, 37, 44.
17. Rhodes, *The Making of the Atomic Bomb*, 216.
18. Fine and Remington, *United States Army in World War II: The Technical Services*, 667; Gosling, *The Manhattan Project*, 687, 692.
19. Gosling, *The Manhattan Project*, 41-42.
20. Rhodes, *The Making of the Atomic Bomb*, 233-238.
21. Carlisle and Zenzen, *Supplying the Nuclear Arsenal*, 56; Rhodes, *The Making of the Atomic Bomb*, 283.
22. Richard G. Hewlett and Francis Duncan, *Atomic Shield, 1947/1952: A History of the United States Atomic Energy Commission Volume II 1947-1952* (Berkeley: University of California Press, 1990).
23. Carlisle and Zenzen, *Supplying the Nuclear Arsenal*, 66; Rhodes, *The Making of the Atomic Bomb*, 317-321.
24. Rhodes, *The Making of the Atomic Bomb*, 323.
25. Office of Environmental Management, U.S. Department of Energy, *Nuclear Age Timeline: Poster Supplement and Resource Guide*, 1994, 12; Rhodes, *The Making of the Atomic Bomb*, 210-211, 241.
26. Carlisle and Zenzen, *Supplying the Nuclear Arsenal*, 70.
27. Office of Environmental Management, U.S. Department of Energy, *Nuclear Age Timeline: Poster Supplement and Resource Guide*, 1994, 14-16.
28. *Ibid.*, 12-14.
29. David Albright, Frans Berkhout, and William Walker, *World Inventory of Plutonium and Highly Enriched Uranium*, (New York: Oxford University Press, 1993) 31-33; T.B. Cochran, *Nuclear Weapons Databook*, (Cambridge, Massachusetts: Ballinger Publishing Company, 1984), 6.

30. Carlisle and Zenzen, *Supplying the Nuclear Arsenal*, 96.
31. Engineering Department, E.I. Du Pont de Nemours and Company, *Savannah River Plant Construction History, Volumes I—IV*, (Wilmington, DE: E. I. Du Pont de Nemours and Company 1957b), 16-17.
32. *Ibid.*, 16, 18, 204.
33. Hewlett and Duncan, *Atomic Shield*, 428.
34. *Ibid.*, 430.
35. W. P. Bebbington, *History of Du Pont at the Savannah River Plant*, (Wilmington, DE: E. I. Du Pont de Nemours and Company, 1990), 2.
36. Engineering Department, E. I. Du Pont de Nemours and Company, *Savannah River Plant Construction History, Volumes I—IV*, (Wilmington, DE: E. I. Du Pont de Nemours and Company 1957b), 17-18.
37. R. M. Evans, Letter to Walter J. Williams, Director of Production, Atomic Energy Commission, Washington, D.C., from R. M. Evans, Assistant General Manager, E. I. Du Pont de Nemours and Company, Wilmington, Delaware, August 28, 1950.
38. Atomic Energy Commission and E. I. Du Pont de Nemours and Company, (Wilmington, DE: E. I. Du Pont de Nemours and Company, 1950).
39. Crawford H. Greenewalt, Letter to Stockholders of E. I. Du Pont de Nemours and Company, October 18, 1950, (Wilmington, DE: E. I. Du Pont de Nemours and Company, 1950).
40. Carlisle and Zenzen, *Supplying the Nuclear Arsenal*, 19.
41. H. C. Benhardt, *DPSTM-100, 100-Area Technical Manual Unclassified Version*, (Aiken, SC: Savannah River Laboratory, 1988), 101.
42. E. I. Du Pont de Nemours & Co., *Occupational Safety and Health: A Du Pont Company View*, (Wilmington, DE: Savannah River Plant Engineering and Design History, Volume II, 100-R, P, L, K, and C Areas, 1957), 26.
43. Hewlett and Duncan, *Atomic Shield*, 531.
44. C. H. Topping, *Plant 124-Site Survey* (Wilmington, DE: E.I. Du Pont de Nemours & Co., 1950), 1-3.
45. Engineering Department, E.I. Du Pont de Nemours, *Savannah River Plant Construction History, Volumes I—IV*, (Wilmington, DE: E. I. Du Pont de Nemours and Company, 1957b), 32.
46. *Ibid.*, 16.
47. Topping, *Plant 124-Site Survey*.
48. Newspaper of the Savannah River Project, Feb 29, 1952:5.
49. Engineering Department, E.I. Du Pont de Nemours, *Savannah River Plant Construction History, Volumes I—IV*, (Wilmington, DE: E. I. Du Pont de Nemours and Company, 1957b), 42.
50. Richard Rhodes, *The Making of the Atomic Bomb*, 618-619.
51. Thomas Fetters, *Logging Railroads of South Carolina*, (Illinois: Heimburger House Publishing Company, 1990), 210.
52. Engineering Department, E. I. Du Pont de Nemours, *Savannah River Plant Construction History, Volumes I—IV*, (Wilmington, DE: E. I. Du Pont de Nemours and Company, 1957a), Vol. I, 23-24.
53. *Ibid.*, 23-39.
54. *Ibid.*, 35.
55. Engineering Department, E. I. Du Pont de Nemours, *Savannah River Plant Construction History, Volumes I—IV*, (Wilmington, DE: E. I. Du Pont de Nemours and Company 1957a), Vol. II, 408.
56. American Machine and Foundry Company, *Savannah River Plant Engineering and Design History, Volume I* (New York: American Machine and Foundry, 1954), 8.
57. The Lummus Company, *Savannah River Plant Engineering and Design History* (New York: The Lummus Company, 1954).
58. Engineering Department, E. I. Du Pont de Nemours and Company, *SRP Engineering and Design History, Volume II*, 55.
59. *Architectural Forum*, "Voorhees Walker Foley & Smith Have Become Architects to Industry," November, 1954, 140.
60. Carlisle and Zenzen, *Supplying the Nuclear Arsenal*, 87-88.
61. New York Shipbuilding Corporation, *History Project 8980 - NYX* (Camden, NJ: New York Shipbuilding, 1954).

62. Carlisle and Zenzen, *Supplying the Nuclear Arsenal*, 77.
63. *Ibid.*, 77.
64. *Ibid.*
65. J. Brotherton and M. W. Lower, *Savannah River Plant External Affairs Fact Book*, (Aiken, SC: E. I. Du Pont de Nemours and Company, Savannah River Plant 1988), 1.
66. Bebbington, *History of Du Pont at the Savannah River Plant*, 11, 22.
67. *Ibid.*, 46, 73.
68. *Ibid.*, 46.
69. *Ibid.*, 47, 71.
70. *Ibid.*, 70-71, 226; USDOE Office of Environmental Management, 158.
71. Bebbington, *History of Du Pont at the Savannah River Plant*, 49-51.
72. *Ibid.*, 66-67.
73. *Ibid.*, 68-69.
74. *Ibid.*, 81-82, 87.
75. *Ibid.*, 52-53.
76. *Ibid.*, 52.
77. *Ibid.*, 71.
78. *Ibid.*, 71-72.
79. *Ibid.*, 72-73, 112-113; USDOE Office of Environmental Management, 177.
80. Engineering Department, E. I. Du Pont de Nemours and Company, *Savannah River Plant Engineering and Design History, Volume I, Administration*, (Wilmington, DE: E. I. Du Pont de Nemours, 1957b), 253; Engineering Department, E. I. Du Pont de Nemours and Company, *Savannah River Plant Construction History, Volumes I—IV*, (Wilmington, DE: E. I. Du Pont de Nemours, 1957d), 339, 346.
81. Bebbington, *History of Du Pont at the Savannah River Plant*, 112, 130; Engineering Department, E. I. Du Pont de Nemours and Company 1957d, 338-339, 350.
82. Bebbington, *History of Du Pont at the Savannah River Plant*, 130-132; J. E. Haywood and T.H. Killian, "Overview of Savannah River Plant Waste Management Operations" in *Waste Management '87: Waste Isolation in the U.S. Technical Programs and Public Education, Volume 2*, (Tucson, AZ: Conference Proceedings of the Symposium on Waste Management, 1987), 51.
83. Bebbington, *History of Du Pont at the Savannah River Plant*, 146; Engineering Department, E. I. Du Pont de Nemours and Company 1957e, 442; W. L. Marter "Ground Waste Disposal Practices at the Savannah River Plant" in *Disposal of Radioactive Wastes into the Ground, Proceedings of the Disposal of Radioactive Wastes into the Ground* (Vienna, Austria: International Atomic Energy Agency Conference, 1967), 101; National Research Council, *Radioactive Waste Management at the Savannah River Plant: A Technical Review* (Washington, DC: National Academy Press, 1981), 16.
84. Bebbington, *History of Du Pont at the Savannah River Plant*, (Wilmington, DE: E. I. Du Pont de Nemours and Company, 1990), 190.
85. Bebbington, *History of Du Pont at the Savannah River Plant*, (Wilmington, DE: E. I. Du Pont de Nemours and Company, 1990), 193-194.
86. David E. Lilienthal, *The Journals of David Lilienthal, Volume II, The Atomic Energy Years, 1945-1950* (New York: Harper and Row, 1964), 7.
87. Atomic Energy Commission, *A.E.C. Telephone Directory*, (Washington, DC: U.S. Atomic Energy Commission, 1947). On file, History Division, U.S. Department of Energy, Germantown, MD, Job 0017, Box 3301, Folder 3.
88. *New York Times*, "We Must Grasp the Facts about the Atom: Mr. Lilienthal Says Development of Atomic Energy Depends on our Knowledge of the Issues at Stake," May 4, 1947. On file, Biographical Files, History Division, U.S. Department of Energy, Germantown, MD; *New York Times*, "Atomic Energy is your Business: Lilienthal of the Atomic Energy Commission Urges Everyone to Become Familiar with this Miraculous Power" Magazine Section, January 11, 1948. On file, Biographical Files, History Division, U.S. Department of Energy, Germantown, MD; David Lilienthal, "Your Future in the Atomic Age," Transcript of Radio Broadcast, Prudential Family Hour, Columbia Broadcasting System, January 18, 1948. On file, Biographical Files, History Division, U.S. Department of Energy, Germantown, MD.

89. *Florida Times-Union*, "Lilienthal Expects Three Big Benefits from Atom Energy, January 19, 1948. On file, Biographical Files, History Division, U.S. Department of Energy, Germantown, MD.
90. Arthur Kemp, "The Role of Government in Developing Peaceful Uses of Atomic Energy," No. 461 in Series: *National Economic Problems* (Washington, DC: American Enterprise Association, Inc., 1956). On file at Hagley Museum and Library.
91. Office of Environmental Management, U.S. Department of Energy, *Nuclear Age Timeline: Poster Supplement and Resource Guide*, 1994, 16-17.
92. Atomic Energy Commission, *Seventeenth Semiannual Report of the Atomic Energy Commission, January 1955* (Washington, DC: Government Printing Office, 1955), vii.
93. Jon Jefferson, *Swords to Plowshares: A Short History of Oak Ridge National Laboratory*(Oak Ridge, TN: US Department of Energy, Oak Ridge National Laboratory, 1993), 8.
94. Office of Environmental Management, U.S. Department of Energy, *Nuclear Age Timeline: Poster Supplement and Resource Guide*, 1994, 15-17.
95. J. L. Crandall, *Status of the United States Effort in D₂O Reactor Physics* (Aiken, SC: Savannah River Laboratory, AEC Research and Development Report, September 1962), 8-9.; W. H. Arnold and W. D. Leggett, W. J. McShane, N. J. Liparulo, J. D. McAdoo, L. E. Strawbridge, G. Toto, H. K. Fauske and D. W. Call, *Westinghouse Independent Safety Review of Savannah River Production Reactors*, (Aiken, SC: Westinghouse Savannah River Company, 1989), xvii.
96. J. L. Crandall, *Status of the United States Effort in D₂O Reactor Physics*, 8.
97. W. H. Arnold and W. D. Leggett, W. J. McShane, N. J. Liparulo, J. D. McAdoo, L. E. Strawbridge, G. Toto, H. K. Fauske and D. W. Call, *Westinghouse Independent Safety Review of Savannah River Production Reactors*, xvii.
98. J. L. Crandall, *Status of the United States Effort in D₂O Reactor Physics*,7.; Carlisle and Zenzen, *Supplying the Nuclear Arsenal*, 90-91.
99. W. H. Arnold and W. D. Leggett, W. J. McShane, N. J. Liparulo, J. D. McAdoo, L. E. Strawbridge, G. Toto, H. K. Fauske and D. W. Call, *Westinghouse Independent Safety Review of Savannah River Production Reactors*, xvii.
100. David Lilienthal, "Change, Hope, and the Bomb," *Stafford Little Lectures, Lecture II Princeton University Lecture Delivered February 13, 1963*, 11.
101. C. P. Ross, "Cobalt-60 for Power Sources" in *Isotopes and Radiation Technology* 5(3) (Oak Ridge, TN: Isotopes Information Center, Oak Ridge National Laboratory, 1968), 185-194.; D. Thomas Rankin, P. Kent Smith, Phillip E. McBeath, James R. Keski and William R. McDonell, "Production of Co-60 Ceramic Fuel Forms" in *Ceramic Bulletin* 54 (11), published by the American Ceramic Society, 982-985.
102. W. P Overbeck and C. H. Ice and G. Dessauer, *Production of Transplutonium Elements at Savannah River*, Presentation, American Nuclear Society Meeting, Washington, DC, November, 1965, (SRS Document - DP-1000), 6,10.
103. J. L. Crandall, *Californium-252 Neutron Sources*, Presentation, American Nuclear Society's Topical Meeting on Applications of Californium-252,Austin, TX, September 1972, (SRS Document - DP-MS-72-45), 15.
104. William R. McDonell, A. R. Boulogne, J. P. Faraci, S. F. Peterson, B. L. Dahlen, W. C. Mosley, D. J. Mahoney and V. Whatley, *Preparation of Industrial Cf-252 Neutron Sources at Savannah River Laboratory*, Presentation, Neutron Sources and Applications, American Nuclear Society's Topical Meeting, Augusta, GA, April 1971 (Conference 710-402, Volume II), 72-85; V. W. Walker, *Equipment and Operations for Preparing Cf-252 Neutron Sources for Interstitial Cancer Radiotherapy Research*, Presentation, American Nuclear Society.
105. Bebbington, *History of Du Pont at the Savannah River Plant*, 225-226.
106. Carlisle and Zenzen, *Supplying the Nuclear Arsenal*, 181-182.
107. *Savannah River Plant News* (December 2, 1982).
108. *SRP News*, Various articles. On file, Savannah River Site Archives, January 21, 1982.
109. Bebbington, *History of Du Pont at the Savannah River Plant*, 228.
110. *Ibid.*, 138-143.
111. *Ibid.*, 228.
112. James Boswell, "Historical Perspective of U-Al Fueled Reactors at Savannah River", unpublished manuscript, 1990, 58.
113. League of Women Voters Education Fund, *The Nuclear Waste Primer*, (New York: Lyons & Burford , 1993), 39.

114. David Muhlbaier, Sam Mirshak, Vascoe Whatley, and Elwyn Wingo, "Experimental Thermal-Fluids Program in Support of Reactor Operations," in *Savannah River Site 50th Anniversary, Proceedings of the Symposium, May 17, 2000*, WSRC-MS-2000-00061 (Washington, DC Government Printing Office, 2000), 87.
115. Emergency Cooling System, 11/15/1983 (videotape on file, 83-049, video Services Master Library, Westinghouse Savannah River Company).
116. League of Women Voters Education Fund, *The Nuclear Waste Primer*, (New York: Lyons & Burford, 1993), 64-65.
117. Ibid.
118. Hearings Before the Subcommittee on Oversight and Investigations of the Committee on Energy and Commerce, House of Representatives, October 22, 1987 and May 11, (Washington, DC: U.S. Government Printing Office, 1988), 2.
119. Westinghouse Savannah River Company 1997a:1.2; 1997b:1.2; U.S. Department of Energy, Basis for Interim Operation (BIO) for the K-Reactor Facility. Westinghouse Savannah River Company, (Aiken, South Carolina, Engineering and Construction Division 1994a).
120. Lewis, Karen, Katherine Roxlau, Lori Rhodes, Paul Boyer and Joseph Murphey, *A Systematic Study of Air Combat Command Cold War Material Culture. Volume II-20; A Baseline Inventory of Cold War Material Culture at Moody Air Force Base*, (Albuquerque, NM: Mariah Associates, Inc., 1996), 50.

CHAPTER 3

1. Several web-based sites have good definitions of heavy water and its chemical compositions and uses. See en.wikipedia.org/wiki/Deuterium, www.everyscience.com/Chemistry/Glossary, web.em.doe.gov/takstock/glossary, wordnet.princeton.edu/perl/webwn.
2. Per F. Dahl, *Heavy Water and the Wartime Race for Nuclear Energy*. (Philadelphia: Institute of Physics Publishing, 1999), 28-30.
3. Ibid, 41-46.
4. W. P. Bebbington, V. R. Thayer and J. F. Proctor, eds., *Production of Heavy Water Savannah River and Dana Plants: Technical Manual, E. I. Du Pont de Nemours & Co., Explosives Division – Atomic Energy Division, DP-400*, (1959), 13-14.
5. Ibid, 178.
6. Ibid, 178-185.
7. "Heavy Water in the United States" in *Proc. Third International Conference on the Peaceful Uses of Atomic Energy, Vol. 12 Nuclear Fuels-III Raw Materials* (New York: United Nations, 1965), 334.
8. Ibid, 334-339.
9. Hugh K. Clark, "A Study of the Evidence Available to E. I. Du Pont de Nemours and Company Concerning the Validity of U.S. Patent No. 2,895,803 issued July 21, 1959 to Jerome Spevack." August 30, 1968, Hagley Museum and Library, Wilmington, Delaware, *Records of the Atomic Energy Commission*, Accession 1957, Series II, Box 6, Folder 19.
10. Manson Benedict, Thomas H. Pigford, and Hans Wolfgang Levi, *Nuclear Chemical Engineering, 2nd Ed.* (New York: Mc Graw-Hill Book Company, 1981), 770.
11. Bebbington et al., *Production of Heavy Water*, DP-400, 14.
12. J. W. (Bill) Morris, William P. Bebbington, Robert G. Garvin, Mal C. Schroder, and W. C. Scotten "Heavy Water for the Savannah River Site," in *50 Years of Excellence in Science and Engineering at the Savannah River Site, Proceedings of the Symposium, May 17, 2000*, WSRC-MS-00061 (Washington, DC: GPO, 2000) 11-18.
13. Engineering Department, E. I. Du Pont de Nemours and Co., *Savannah River Plant Engineering and Design History, Volume V, 400 Area, DPE-974* (1957), 19-20.
14. Girdler Corporation, *Dana Plant Construction History: Subcontractor for Engineering Department* (Wilmington, Delaware: E. I. Du Pont de Nemours & Co., 1952), Project 8987, DPEG-17, 1.
15. Clark, "Study of Evidence Available," *Hagley, Records of the Atomic Energy Division, Acc. 1957*, Series II, Box 6, Folder 19.
16. Richard G. Hewlett and Francis Duncan, *Atomic Shield: A History of the United States Atomic Energy Commission, Volume II, 1947-1952* (1962; reprint, Berkeley: University of California Press, 1990), 428-429.
17. Girdler Corporation. *Dana Plant Construction History, DPEG-17*, (1957), 1-4.
18. "Decisions and Commitments on Process, Service, Mechanical and Safety Problems"—*Dana Works Meetings November 7, 9, 10, 1950*, written by M.S. Bloomsburg, AEC Process Section to S. I. Winde, Project Design Manager Engineering Department, Hagley, Records of the Atomic Energy Division, Acc. 1957, Series IV, Box 44, Folder 1.

19. Morris et al., "Heavy Water for the Savannah River Site," 12.

CHAPTER 4

1. J. W. (Bill) Morris, William P. Bebbington, Robert G. Garvin, Mal C. Schroder, and W. C. Scotten "Heavy Water for the Savannah River Site," in *50 Years of Excellence in Science and Engineering at the Savannah River Site, Proceedings of the Symposium, May 17, 2000*, WSRC-MS-00061 (Washington, DC: GPO, 2000) 14.
2. Ranney wells are horizontal water collectors that have a central concrete caisson excavated to a certain depth at which well screens project horizontally in a radial manner. This well type is designed to capture water from a nearby surface water source and filter it. "In a practice referred to as riverbank filtration, the wells are designed to induce filtration from a nearby surface water source, combining the desirable features of groundwater and surface water supplies. The result is an abundant, dependable supply of high quality water with a constant temperature, low turbidity, and low levels of undesirable constituents such as viruses and bacteria." Quoted from D. Scot Riegart, "Reassessing Runney Wells – The Ins and Outs of Horizontal Collectors" in *Public Works Magazine*, April 15, 2006.
3. The Girdler Corporation, *Dana Plant Construction History* (Wilmington, DE Engineering Department E.I. du Pont de Nemours & Co., DPEG-17 1952), 79.
4. *Ibid.*, 2-4.
5. *Ibid.*, 8.
6. *Ibid.*, 147-180.
7. Morris et al., "Heavy Water for the Savannah River Site," 14.
8. *Ibid.*, 12; J. F. Proctor and V. R. Thayer, "Economics of Heavy Water Production" in *Chemical Engineering Progress* 58(4), 53-61, April 1962; William P. Bebbington, *History of Du Pont at the Savannah River Plant* (Wilmington, Delaware: E. I. du Pont De Nemours and Company, 1990), 41.
9. Bebbington, *History of Du Pont at the Savannah River Plant*, 41.
10. Morris et al., "Heavy Water for the Savannah River Site," 12.
11. D. F. Babcock, C. B. Buford, Jr., and J. W. Morris, S-Process Pilot Plant—First Run Results and Process Principles, DP-3 (Wilmington, Delaware, E. I. Du Pont de Nemours & Co. Explosives Department Atomic Energy Division, 1951).
12. Morris et al., "Heavy Water for the Savannah River Site," 13.
13. *Ibid.*, 13.
14. *Ibid.*, 13.
15. Morris et al., "Heavy Water for the Savannah River Site," 13; Benedict et al., *Nuclear Chemical Engineering*, 779, 178.
16. Engineering Department, E.I. du Pont de Nemours, Savannah River Plant Engineering and Design History Volume V, DPE-974, (Wilmington, DE 1957), 21-22.

CHAPTER 5

1. A.J. McCullin, Work Diary, 11/30/50 – 2/53, Atomic Energy Records, Du Pont Hagley Museum and Library, Series III, Box 17, Folders 5-6.p.6.
2. Engineering Department, E. I. du Pont de Nemours & Co. Savannah River Plant Engineering and Design History Volume V of VI (Wilmington, DE: 1957) DPE-974, 14.
3. Engineering Department, Savannah River Plant Engineering and Design History, 14.
4. Engineering Department, E. I. Du Pont de Nemours and Co., *Savannah River Plant Construction History, Volume IV, 400 Area*, DPE-1403 (1957), 156
5. The Lummus Company, *Savannah River Plant Engineering and Design History Volume I*, 1957, DPEL – 52, 18.
6. Engineering Department, Construction History, 180-182.
7. Engineering Department, Construction History, 190-191.

8. William P. Bebbington, *History of Du Pont at the Savannah River Plant*. (Wilmington, DE: E.I. Du Pont de Nemours and Company 1990), 23.
9. Bebbington, *History of Du Pont at the Savannah River Site*, 23.
10. Engineering Department, *Engineering and Design History*, 59
11. Engineering Department, *Engineering and Design History*, 101.
12. Engineering Department, *Engineering and Design History*, 85.
13. Engineering Department, *Engineering and Design History*, 186.
14. Bebbington, *History of Du Pont at the Savannah River Plant*, 46.
15. Proctor and Thayer, "Economics of Heavy Water Production," 53–61.

CHAPTER 6

1. Girdler Corporation, *Dana Plant Construction History*, DPEG-17, 81.
2. Bebbington, *History of Du Pont at the Savannah River Plant*, 43.
3. J. W. (Bill) Morris, William P. Bebbington, Robert G. Garvin, Mal C. Schroder, and W. C. Scotten "Heavy Water for the Savannah River Site," in *50 Years of Excellence in Science and Engineering at the Savannah River Site, Proceedings of the Symposium, May 17, 2000*, WSRC-MS-00061 (Washington, DC: GPO, 2000) 14.
4. Girdler Corporation. *Dana Plant Construction History*, DPEG-17, II–IV.
5. Girdler Corporation. *Dana Plant Construction History*, DPEG-17, 4, 11.
6. William P. Bebbington and Victor R. Thayer "....Production of Heavy Water" in *Chemical Engineering Progress* 55 (9) 70–78, September 1959.
7. Heavy Water Production and Production Costs Fiscal Year 1951 Through August of Fiscal Year 1956, DPW-4742-1, March 11, 1952, Hagley, Records of the Atomic Energy Division, Control Division, Explosives Department, Acc. 1957, Series IV, Box 45, Folder 14.
8. Morris et al., "Heavy Water for the Savannah River Site," 15.
9. Savannah River Plant History, GS Area, July 1954 through December 1972, DPSP-55-454-4, Calendar Year 1957, 47.
10. Morris et al., "Heavy Water for the Savannah River Site," 16.
11. Savannah River Plant History GS Area July 1954 through December 1972, DPSP-55-454-4, 64.
12. *Ibid.*, 78–79.
13. *Ibid.*, 141.
14. SRP News and Views, "AEC Chairman Lewis L. Strauss Pays Visit Here," April 15, 1955.
15. *Savannah River Plant News*, "Heavy Water for World Needs Supplied by SRP," November 8, 1957.
16. *Savannah River Plant News* 18 (12), July 10, 1970.
17. *Savannah River Plant History GS Area July 1954 through December 1972*, DPSP-55-454-4, 180.
18. Bebbington, *History of Du Pont at the Savannah River Plant*, 219–220.

GLOSSARY

Alpha particle

A positively-charged particle from the nucleus of an atom, emitted during radioactive decay.

Atom

A particle of matter which cannot be broken up by chemical means. Atoms have a nucleus consisting of positively-charged protons and uncharged neutrons of the same mass. The positive charges on the protons are balanced by a number of negatively-charged electrons in motion around the nucleus.

Atomic Bomb

An explosive device whose energy comes from the fission of heavy elements such as uranium or plutonium.

Becquerel (Bq)

A unit of radiation equal to one disintegration per second.

Beta Particle

A particle emitted from an atom during radioactive decay.

Biological Shield

A mass of absorbing material (e.g., thick concrete walls) placed around a reactor or radioactive material to reduce the radiation (especially neutrons and gamma rays respectively) to a level safe for humans.

Breed

To form fissile nuclei, usually as a result of neutron capture, possibly followed by radioactive decay.

Chain Reaction

A reaction that stimulates its own repetition, in particular where the neutrons originating from nuclear fission cause an ongoing series of fission reactions.

Containment Building

A containment building houses the reactor, pressurizer, reactor coolant pumps, steam generator and other equipment or piping containing reactor coolant. The containment building is an airtight structure made of steel-reinforced concrete. The base slab is approximately 9 feet thick; the vertical walls are 3 3/4 feet thick; and the dome is 3 feet thick.

Control Rods

Devices to absorb neutrons so that the chain reaction in a reactor core may be slowed or stopped.

Coolant

This is a fluid, usually water, circulated through the core of a nuclear power reactor to remove and transfer heat energy.

Core

The central part of a nuclear reactor containing the fuel elements and any moderator.

Critical Mass

The smallest mass of fissile material that will support a self-sustaining chain reaction under specified conditions.

Curie (Ci)

A unit of radiation measurement, equal to 3.7×10^{10} disintegrations per second.

Decay

Decrease in activity of a radioactive substance due to the disintegration of an atomic nucleus resulting in the release of alpha or beta particles or gamma radiation.

Decommissioning

Removal of a facility (e.g., reactor) from service, also the subsequent actions of safe storage, dismantling and making the site available for unrestricted use.

Depleted Uranium

Uranium having less than the natural 0.7% U-235. As a by-product of enrichment in the fuel cycle it generally has 0.25-0.30% U-235, the rest being U-238. Can be blended with highly-enriched uranium (e.g., from weapons) to make reactor fuel.

Deuterium

"Heavy Hydrogen", an isotope having one proton and one neutron in the nucleus. It occurs in nature as 1 atom to 6,500 atoms of normal hydrogen, (Hydrogen atoms contain one proton and no neutrons).

Dose Equivalent

The absolute measurement of exposure to a dose of ionising radiation depends upon the type of particle and the body tissue with which it interacts - hence the conversion to dose equivalent, which has units of rem. Rads are converted to rems by multiplying by a factor that depends upon the type of ionising radiation and its biological effect. For example, with gamma radiation the factor is 1 and a rad is equal to a rem.

Element

A chemical substance that cannot be divided into simple substances by chemical means; atomic species with same number of protons.

Enriched Uranium

Uranium in which the proportion of U-235 (to U-238) has been increased above the natural 0.7%. Reactor-grade uranium is usually enriched to about 3.5% U-235, weapons-grade uranium is more than 90% U-235.

Enrichment

Physical process of increasing the proportion of U-235 to U-238.

Fast Breeder Reactor (FBR)

A fast neutron reactor (q_v) configured to produce more fissile material than it consumes, using fertile material such as depleted uranium.

Fast Neutron Reactor (FNR)

A reactor with little or no moderator and hence utilising fast neutrons and able to utilise fertile material such as depleted uranium.

Fertile (of an isotope)

Capable of becoming fissile, by capturing one or more neutrons, possibly followed by radioactive decay. U-238 is an example.

Fissile (of an isotope)

Capable of capturing a neutron and undergoing nuclear fission, e.g., U-235, Pu-239.

Fission

The splitting of a heavy nucleus into two, accompanied by the release of a relatively large amount of heat and generally one or more neutrons. It may be spontaneous but usually is due to a nucleus absorbing a neutron.

Fission Products

Daughter nuclei resulting either from the fission of heavy elements such as uranium, or the radioactive decay of those primary daughters. Usually highly radioactive.

Fuel Assemblies

These are a group of fuel rods.

Fuel Fabrication

Making reactor fuel elements.

Gamma Rays

High energy electro-magnetic radiation.

Graphite

A form of carbon used in a very pure form as a reactor moderator.

Half-Life

The period required for half of the atoms of a particular radioactive isotope to decay and become an isotope of another element.

Heavy Water

Water containing an elevated concentration of molecules with deuterium ("heavy hydrogen") atoms.

Heavy Water Reactor (HWR)

A reactor which uses heavy water as its moderator.

High-Level Wastes

Extremely radioactive fission products and transuranic elements (usually other than plutonium) separated as a result of reprocessing spent nuclear fuel.

Highly (or High)-Enriched Uranium (HEU)

Uranium enriched to at least 20% U-235. Uranium in weapons is about 90% U-235.

Isotope

An atomic form of an element having a particular number of neutrons. Different isotopes of an element have the same number of protons but different numbers of neutrons and hence different atomic masses, e.g., U-235, U-238.

Joule

A unit of energy.

KeV

One thousand electron-volts. An electronvolt (symbol: eV) is the amount of energy gained by a single unbound electron when it falls through an electrostatic potential difference of one volt. This is a very small amount of energy.

Kilowatt

A Kilowatt is a unit of electric energy equal to 1,000 watts.

Kilowatt-Hour

This is a unit of energy consumption that equals 1,000 watts used for one hour. For example, ten 100-watt light bulbs burned for one hour use one kilowatt-hour of electricity.

Lattice

Structural configuration in a reactor organizing positioning of fuel rods, control rods, and safety rods.

Light Water

Ordinary water (H₂O) as distinct from heavy water.

Light Water Reactor (LWR)

A common nuclear reactor cooled and usually moderated by ordinary water.

Low-Enriched Uranium (LEU)

Uranium enriched to less than 20% U-235. Uranium in power reactors is about 3.5% U-235.

Megawatt (MW)

A unit of power, = 10⁶ Watts. MWe refers to electric output from a generator, MWt to thermal output from a reactor or heat source (e.g., the gross heat output of a reactor itself, typically three times the MWe figure).

Metal Fuels

Natural uranium metal as used in a gas-cooled reactor.

Micro

One millionth of a unit (e.g., microsievert is one millionth of a Sv).

Millirem

This is a measurement of the biological effects of different types of radiation equaling 1/1000th of a REM.

Mixed Oxide Fuel (MOX)

Reactor fuel which consists of both uranium and plutonium oxides, usually with about 5% Pu.

Moderator

A material such as light or heavy water or graphite used in a reactor to slow down fast neutrons so as to expedite further fission.

Natural Uranium

Uranium with an isotopic composition as found in nature, containing 99.3% U-238, 0.7% U-235 and a trace of U-234.

Neutron

An uncharged elementary particle found in the nucleus of every atom except hydrogen. Solitary mobile neutrons travelling at various speeds originate from fission reactions. Slow neutrons can in turn readily cause fission in

atoms of some isotopes, e.g., U-235, and fast neutrons can readily cause fission in atoms of others, e.g., Pu-239. Sometimes atomic nuclei simply capture neutrons.

Nuclear Reactor

A device in which a nuclear fission chain reaction occurs under controlled conditions so that the heat yield can be harnessed or the neutron beams utilised. All commercial reactors are thermal reactors, using a moderator to slow down the neutrons.

Oxide Fuels

Enriched or natural uranium in the form of the oxide UO₂, used in many types of reactor.

Plutonium

A transuranic element, formed in a nuclear reactor by neutron capture. It has several isotopes, some of which are fissile and some of which undergo spontaneous fission, releasing neutrons. Weapons-grade plutonium is produced with >90% Pu-239, reactor-grade plutonium contains about 30% non-fissile isotopes.

Pressurised Water Reactor (PWR)

The most common type of light water reactor (LWR).

Radiation

The emission and propagation of energy by means of electromagnetic waves or sub-atomic particles.

Radioactivity

The spontaneous decay of an unstable atomic nucleus, giving rise to the emission of radiation.

Radionuclide

A radioactive isotope of an element.

Radiotoxicity

The adverse health effect of a radionuclide due to its radioactivity.

rads

A unit to measure the absorption of radiation by the body. A rad is equivalent to 100 ergs of energy from ionising radiation absorbed per gram of soft tissue.

Reactor Vessel

It is the steel pressure vessel that holds the fuel elements in a reactor.

rem (Roentgen Equivalent Man)

REM is the common unit for measuring human radiation doses, usually in millirems (1,000 millirems = 1 rem).

Reprocessing

Chemical treatment of spent reactor fuel to separate uranium and plutonium from the small quantity of fission products (and from each other), leaving a much reduced quantity of high-level waste.

Shielding

Material, such as lead or concrete, that is used around a nuclear reactor to prevent the escape of radiation and to protect workers and equipment.

Spent Fuel

This is used nuclear fuel awaiting disposal.

Stable

Incapable of spontaneous radioactive decay.

Thermal Reactor

A reactor in which the fission chain reaction is sustained primarily by slow neutrons (as distinct from Fast Neutron Reactor).

Transuranic Element

A very heavy element formed artificially by neutron capture and subsequent beta decay(s). Has a higher atomic number than uranium (92). All are radioactive. Neptunium, plutonium and americium are the best-known.

Uranium

A mildly radioactive element with two isotopes which are fissile (U-235 and U-233) and two which are fertile (U-238 and U-234). Uranium is the basic raw material of nuclear energy.

Uranium Oxide Concentrate (U308)

The mixture of uranium oxides produced after milling uranium ore from a mine. Sometimes loosely called yellowcake. It is khaki in colour and is usually represented by the empirical formula U₃O₈. Uranium is exported from Australia in this form.

Vitrification

The incorporation of high-level wastes into borosilicate glass, to make up about 14% of the product by mass.

Waste

High-level waste (HLW) is highly radioactive material arising from nuclear fission. It is recovered from reprocessing spent fuel, though some countries regard spent fuel itself as HLW and plan to dispose of it in that form. It requires very careful handling, storage and disposal.

Waste

Low-level waste is mildly radioactive material usually disposed of by incineration and burial.

Yellowcake

Ammonium diuranate, the penultimate uranium compound in U308 production, but the form in which mine product was sold until about 1970.

Sources Used:

www.gnep.energy.gov/gnepGlossaryOfTerms.html;

<http://www.sea-us.org.au/glossary.html>

SUGGESTED READING

Albright, David, Frans Berkhout, and William Walker

1993 *World Inventory of Plutonium and Highly Enriched Uranium, 1992*. Oxford University Press, New York.

Bebbington, W.P.

1990 *History of DuPont at the Savannah River Plant*. Published by E. I. Du Pont de Nemours and Company, Wilmington, DE.

Bilderback, D.R.

1995 Documenting South Carolina's Military Bases and Cold War Legacy. In *Preserving the Recent Past*, edited by Deborah Slaton and Rebecca Shiffer, Heritage Preservation Education Foundation, Washington, DC.

Browder, Tonya Algerine, Richard David Brooks, and David C. Crass

1993 *Memories of Home: Dunbarton and Meyers Mill Remembered*. Archaeological Research Heritage Series 1. Occasional Papers of the Savannah River Archaeological Research Program, Community History Project. South Carolina Institute of Archaeology and Anthropology University of South Carolina.

Browder, Tonya Algerine and Richard David Brooks

1996 *Memories of Home: Reminiscences of Ellenton*. Savannah River Archaeological Research Heritage Series 2. Occasional Papers of the Savannah River Archaeological Research Program, Community History Project. South Carolina Institute of Archaeology and Anthropology University of South Carolina.

Buley, Rex D., and Don J. Green

1995 "Tritium Processing and Containment at the Savannah River Site," in *Fusion Technology*, 28 (October): 1307-1311, American Nuclear Society, Inc., La Grange Park, Illinois. On file, Georgia Institute of Technology.

Cabak, Melanie A. and Mary M. Inkrot

1997 *Old Farm, New Farm An Archaeology of Rural Modernization in the Aiken Plateau, 1875-1950*. Savannah River Archaeological Research Papers No. 9. Occasional Papers of the Savannah River Archaeological Research Program, South Carolina Institute of Archaeology and Anthropology, University of South Carolina.

Carlisle, Rodney P., and Joan M. Zenzen

1996 *Supplying the Nuclear Arsenal American Production Reactors, 1942-1992*. The John Hopkins University Press, Baltimore and London.

Center for Air Force History

1994 *Coming in from the Cold: Military Heritage in the Cold War*. Report on the Department of Defense Legacy Cold War Project, Washington, DC.

Chapin, F. Stuart and Theodore W. Wirths, Alfred M. Denton and John C. Gould

1954 *In the Shadow of a Defense Plant: A Study of Urbanization in Rural South Carolina*. Institute for Research in Social Science, University of North Carolina, Chapel Hill, NC.

Cochran, T. B.

1984 *Nuclear Weapons Databook*. Ballinger Publishing Company, Cambridge, Massachusetts.

Crandall, J. L.

1962 Status of the United States Effort in D₂O Reactor Physics. AEC Research and Development Report, Savannah River Laboratory, Aiken, South Carolina, September 1962. DP-787.

1972 Californium-252 Neutron Sources. Paper for presentation, American Nuclear Society National Topical Meeting on Applications of Californium-252, Austin, Texas, September 11, 1972. DP-MS-72-45.

Dahl, Per F.

1999 *Heavy Water and the Wartime Race for Nuclear Energy*. Institute of Physics Publishing, Bristol and Philadelphia.

E.I. Du Pont de Nemours & Company

1952 *DuPont The Autobiography of An American Enterprise*. Charles Scribner, New York.

1954 *This is Du Pont, The Story of Safety*. Wilmington, Delaware. On file, Hagley Museum and Library, Wilmington, Delaware.

1977 *Occupational Safety and Health: A Du Pont Company View*. Wilmington, Delaware. Document Number SRS-98-0139.

Engineering Department, E.I. Du Pont de Nemours & Co.

1957a Savannah River Plant Construction History, Volumes I-IV. Prime Contractor for United States Atomic Energy Commission. U.S. Contract No. AT(07-2)-1, Du Pont Project 8980. DPE-1403, on deposit at the Hagley Museum and Library, Wilmington, Delaware.

- 1957b Savannah River Plant Engineering and Design History, Volume I, Administration. Prime Contractor for United States Atomic Energy Commission. U.S. Contract No. AT(07-2)-1, Du Pont Project 8980. DPE-972, on deposit at the Hagley Museum and Library, Wilmington, Delaware.
- 1957c Savannah River Plant Engineering and Design History, Volume II, #100 Areas. Prime Contractor for United States Atomic Energy Commission. U.S. Contract No. AT(07-2)-1, Du Pont Project 8980. DPE-972, on deposit at the Hagley Museum and Library, Wilmington, Delaware.
- 1957d Savannah River Plant Engineering and Design History, Volume III, #200-F and H Areas. Prime Contractor for United States Atomic Energy Commission. U.S. Contract No. AT(07-2)-1, Du Pont Project 8980. DPE-972, on deposit at the Hagley Museum and Library, Wilmington, Delaware.
- 1957e Savannah River Plant Engineering and Design History, Volume IV, #300/700 Areas. Prime Contractor for United States Atomic Energy Commission. U.S. Contract No. AT(07-2)-1, Du Pont Project 8980. DPE-972, on deposit at the Hagley Museum and Library, Wilmington, Delaware.
- 1957f Savannah River Plant Engineering and Design History, Volume V, #400 Area. Prime Contractor for United States Atomic Energy Commission. U.S. Contract No. AT(07-2)-1, DuPont Project 8980. DPE-972, on deposit at the Hagley Museum and Library, Wilmington, Delaware.
- 1960 History of the "S" projects, 1953-1960. Prime Contractor for United States Atomic Energy Commission. On deposit at the Hagley Museum and Library, Wilmington, Delaware.
- Fehner, Terrence R., and Jack M. Holl
- 1994 Department of Energy, 1977-1994: A Summary History. History Division, Department of Energy.
- Fine, Lenore, and Jesse A. Remington
- 1989 "Atomic Mission" (Chapter XX) in United States Army in World War II: The Technical Services. The Corps of Engineers: Construction in the United States. Center of Military History, United States Army, Washington, D.C. (First Printed 1972).
- Gibbs & Hill. Inc.
- 1954 Savannah River Plant Engineering and Design History, Volume IV, Water Supply. Subcontractor for Engineering Department, E. I. Du Pont de Nemours & Co. Inv. Prime Contractor for United States Atomic Energy Commission. U.S. Contract No. AT(07-2)-1, Du Pont Project 8980 Subcontract No. AXC-5 1/2. DPEZ-380, on deposit at the Hagley Museum and Library, Wilmington, Delaware.
- Gibbs & Hill. Inc
- 1954 Savannah River Plant Engineering and Design History, Volumes I through V. Subcontractor for Engineering Department, E.I. Du Pont de Nemours & Co. Inv. Prime Contractor for United States

Atomic Energy Commission. U.S. Contract No. AT(07-2)-1, Du Pont Project 8980 Subcontract No. AXC-5 1/2. DPEZ-380, on deposit at the Hagley Museum and Library, Wilmington, Delaware.

Girdler Corporation

1952 *Dana Plant Construction History*. Subcontractor for Engineering Department, E. I. Du Pont de Nemours & Co. Inv. Prime Contractor for United States Atomic Energy Commission. U.S. Contract No. AT(07-2)-1, Du Pont Project 8987 Subcontract No. ADC 1 1/2. DPEG-17, on deposit at the Hagley Museum and Library, Wilmington, Delaware.

Gosling, F. G.

1994 *The Manhattan Project: Making the Atomic Bomb*. U.S. Department of Energy, History Division. September 1994. On file, American Museum of Science and Energy.

Groves, Leslie R.

1962 *Now It Can Be Told: The Story of the Manhattan Project*. Harper and Brothers, New York.

Hearings Before the Subcommittee on Oversight and Investigations of the Committee on Energy and Commerce, House of Representatives

1988 Hearings Before the Subcommittee on Oversight and Investigations of the Committee on Energy and Commerce, House of Representatives, One Hundredth Congress, October 22, 1987, and May 11, 1988, Serial No. 100-138, Safety at DOE Nuclear Weapons Facilities. U.S. Government Printing Office, Washington, D.C.

Heavy Water Components Test Reactor

c.1962 Brochure, Savannah River Laboratory, Aiken, South Carolina. On file, Savannah River Site History Project.

Hennelly, E. J.

1969 Production of Cf-252 at Savannah River: Past Accomplishments and Future Plans. Savannah River Laboratory, Aiken, South Carolina. Paper for presentation, 157th National Meeting, American Chemical Society, Minneapolis, Minnesota, April 13-18, 1969. DP-MS-68-108.

Hewlett, Richard G., and Oscar E. Anderson, Jr.

1990 *The New World: A History of the United States Atomic Energy Commission, Volume I, 1939-46*. University of California Press, Berkeley.

Hewlett, Richard G., and Francis Duncan

1990 *Atomic Shield A History of the United States Atomic Energy Commission, 1947-1952*. Volume II. University of California Press, Berkeley.

Holl, Jack M and Richard G. Hewlett and Ruth R. Harris

1997 *Argonne National Laboratory, 1946-96*. University of Illinois Press, Urbana and Chicago.

Hood, R. R.

1965 *Heavy Water Moderated Power Reactors, Progress Report, November-December 1964*. AEC Research and Development Report, Savannah River Laboratory, Aiken, South Carolina, January 1965. DP-945.

HWCTR: A High-Flux Reactor for Testing Fuel Elements and Components

1964 Brochure, E. I. Du Pont de Nemours and Company, Savannah River Plant, Aiken, South Carolina. On file, SRS-89-0139 (Pamphlet History, 1952-1982, vol. 1).

Jefferson, Jon

1993 *Swords to Plowshares: A Short History of Oak Ridge National Laboratory*. Edited by Sybil Wyatt and Cindy Robinson. Booklet published by Oak Ridge National Laboratory, Office of Public Affairs, U.S. Department of Energy. On file, American Museum of Science and Energy.

Johnson, Leland, and Daniel Schaffer

1992 *Oak Ridge National Laboratory Review*. Volume 25, Nos. 3 and 4. Martin Marietta Energy Systems, Department of Energy.

Jones, Vincent C.

1998 *United States Army in World War II. Special Studies Manhattan: the Army and the Atomic Bomb*. Center of Military History, United States Army, Washington, D.C.

Kemp, Arthur

1956 *The Role of Government in Developing Peaceful Uses of Atomic Energy*. No. 461 in Series National Economic Problems. Published and distributed by the American Enterprise Association, Inc., Washington, D.C. On file, Hagley Museum and Library.

Kiger, Eugene O.

1966 *Operational Summary of the Heavy Water Components Test Reactor, October 1961-December 1964*. Savannah River Laboratory, Aiken, South Carolina, April 1966. DP-991.

Lewis, Karen, Katherine Roxlau, Lori Rhodes, Paul Boyer and Joseph Murphey

1995 *A Systematic Study of Air Combat Command Cold War Material Culture*. Volume II-20; A Baseline Inventory of Cold War Material Culture at Moody Air Force Base. Mariah Associates, Inc. Albuquerque, NM.

Lilienthal, David E.

- 1964 *The Journals of David E. Lilienthal, Volume II, The Atomic Energy Years, 1945-1950*. Harper and Row, New York. On file, History Division, U.S. Department of Energy.

McDonell, William R., A. R. Boulogne, J. P. Faraci, S. F. Peterson, B. L. Dahlen, W. C. Mosley, D. J. Mahoney, and V. Whatley

- 1971 "Preparation of Industrial Cf-252 Neutron Sources at Savannah River Laboratory," *Neutron Sources and Applications*. American Nuclear Society Topical Meeting, April 19-21, 1971, Augusta, Georgia. Conf-710-402, Volume II, pp. 1.72-85. On file, Savannah River Site History Project.

Mitchell, Kris C.

- 2003 *Rhetoric to Reality: A Cold War Context Statement for the Pantex Plant, 1951-1991*. Prepared by BWXT Pantex, LLC., for U.S. Department of Energy, National Nuclear Security Administration, Pantex Site Office.

National Research Council

- 1981 *Radioactive Waste Management at the Savannah River Plant: A Technical Review*. National Academy Press, Washington, D. C.

New York Shipbuilding Corporation

- 1949 *Fifty Years New York Shipbuilding Corporation, Camden, NJ*. Published by New York Shipbuilding Corporation

Oak Ridge National Laboratory Review

- 1992 *ORNL The First Fifty Years*. US. Department of Energy/Martin Marietta Energy Systems. Volume 25, Nos. 3 and 4.

Okrent, David

- 1981 *Nuclear Reactor Safety, On the History of the Regulatory Process*. The University of Wisconsin Press, Madison, WI.

Overbeck, W. P.

- 1978 Production of Radioisotopes at the Savannah River Plant. Text of a presentation, dated December 31, 1978. SRL-78-003.

Overbeck, W. P., C. H. Ice, and G. Dessauer

- 1965 Production of Transplutonium Elements at Savannah River. Paper prepared for presentation, Winter Meeting of American Nuclear Society, November 15-18, 1965, Washington, D.C. Savannah River Laboratory, Aiken, South Carolina. DP-1000.

- Reed, Mary Beth, Mark T. Swanson, Steven Gaither, J. W. Joseph, and William R. Henry
2002 *Savannah River Site at Fifty*. U.S. Government Printing Office, Washington, D.C.
- Rhodes, Richard
1986 *The Making of the Atomic Bomb*. Simon & Schuster, New York.
- Ridgely, G. C.
1985 SRP Reactor Incidents of Greatest Significance. Memorandum to G. F. Merz, August 14, 1985. On file, RTR-2316 Savannah River Site Archives.
- Ross, C. P.
1968 "Cobalt-60 for Power Sources," *Isotopes and Radiation Technology* 5(3):185-194. *Isotopes Information Center, Oak Ridge National Laboratory*. On file, Savannah River Site History Project.
- Savannah River Plant (SRP)
ca. 1954 *Savannah River Plant History, All Areas, August 1950 through June 1953*. Document Number DPSP-53-368.
ca. 1955 *Savannah River Plant History, All Areas, July 1953 through June 1954 (Deleted Version)*. On file, Document Number DPSP-54-448, Savannah River Site Archives.
ca. 1973 *Savannah River Plant History, Separations Areas, July 1954 through December 1972 (Deleted Version)*. Document Number DPSP-55-454-2.
- Smyth, Henry D.
1945 *Atomic Energy for Military Purposes The Official Report on the Development of the Atomic Bomb under the Auspices of the United States Government*. Princeton University Press, Princeton, New Jersey.
- Thayer, Harry
1996 *Management of the Hanford Engineer Works in World War II, How the Corps, DuPont and the Metallurgical Laboratory Fast Tracked the Original Plutonium Works*. American Society of Civil Engineers, New York.
- The USC Legacy Project, Department of History, University of South Carolina
1995 *The Cold War in South Carolina, 1945-1991 An Inventory of Department of Defense Cold War Era Cultural and Historical Resources in the State of South Carolina*. Prepared for the Legacy Resource Management Program, United States Department of Defense, Demonstration Project No. DODC-6. Administered by the U.S. Army Environmental Center Legacy Program, Aberdeen Proving Ground, MD.

United States Department of Energy

- 1994 Nuclear Age Timeline: Poster Supplement and Resource Guide. Poster and Booklet prepared by U.S. Department of Energy, Office of Environmental Management, October 1994. On file, New South Associates.
- 1996 *Plutonium: The First 50 Years, United States Plutonium Production, Acquisition, and Utilization from 1944 through 1994*. February. Document Number DOE/DP-0137. U. S. Department of Energy, Washington, D. C.

United States Department of Energy, Office of Environmental Management

- 1997 *Linking Legacies: Connecting the Cold War Nuclear Weapons Production Processes To Their Environmental Consequences*. Office of Strategic Planning and Analysis, DOE, Washington, DC.

Voorhees, Walker, Foley and Smith

- 1957 Construction History, Savannah River Plant. Subcontractor for Engineering Department, E. I. Du Pont de Nemours & Co. Inv. Prime Contractor for United States Atomic Energy Commission, Project 8980. Volumes I and II. On deposit at the Hagley Museum and Library, Wilmington, Delaware.

Walker, V. W.

- 1975 *Equipment and Operations for Preparing Cf-252 Neutron Sources for Interstitial Cancer Radiotherapy Research*. Paper proposed for Remote Systems Technology Conference, American Nuclear Society, San Francisco, California, November 16-21, 1975. Prepared by V. W. Walker, Savannah River Laboratory, E. I. Du Pont de Nemours and Company, Aiken, South Carolina. DP-MS-75-9.

APPENDIX A

ORAL HISTORY TRANSCRIPTIONS

NEW SOUTH ASSOCIATES' INTERVIEW WITH
WILLIAM BEBBINGTON, APRIL 16, 2007

Interviewee: William Bebbington

Interviewer: Mark Swanson, New South Associates

Date of Interview: April 16, 2007

Mark Swanson: This is an interview with Mr. William Bebbington, conducted by Mark Swanson, historian with New South Associates, being conducted on April 16th, 2007. Bill, if you don't mind, give me your full name.

Wm. Bebbington: William Pearson Bebbington.

MS: What is your background - either personal or academic, whichever you want to go with, or both?

WB: Well, first off, I am, or was, a chemical engineer. I got a bachelor's degree in chemistry from Cornell in 1936 and a Ph.D. in chemical engineering in 1940.

MS: Where were those at?

WB: Cornell.

MS: When did you start working at Savannah River Site?

WB: I came here in 1952.

MS: What about- Bill Morris has referred to heavy water production at Dana and SRP as a "saga." Is that a good description of what happened?

WB: I think that is a fair description, yes. He and I were both involved with it.

MS: What was his role in design and development of Dana?

WB: I don't think Bill had much to do with- and I may be wrong, but I don't think so- much to do with the design and development. I did, and I did not even meet Bill, I guess, until Dana was pretty well along, and he was there. I met him there.

MS: What about your role in the design and development of Dana?

WB: Well, the Girdler Company- we have to go back a little bit, and I won't go much into this, but the basic design was done at Columbia University where Harold Urey was the discoverer of heavy hydrogen. One of the things that everybody wanted to do was figure out a way to separate - I think there's only 7 parts in 100 of deuterium in overall hydrogen mixture, and that's true in water too. So the goal was to find out a process to separate it. Well, there are fairly simple ones. Electrolysis probably gave the best separation, but it was hard to do that on a large scale. And distillation was one and could be done on a very large scale - but the separation factor wasn't very good. In other words, there's not much difference in the volatility between D₂O and H₂O. So, then, Urey's people discovered that by exchange of deuterium between water and hydrogen sulfide gas, working counter-currently in what's known as scrubber towers, you got a pretty good separation. But it had to be done under considerable pressure. I've forgotten, probably 300 or 400 pounds per square inch. That was brand new. Well, a graduate student under Harold Urey, Jerry Spevack, had developed, under Urey's direction, this process. He designed a pilot plant, and that pilot plant was the first thing to be built at Dana, which was an ordinance plant making explosives- one of several. So, then at the same time, DuPont had gotten into the act and decided- it had been decided, that the reactors at Savannah River would be heavy water-moderated. There were lots

of advantages over graphite for that, which was used at Hanford. Of course, you get a lot of that in the book [Bebbington's "History of Du Pont at the Savannah River Plant"]. So, I'd had experience— I started with DuPont at the Bell Works in West Virginia and had useful background from there and also from my college work, so it was logical. It was a chemical engineering problem. So, I got sent to that. Well, in the meantime, the AEC had contracted with Girdler Corporation to design and build a production heavy water plant at Dana. So, I got involved with the Girdler engineers, in fact, I even spent a week or two in Louisville working with them on the calculations for the plant.

- MS: Ok, let's see, how old were you and Bill Morris when you all were doing this work at Dana?
- WB: (laughs) I think I must have been about 35. And Bill was close to the same age.
- MS: We talked about some of this already, but which individuals were the most important in heavy water research, in academia and also at DuPont?
- WB: DuPont did none.
- MS: Didn't have any?
- WB: Yeah. And Urey and his co-workers were it. Abroad, there must have been some others. I know the Norwegians were in it very early, with an electrolytic plant. We may get around to this later, but both the French and the Germans built heavy water separation plants.
- MS: Yeah, we'll get into that in a little bit later in terms of which countries went with heavy water and which ones did not. You mentioned Jerome Spevack already. Once again, how did he figure into the heavy water production, and what was his relationship to Du Pont?
- WB: There was none, essentially. He came and went. I wouldn't give him the role or title of "consultant," but more "observer" would be better.
- MS: Who did he work for again?
- WB: H.C. Urey.
- MS: And who did they work for?
- WB: He was an academic. He was in the chemistry faculty at Columbia University.
- MS: As far as Jerome Spevack was concerned, what was his role in D Area construction and design? Or was he even involved at all?
- WB: Not at all.
- MS: Who was involved in design of D Area?
- WB: Completely Du Pont. We, and the Production and Manufacturing end. And Girdler, well, (??) on to Dupont. And the engineering department people ordinarily do the design of the equipment.
- MS: So, Girdler was the main – DuPont got most of their information from Girdler as far as –
- WB: They got some – I need to make that clear. Before Dana was even complete, it was decided because of the size of the Savannah River project and reactors, that we would have to have more than one heavy water plant. So then Du Pont went ahead and designed a plant at the Ordinance Works at Morgantown, West Virginia, and also the one at Wabash River Ordinance Works – that's the one at Dana – and the Alabama Ordinance Works at Childersburg, Alabama. So that was the big effort of Du Pont, designing those two plants. And they immediately, having designed one for Dana, they decided where they could make the other two somewhat better, and so on. But they all went up, essentially together.
- MS: When did they go up?

- WB: I can't tell you the exact dates, Mark, but we're talking now of having to have the heavy water available to Savannah River by 1952. So I would guess they must have started building the earliest of them in 1950. Or right around there.
- MS: That's what I would have guessed. After they made the decision they were going to go with the new reactors, almost immediately they determined they were going to be heavy water. So I guess they probably worked on that initially.
- WB: See, that was the advantage that the AEC had wanted from getting Du Pont. They did have this broad capability of bringing a whole mess of people in all at once and doing it.
- MS: Right, that's true.
- WB: And if you read the book, that's what Mr. Greenewalt says. Dr. Greenewalt, I should say.
- MS: When Dana was shut down, did the workers from there go to Savannah River Site?
- WB: Now, by workers, you mean the technical people – well, the only workers who went were technical and supervisory. A good share of them went.
- MS: So the regular workers would not have –
- WB: No, not the hourly people.
- MS: What percentage, would you say, came down from Dana? Or is that even knowable at this point?
- WB: I don't know. I never was there, except occasionally for a visit and never was involved with the administration of it.
- MS: Right. Now we talked about D Area construction design. Were you involved in that?
- WB: Yes. Again, I was involved with the chemical engineering calculations of the separations thing but not with the design of the plant itself. That was the engineering department people primarily.
- MS: What was your role in D Area's operation?
- WB: I was sent there in 1952 to be in charge of the Works Technical Department section that provided technical support for the production department. We helped write the operating manuals and technical manuals, and my staff worked right in the manufacturing buildings with the production staff. They observed, advised, and so forth. There was a standard operating practice for Du Pont, to set up such.
- MS: What were the major process concerns in D Area?
- WB: Ooh, we had a lot of them. The first place –
- MS: I imagine corrosion was a big one.
- WB: First place, let me say that with the so-called GS process, which was the H₂S exchange process– and GS, incidentally, is not "Gerry Spevack," it's Girdler-Sulfide. (laughs) And that only went to, I guess, somewhere between 5 and 10 percent of the D₂O in the mixture. And then after that, it went to water distillation, which was called DW, for "Du Pont water," to go up to above 90 percent. And then finally electrolytic, or E, to take it all the way to essentially 100 percent D₂O. Very close to it. Here's some (hands something to MS). See how heavy it is?
- MS: Hm, feels like regular water!
- WB: Yeah, it is.
- MS: I always thought, when I first heard of heavy water, that it was appreciatively heavy, that you could really tell the difference. Somebody told me, I don't know why this came up sometime, but somebody told me that that you could not live on heavy water. If that's all you had to drink.

- WB: That's a lot of baloney. I don't know if there would be any subtle biological effects or not. But as far as the human body or any other- you could grow plants with it or anything else. Chemically, there's no difference. See, if there were any chemical difference, it would not have been so damned hard to separate it.
- MS: Chemically, that's something Du Pont could do.
- WB: Well, we did.
- MS: Well, you did it anyways, but if it were purely chemical – that's the reason DuPont got involved, because of Separations.
- WB: Well, Du Pont got involved, of course, because they had run Hanford. And the government came begging for them to do it. See, when they through with Hanford, they said (rubs hands together) "No more of that." It wasn't in their line of business, you see. But then they came back again and begged them.
- MS: Right, that's true. Talking about the major concerns, though, and the process.
- WB: OK, there were several. It was a high-pressure process. H_2S water is corrosive. Control of the process had to be very careful. The ratio of water flow down, to H_2S flow up, had to be carefully controlled. There was no simple way to analyze it. You couldn't pour a reagent in and do it like in the laboratory. For the most part, you had to use mass spectrometers to measure concentrations. So all those were stiff problems.
- MS: How were they dealt with, especially the corrosion problem?
- WB: There, we relied a great deal on the engineering department and their staff of metallurgists, and so forth. We did a variety of things- used stainless steel whenever we could. Some of the towers were just plain carbon steel, but the plates were stainless steel. So that was the way they did that. There wasn't any inhibitor that you could put in to take care of it.
- MS: Safety, from all I've heard, safety was a big issue in D Area.
- WB: It was indeed, because H_2S is highly toxic. Fortunately, you can smell it. However, if you smell a little bit of it, your nose is quickly numbed to smelling an increased concentration of it. So we had quite elaborate system. First place, there was something like a roll of litmus paper, which would turn black if there was H_2S in the air. And you always used those. But no person ever went alone into that area. You always used a buddy system. You didn't go side by side, because then if you got into gas, you both get it. So the two buddies stay ten or fifteen feet apart so that if one was knocked down, the other could sound an alarm. The result was that we never had a serious injury or fatality from hydrogen sulfide gas.
- MS: Were there any particularly close calls with hydrogen sulfide gas?
- WB: I don't think so, Mark. As the book says, that was a very safe plant. Any injuries we had in that D Area was other things. We even had a couple of men killed, but they were killed by being scalded by hot water when they opened the pipe and it gushed out at them. One of them fell off a scaffold and was hurt, things like that. Not really process-related.
- MS: Who were the major players in the production of heavy water at Savannah River Site?
- WB: Well, Fred Endorf was my opposite number as the production manager for heavy water. Under him, he had, I can't remember their names off-hand – one man was in charge of GS, one in charge of part of the E plant was my daughter's father-in-law (laughs), Warren Long. And then, I've forgotten who was in charge of the distillation plant now.
- MS: You said "Warren Long" right?

- WB: Yeah.
- MS: As far as people who are working with heavy water at Savannah River, did think that was going to be the way of the future in nuclear industry?
- WB: I don't think we thought very much about it, frankly. Of course, it's still not a settled issue.
- MS: Yeah, it seems like certainly the nuclear power industry has pretty much gone with light water, in this country.
- WB: Well, the Canadians went the other way. They had the biggest heavy water plants that have ever been built, far bigger than D Area.
- MS: Why did they go the other way?
- WB: I think they probably came to the same conclusion that we did when we built the Savannah River Plant and decided to use heavy water-moderated reactors instead of the old graphite piles. This is out of my area, but there were both advantages from the nuclear end, and from the engineering end.
- MS: Why did we elect to use light water power reactors? Was it because of the Navy?
- WB: No, I don't think so (long pause). You're out of my depth.
- MS: OK, what about – maybe in earlier years, maybe the 50s and 60s, how did the power industry view heavy water and its uses?
- WB: In Canada, they thought it was great. In the United States, we completely rejected it. I don't think we have a heavy water-moderated power reactor in the United States.
- MS: I could be wrong on this, but was the Parr Reactor in South Carolina, was that heavy water? It may have been an experimental thing.
- WB: I think it was kind of experimental.
- MS: That probably was created because of the Savannah River Site being so close by, but that went on-line, I think in the early '60s.
- WB: I never kept up very much with the power industry.
- MS: But yeah, you're right, aside from that, I don't think there's been anything.
- WB: What was your background?
- MS: History and anthropology (laughs). They've had me on these things for a long time. I have no background in physics whatsoever. When we first got introduced to this particular project, every time I would ask Cy Banick, who was our historical advisor, some question, he would always go to the nuclear periodic table and show me certain things. Beta particles going here and something else going there, and I remember thinking, "I'll never get this."
- WB: Well, join the club. (Mark laughs)
- MS: But talking about different countries where heavy water was better appreciated for power reactors – among those were Canada?
- WB: Canada, above all. I am not real familiar with, for example, France. I think they are now generating something like 80% of their energy in nuclear reactors. I do not know whether they are heavy water-moderated. Canada, on the other hand, elected to go that way. And I guess most, if not all, of their plants are heavy water-moderated. But how many they have, I don't know. It's pretty well available. I think you can go on Google and get all that.
- MS: I think that somebody told me that the Japanese had some.

- WB: Japanese are very interested.
- MS: And maybe the Swedes had some interest in that as well.
- WB: Quite likely.
- MS: Here's the next question. Did Savannah River Plant have close affiliation with Canada and France because of shared technology?
- WB: Canada, yes. France, no. Now, I'll give you a little side-trip here. Back in the time when we were first going into the business, I was sent over to France and Germany to talk with the people there who had heavy water separation plants. And that was kind of interesting. They did- I think, I can't remember, neither of them was using the H₂S exchange process. I think they both may have been using water distillation followed by electrolysis. But of course, the French word for heavy water is "l'eau lourde" and that was kind of an apt thing. But the Germans, that was even better. I asked one of their engineers, and of course, they all speak English fluently. I think they sent me there because I spoke a little bit of French and German, but I didn't have to use any of it except ordering food in restaurants and things like that. But in Germany, they referred to the plant as - in France, it was done by "L'électricité du France"- in Germany it was done by a dye company, "Farbwerke Hoechst," and they referred to the heavy water plant as their "Millionen Grab" - "grave of millions"- of marks.
- MS: (laughs) Yeah, that's probably appropriate.
- WB: You know, there was another interesting sidelight on that. When I went there, you would go to those plants, and all the workers went to work on bicycles. In fact, they had a problem of safe parking of bicycles. So they had a neat trick of having a lot of pulleys up there, and you hooked your bike onto a hook on a rope and pulled it up. I guess you had your own key to the lock or something, but there it was. Later years, I went back, next time I went back, and all the workers had Volkswagens. Next time I went back, they all had BMWs.
- MS: Yeah, I was going to say, I see a progression there. I can believe that. When was the first time you went over to Germany?
- WB: That would have been around, I guess, 1950. I'm trying to figure that out right now. I'm trying to write a family history, and I never kept a diary. I kick myself, because I didn't.
- MS: When did Savannah River Plant start to sell heavy water as a product?
- WB: I haven't any idea. That was out of my - I don't know. Or how much they sold.
- MS: This you might know, even if you don't know the answer to that one - what were the uses of heavy water, if it was being sold as a product?
- WB: I can't think of any except as a moderator of reactors, except for minor scientific biological tests and that sort of thing.
- MS: Was it a big sales volume, or do you have any idea?
- WB: I suppose eventually they must have sold what they had in stock. I don't imagine they have any around.
- MS: Yeah I guess - they don't need it now. When this was being done, was DOE handling this? Or did Du Pont do it?
- WB: I presume that it would have been AEC most of the time. DOE later. Du Pont took no role in that. It was their job to make it and make it safely. It had no sales force. Because they weren't making a nickel out of it.

- MS: Well, they say that D Area was the first of any of the areas to have certain facilities close down. Did this have an effect on the morale of people?
- WB: I don't believe so. It was a relatively small force in the overall situation, so they were just absorbed into other facilities – Separations and Reactors.
- MS: When were the first batch of towers closed down?
- WB: Got me. See, I had no involvement directly with D Area by that time.
- MS: When did you get out of D Area?
- WB: I've got it in my notes somewhere, and it will finally be in my book. Let me just make a guess.
- MS: Yeah, just approximately.
- WB: Somewhere in the late '50s or early '60s. Somewhere along in there.
- MS: At D Area, while they were closing down that part of it, was there a feeling there that maybe among the workers, perhaps they had done too good of a job, and that's why they were –
- WB: I wouldn't think so. See, firstly, the lower level workers, it was just a good job with Du Pont. And probably if they saw something closing down, that would be bad. And the D Area guys wouldn't have been trained to be reactor operators and so forth. But it was a relatively small number of men compared to the – generally, Du Pont never made a policy of hiring and firing. They liked to hire people and keep them. So I'm sure they hung onto them as long as possible.
- MS: Right, that's certainly my feeling, just based on people I've talked to. Even at lower levels, if you wanted a job, they probably would make some accommodation for you. If you were supervisory, you just got transferred to something else.
- WB: Or finally left in Aiken (laughs). See, a lot of them were fairly senior people. I retired in 1974, and by that time, I had 34 years Du Pont service.
- MS: Just out of curiosity, back in the early days, was it more prestigious to be living in Aiken or Augusta? Or did it make any difference?
- WB: I felt it was more prestigious to be living in Aiken. You see, when we got here, there were very few places to rent, live, or buy. It was almost all new buildings. When I first got to Aiken, that was one of the things I had to do - see where there was, where we could – I knew there was not anything to buy. And, so I found that two men, Bob Lance and Art Morrey, who were Hanford alumni, had found a strip of land over off Whiskey Road, just beyond Palmetto Golf Course, and had divided this into six acre and a half lots, and each of them had taken one. And I don't know whether it was Lance or Morrey that I got talking with, but we went out and looked at it, and we decided that number 905 would suit us just fine. We bought the lot. At that time, it was just a wooded area. As it turned out, it developed into a very interesting community, very pleasant. We had a very pleasant life there.
- MS: How long did you live in Aiken?
- WB: I lived there until 1990. My first wife died of leukemia in 1986. Then I remarried, and my wife had lived in Augusta for some time. She was director of patient relations, and that sort of thing, at MCG. We did some traveling and so forth, and finally I think this place was being built, and we said that maybe that's what we ought to do so that we wouldn't be a burden on our children, we could live here the rest of our lives. So here we are. Now she's in the nursing care wing here, and I'm holding fort here. That's why we've got such a big apartment.

- MS: Yes, this is spacious. Quite nice. Anyways, going back to D Area – of course, D Area was different from the other production areas in terms of what it made there. But did it have its own personality or quirks?
- WB: I don't think so. I think the Du Pont policies and so forth were the same everywhere, so there wasn't much room for developing that sort of difference.
- MS: I remember, I interviewed somebody one time, and they said that, perhaps in later years, but when Du Pont was still there, there were an awful lot of people who worked at the R Reactor that tended to come from the Barnwell side, because it was closer to where they lived, so that might have been true also for D Area.
- WB: I would think that was a figment of imagination, because men worked where Du Pont put them. Now, if they chose them to find a place in Barnwell to live because it was closer, that might be a factor. It wasn't the other way around. In other words, you didn't go there and say "I'd like to work at D Area." You went and said, "I'd like to have a job with Du Pont." You got put where they wanted you and moved around.
- MS: That makes sense. Talking about heavy water technology again, has that become sort of a technological dead end in this country?
- WB: I suppose it has, Mark. Since no heavy water plants are being built. In the United States, there are not any even operated. Now, in Canada, it might be different. But as far as jobs are concerned, there's not much difference from any other kind of large chemical operation.
- MS: What do you think is going to be the future of the nuclear industry?
- WB: That one is easy. Look, and this gets off the subject pretty far, but I happen to be interested in the future of energy in this country. I've got a couple books back here.
- MS: I've got the same one, "Beyond Oil."
- WB: Fifty years from now, we're not going to have any more petroleum in the world. Imagine what it's going to do to all this tremendous build-up of everything based on the automobile and truck. It's going to be a tremendous change. And one thing that nuclear reactors can do is make electricity. And electricity can move people around. They're doing it to a much greater extent in Europe than they are here. Even years ago.
- MS: Yeah, that's true. In Europe, for example, most of the trains are electric now. Even long distance trains, not just street cars.
- WB: Oh yes, all electric.
- MS: We don't have that here.
- WB: Incidentally, my daughter, and she now has a large extended family, lives in Denver. I don't know who is steering Denver, but they have a large program of construction of what they call "light rail," which is just passenger rail, inter-urban, all-around, fast, and smooth. Car-park, you go a short distance to the rail to get on. That's the kind of thing we're going to have to have.
- MS: Yeah, I think that's probably true. To the degree that we have individual cars, they'll be electric in the future. At the very least, they will be hybrids.
- WB: Well, whatever they are, even if they are gasoline-driven, they will be small enough and economical enough of fuel that even if gasoline is 30 dollars a gallon instead of 3, they'll still be usable for short-distance transportation. Even to get you, well, maybe as far as the Atlanta airport.

- MS: But otherwise, I think for general driving, you'll have to rely on electricity. And for that, you'll have to go back to— either we got to burn coal, which is unlikely in the future because of the greenhouse gas issue, and then the only thing left is nuclear energy.
- WB: The other thing I've got is some information on global warming. I've even got graphs somewhere. Until about 1900, global warming was going like this. 1900, it started going like that. What happened in 1900? Petroleum was discovered. Now, we're almost done. So that will be self correcting when petroleum is all gone. Global warming, if it causes any trouble at all, which nobody really knows.
- MS: Yeah, we don't really know what the global ramifications are going to be. But I suspect we'll just keep using oil until we run out.
- WB: Sure, nothing else –
- MS: Because oil, for all of its faults and everything, for that much oil you get a big bang for the buck. For coal, you've got to have this much.
- WB: And coal is so dangerous too.
- MS: It's dangerous, and it's got not just the greenhouse gas stuff, but the mercury that is in the coal. Not good. So I think nuclear energy will have a second life in the near future.
- WB: It's life hasn't begun yet. Incidentally, people will say "Well, aren't we going to run out of uranium?" It turns out, Mark, that by far the greatest share of the world's supply of uranium is in the oceans. And the Japanese, who aren't so dumb, have developed a very good ion exchange process for recovering deuterium, D_2O , for recovering uranium from seawater.
- MS: So you're talking about that uranium is actually dissolved in sea water?
- WB: Yes, it's in the water! So then, you have no problem with mining. You just put something out along the Gulf Stream and let it come by.
- MS: I didn't know that uranium was actually in the seawater.
- WB: Oh yeah. By far the largest fraction of the total supply of uranium is there.
- MS: That will keep us busy for a while.
- WB: Much longer than you or I will be around.
- MS: Well, that covers all the questions I brought to ask, but if there is anything else you want to add, please feel free to do so. We've already gotten off the subject, so we can do some more of that.
- WB: Well, you speak of artifacts, for example. Well, I've got one right here. It's a damn good bookend. That piece of wood came from the old Ashley Plantation house on site. At the time I got hold of that, it was a big piece, I was helping Girl Scouts in Aiken with their camping committee or something like that. I was helping with building a cabin out at Camp Cofetachakee, which is outside of Aiken. I don't know whether it's still in operation or not. Sarah Bowman, who was the Scout director— we always had been close — we decided it would be nice if we could get a piece of timber. Oh, there was, on the property, the Ashley Plantation. It was down in the direction of Barnwell, out that side of the plant. Actually, the Ashley's had two daughters — Clarice, and I forgot her sister's name — but Clarice worked in Health Physics at the plant. Sarah knew her and asked if there was any way we could get a piece of old timber from which we could make a mantle piece. So that was arranged. Left over from that construction was this piece of wood. I decided that would make something. Well, at that time, I had a larger piece, and I couldn't find either the center of the series of [tree] rings or the outside. But, I did the best estimate, and I figure this tree had

germinated probably about when Columbus arrived in the New World. And this rock, that was a section of one of the core drillings that they did under the plant to find if there was a formation in the rock down there that might be suitable for long term storage of the reactor waste.

MS: Was that something they did early on?

WB: No, this was all through the – this was under the direction of the U.S. Geological Survey, and outside geological experts, and planning and analyzing the information, and planning the work. Well they found this formation, and they found some water. This was one of the original interstices of the rock, and they found water down there that had been there for 10,000 years. They could tell by isotopic dating and so forth. So then, they said well, “That’s a place you could safely store waste.” And Du Pont then called in more outside consultants, and they all said, “There’s one more thing to do. You need to actually put down a shaft so you can get men down there, and you need to drill a tunnel through the rock so that you know you’ve got a big place.” Well, about that time, somebody like Strom Thurmond or so said “No! No!” Well, Du Pont couldn’t fight the politics forever, so they quit and went to the vitrification process, with Corning Glass.

MS: Yeah, that’s a sort of theory I guess. All that stuff will go out to Yucca Mountain.

WB: Oh, I don’t think it will go anywhere.

MS: Whenever the politics can sort it out.

WB: See, the only thing that’s there now [in the waste tanks] that is of any consequence is – they’ve already separated the two baddies, strontium-90 and cesium-137, and they got together with Corning Glass engineers and scientists and developed what was essentially Pyrex glass out of the cesium and potassium. People say, “Well, you’re packaging it in glass.” No, no, it is glass. And that has two cylinders out there. You could walk right by them, because they are low energy beta emitters. They have half-lives of around seven years. So, every seven years, there’s half as much radiation.

MS: Do you think it’s just going to stay out there then?

WB: I think it will be out there forever.

MS: Well, in theory, I guess they’ll put something in Yucca Mountain, whenever they get around to it.

WB: Well, see, as I understand it, the block is not the people out there, but states that won’t let it be carried across their state lines to get it there.

MS: Well, that could be true too. But I think the governor of Nevada said he wasn’t going to admit all that stuff there, until – over his dead body, or something like that. But they didn’t mind taking the money to build the facility.

WB: Oh, my. Oh, politics.

MS: Well, thank you very much. I appreciate it.

WB: So, someday, I might will this to somebody out there.

MS: Yeah, that’s true. Will it to the museum.

WB: For now, I can’t do without this.

MS: Yeah, a bookend is, it’s hard to find a good bookend.

WB: There’s another artifact that they gave to me when I retired, which is a scale model of a Savannah River GS unit. These are the hot tower and cold tower, and the upper stage towers. These are a couple incidental strippers, or something like that.

- MS: Wow, that's pretty nice. These come out?
- WB: I think they do. They were made in the shop out there at taxpayer's expense.
- MS: I imagine that much was. That's pretty nice. And I see you've got the Du Pont dollar.
- WB: Oh yeah, my dollar. And the plate. You seen one of those before?
- MS: Um, maybe not. I don't know.
- WB: I think each of us got one of those. See, that's an outline of the plant area. Here's the Lower Three Runs [Creek].
- MS: Right, that's it. Savannah River, CMX/TNX, D next, the reactors, the separations, Z and S, and A area, and Par Pond, and the railroad yard.
- WB: And the other thing- you know more about it than I do any more- but the other thing that I am distressed that never gets in the newspapers is - I gave a talk here at Brandon Wilde two or three years ago about the plant, and it was a book review. I had given one shortly after the book was written, and a friend said, "Will you do it again?" I said, "Nonsense. Nobody wants to hear a book review twice." But she said "Well, we've got a lot of new people." So I told her I would think about it. I got in touch with Mal McKibben, and I said, "Mal, is there anything new I can say since I wrote that book?" He said "Oh, yes! It was Dixy Lee Ray, who was head of DOE. When she came in, she started declassifying stuff right and left. So there's lots of stuff declassified." So he sent me a whole bunch of stuff, including a book about that thing, which I've still got. If you want a copy, you can have it. It just spins its wheels and doesn't say much of anything. Someone outside was hired to write a book. Never mind the fact that this one already existed. So, then I suddenly remembered, I said, "Gee, I remember when they were building the plant, they started planting pine trees." I remember when they planted the one hundred millionth tree. They used to be lined up in front of 703-A out there. I think they cut them down some years ago. I said, "I wonder what happened to those." So I asked Mal if he knew anyone in the U.S. Forest Service who could shed light on it, and he said he'd look into it. So here, he said, "Well, there's a woman out there whose last name was Cokenhauer. I'd like to say her first name is Juanita, but I'm not sure." She said she would bring me some information, and she did. Well, I may have something relevant here on that. (rummaging) Yeah, if you want, I will let you borrow this. But I want it back. But this is as of the end of fiscal 1963. By that time - now I'm just giving these numbers off the top of my head, I think most of them are in there. But it seems to be that when they bought the plant, when the government bought the plant, they paid about eighteen million dollars for it total to the landowners. And, first thing the forest service did when they came in was to appraise the value of the standing crop of trees on site. They concluded they were worth twenty-three million dollars. But then they started planting trees, and by the end of 1963 they spent, I think- I don't know how many million dollars. But they had also sold, I think, eighty-three million dollars worth of timber. And they estimated the value of the standing crop at that time as about five hundred million dollars. Now that never gets in the Augusta Chronicle. All they look at is the number of people working out there.
- MS: That is true. That's always a big issue, I would imagine. What's the employment level.
- WB: The point is that they're not making anything.
- MS: Right, they're processing tritium.

WB: When we finished running the plant, the peak force with five reactors running had been two thousand people. Now, it's oscillated around fifteen to twenty thousand people. I don't know what it is now.

MS: Well, some of them are involved, of course, in the remediation stuff. But who knows what the others are – at that point, maybe we better turn this off.

WB: (laughs) We probably should have turned it off sooner.

MS: (laughs) Well, that's true. I'm going to shut this thing off here.

END TAPE

NEW SOUTH ASSOCIATES – INTERVIEW WITH
MITCH BURGESS

Interviewee: Mitch Burgess

Interviewer: Mark Swanson, New South Associates

Date of Interview: November 14, 2006

Mark Swanson: This is the 14th of November 2006. This is an interview with Mr. Mitch Burgess. If you would, Mr. Burgess, state your name and your affiliation with Savannah River Site.

Mitch Burgess: My name is Mitchell A. Burgess and I was working for the Film Department in Iowa for DuPont. The Plant, like other plants, were giving a quota of the number of the people that they needed to do these jobs. That was in 1952. I was checked out by the FBI and then transferred down here in July of 1952 in construction-checking first, then was assigned as a process supervisor over technical people, other engineers.

MS: So if I've got this right, you began at the plant in July of 1952?

MB: Yeah.

MS: And was that in the 400 Area?

MB: Yes.

MS: Okay. How long did you work in the 400 Area?

MB: 17 years.

MS: What was your affiliation, if any, with the Dana Plant?

MB: With who?

MS: The Dana Plant?

MB: No affiliation. I, of course, talked to the people at Dana.

MS: What was the nature of the connection between Savannah River Site and Dana?

MB: Well, a lot of the people came from Dana. They transferred to 400 Area- and 400 area and then the laboratory, SRL [Savannah River Laboratory].

MS: Just for the record, what was the nature for the GS process that they used at Savannah?

MB: It was published in the physical chemistry books, so it was a standard process and we knew that the process worked, but we ran a Pilot Plant at Dana. The Pilot Plant had to apply (inaudible) in the iron because it was made of flamed iron steel and was (inaudible) [lots of dog noises].

MS: We have a dog interlude here.

MB: The process was a standard process and we knew that the process worked, but the pilot plant at Dana failed because it choked up with iron sulfide. They had a small pilot plant, you know like a standard pilot plant. So we started the Dana Plant and we started the 400 Area plant. But other than that, it was the Pilot Plant. There were great sighs of relief when the concentration of heavy water started integration.

MS: So both began really without the benefit of the pilot plant.

MB: Yeah. It was too late, if you recall, there was a great deal of pressure by the administration, by the United States Administration, to move forward with this because it was Cold War conditions.

MS: Right. When was this, that the pilot plant at Dana failed?

- MB: I think it was about either 1950 or 1951. I wasn't there. But the design by Thayer and Bebbington were well under way.
- MS: To the best of your knowledge, when was the 400 Area built?
- MB: It started in the spring of 1952.
- MS: When was the 400 Area phased out?
- MB: 1981 or 1982. I'd left and retired by then.
- MS: Didn't they start tearing some of the facilities down even in the '50's?
- MB: Yes. Oh, not in the '50's, maybe at the very end of the '60's. That really wasn't tearing down; that was simply shutting down.
- MS: Okay.
- MB: And of course the installation sagged and all that when the plant wasn't running. I think it was really before. It was some time in the '70's when they shut some of the facilities down and then the installation started sagging.
- MS: Did the Savannah River Site always get its heavy water from the 400 Area, or did they get a lot from Dana?
- MB: No. Well, what was made at Dana certainly wasn't thrown away. We were very cost-conscious. We tried to make the heavy water at the minimum cost per pound. Some say we spent \$50 per pound. It depends on what cost you're speaking of. The out-of-pocket cost was about \$36 per pound.
- MS: How often did they have to replace or replenish heavy water for the reactors?
- MB: Oh. That I don't know.
- MS: Where did they make heavy water aside from the Savannah River Site and Dana? Did they make it at other places?
- MB: They made some of it at the Manhattan Project, but that was before my time too. When I saw the plant on the Manhattan Plant, it was rusted and it was shut down long since. It was a pure distillation process.
- MS: How many people worked in the 400 Area?
- MB: Gosh, I don't know for sure. We had about 8,000 in the whole plant. In the 400 Area, I don't remember the number.
- MS: What was the main safety concern in the 400 Area?
- MB: Oh. Gas. H₂S gas. Not radiation.
- MS: Right. Was it one of those deals where they added something to the gas, or if you just smelled it, you knew there was a problem?
- MB: If you could smell it, it was all right. If you couldn't smell it, boy, you'd better run!
- MS: Oh. Okay.
- MB: Because H₂S deadens the sensor nose above 2 percent. As soon as the gas gets above 2 percent, you'd no longer smell it.
- MS: So, as long as you smelled it, it was okay.
- MB: Yeah. As long as you smelled it, you'd better run anyway.
- MS: Yeah, well that's probably true. Were there ever any problems with gas leaks?
- MB: Well, we had a couple of guys collapse because they couldn't smell it. But we had the "buddy system," and no one had any permanent injury.

- MS: So if you worked there, you had to have a buddy with you at all times.
- MB: You had to have a buddy when you went into the GS area. There were several cases where the buddy went down and the "buddy system" worked because they turned in alarms and somebody came up, picked him up, carried him to a corridor(?) and the guy recovered right away.
- MS: Did that happen very often?
- MB: No. Very rare; so rare that any time one happened it was a big thing. There'd be a big announcement.
- MS: What was security like in the 400 Area?
- MB: It was very tight. During the first days, all of the data was secret and we used a classified notebook to do calculations and everything, so it was tight.
- MS: Was there a, like a perimeter fence around....?
- MB: There was a perimeter fence around the whole area, of the 400 Area, and then a barricade around the GS tank, the storage tanks where our liquefied hydrogen was.
- MS: What was a typical day like at the 400 Area?
- MB: Well, you'd come to work in the morning; we went home at 4 o'clock. We'd eat at noon. In the meantime we worked out calculations or procedures. A great deal of work went into procedures.
- MS: When you say procedures, is that?
- MB: Written procedures.
- MS: The way you used to do something safely?
- MB: That's right. And the way to do it successfully.
- MS: What kind of procedures would those have been?
- MB: Well there were check sheets, where a guy would initial having done something.
- MS: So that'd be like, as a rule though, what did you have to do, like just check all the machinery to make sure it was running properly?
- MB: No. We'd do the procedure. We would do, there were different things that we had to do and we'd read each of the items very carefully and as a work assessor, we would review all of the procedures, every one in detail, and the production people would review them in detail. The Health/Physics people would review them in detail. Then finally, we had to approve what the guys did. This is a for instance: the H₂S stripper, which took the heavy water, you know the light water that was waste went to the stripper and the H₂S was stripped off. So then, when it went eventually to the outfall, the water was well stripped from the GS units. Then the waste water went over a number of dams so that the waste water did an additional stripping, and they sampled the river up and down regularly.
- MS: Just out of curiosity, how much D₂O would have been produced in a day?
- MB: What?
- MS: How much heavy water could have been produced in one day, or do you have a figure on that?
- MB: I probably don't remember the number right off hand.
- MS: Was it a lot?
- MB: Well, 55 gallon drums.
- MS: They were all stored in 55 gallon drums?
- MB: Yeah.
- MS: You don't remember how many 55 gallon drums were produced?

- MB: No.
- MS: Per day or so?
- MB: I did at one time.
- MS: Talking about eating lunch, where did you all eat lunch? Did you ...?
- MB: We had a cafeteria.
- MS: Where did they bring the food from?
- MB: They cooked it there.
- MS: They cooked it there? Okay. I've always heard that people in the 400 Area had social connections, I guess, with the people in CMX/TNX because they were both kind of on the river and
- MB: Yes. That's true. We knew them and they knew us.
- MS: Right. Let me ask this: when did the Dana Plant close? Do you have any idea?
- MB: I didn't work there, but I think it was, it was after '52. I would guess. I'm guessing now. I would guess about '55. Do you know Bill Bebbington? Is he on your list?
- MS: Yeah. I think that Mary Beth Reed has interviewed him before and I think she's going to interview him again for this particular study.
- MB: Who was that?
- MS: Mary Beth Reed, she's my boss, and she is sort of in charge of this particular project. We had- was it last weekend, the weekend before last- we had a little get-together up at Ruth Patrick's Center University of South Carolina, and Bill Bebbington was there.
- MB: How old is he? He must be 90.
- MS: To be honest with you, I didn't see him up there that day because I was interviewing somebody else, but Mary Beth talked to him and Cy Banick brought him to the program from Augusta.
- MB: Yeah. He lives in Augusta.
- MS: That's all I heard, but I think his wife is ill. I think he's in pretty good shape.
- MB: Yeah? Good.
- MS: Yeah. I heard he was there. I wouldn't recognize him. I only know about him because of that book that he wrote on the DuPont and Savannah River Site.
- MB: Yes.
- MS: That was a few years ago. Out of curiosity, out of all the heavy water that was used at Savannah River Site how much of that heavy water was produced in the 400 Area, almost all of it?
- MB: No. Nearly all.
- MS: Okay.
- MB: Well we had a quota and when we completed the quota, the reactor was shut down. We sold quite a bit to Canada.
- MS: That would be an interesting connection, because Canada, of course, used a lot more heavy water in their commercial reactors, I guess.
- MB: Well they built a plant in Nova Scotia, but other people could tell you more about that, like a guy named Garvin. Is he on your list?
- MS: He's on my list, but I've had a hard time getting a hold of him. The numbers I've got are wrong. I've been getting a wrong Robert Garvin.

MB: How about Schroder, Mal Schroder?

MS: I think he's gone.

MB: Oh. Is he dead?

MS: Let me get my little list here.

MB: You know there's almost nobody alive.

MS: Yeah. I talked to his son, Ron, and he said that Mal died three years ago. Then I talked to the daughter of W.C. Scotten.

MB: Oh. Yeah. Bill.

MS: He's passed on. I've heard that Bill Morris has passed on, but I don't know that. I heard that he was in Dana and 400 Area.

MB: That's right.

MS: I'm going to talk with Don Duarte, I'm hoping, tomorrow.

MB: Who is he, Don who?

MS: Don Duarte. It's spelled like Duarte. He lives in Augusta. Don S. Duarte? Donald Duarte?

MB: I'm not sure about him. I don't know him.

MS: He may have been later. But I haven't talked to Lee Poe yet. I've left him messages on his machine, but he may be out of town.

MB: Yeah.

MS: Anyway, as far as Robert Garvin is concerned, I had a couple of numbers. One was in Aiken and one was in North Augusta. Both of them turned out to be wrong; the wrong Garland.

MB: Oh. I see.

MS: Do you have a number for him by any chance?

MB: I wouldn't have anything that wasn't in the phone book.

MS: Yeah. That's where I got this.

MB: It's Robert G. Garvin.

MS: Robert G?

MB: G like in George.

MS: I probably got the "S" from somebody else. I usually look it up under "Robert Garvin" because

MB: Yeah. You're not really sure.

MS: Hopefully we can get a hold of him and there's another person by the name of Gus or Thomas Kotti?

MB: Yes.

MS: He worked at Dana too, but he did not work that much in the 400 Area apparently, but I need to, and I don't think he's got a phone machine so I need to call him again. That's the status so far. As far as the 400 Area goes, if there is anything else that you want to add about the time you spent there or anything else about that area.

MB: Process control was a problem with that process, because you were very subject to the liquid-to-gas ratio in the tower and I'm surprised that the guys did as well to start up. We didn't have any way of telling the production [about adjustments] because by the time we'd run the final process it was way too late to

make any daily adjustments. We finally developed a computer for our system to calculate the production rate when you wanted to do that. It was called A-Q-U-A, "Aqua." Bill Bebbington had a little chart on his desk that showed the L/G [liquid-to-gas] versus production rate. They were like a curve like that. The second series were the other direction; so we had both curves and he melded them together to find out the maximum rate. We used that to calculate the production rate, and used it for process control. We could run that program at about 10 minutes. Probably about 10 seconds an hour later.

MS: When did this AQUA computer come in?

MB: Gee, I think it was, certainly in the 1960's or 70's. I wrote a paper on this thing, and there's a paper in the AIChE Journal.

MS: Okay. What was some of the other major problems that were- things that had to be worked out in the 400 Area?

MB: The operating procedures probably; the detailed operating procedures.

MS: Yeah. It could be pretty deadly to work there, so I guess if you didn't do it right, it could be a problem.

MB: Yeah. They had one fire, as you know. I forgot what the date was. But two of the 16-inch pipes that were joined with a screw nut. We pulled the two of them together and they didn't separate. Over time it stretched a little. Every time it would shut down, we had to tie it up. It did stretch a little and by the time they opened it, that flame went something like 400 feet in the air. No one was hurt. That's where our check sheets and procedures came in.

MS: Okay.

MB: Scared a lot of people

MS: Right.

MB: There was a guy named Tally Crocker who was- I don't know if Tally is still alive. I've lost touch with him entirely. But he was the main fighter in that fire. He stood right up there and faced that fire and gave people equipment and directions, and when the thing was over, one of the operators asked him if he wasn't scared, and by then the realization of what he had done had set in. He told him he sure as hell was scared.

MS: Right. Yeah. I could imagine. Was this in the '50's when this happened?

MB: No. Let's see, when did I leave? I left pretty close to '70. I was living here at the time because I was still working while I was living here. I had transferred I think before I was in the 400 Area and then went into H Area and then F Area. (inaudible).

MS: You said you left around 1970. Was that Savannah River Site altogether?

MB: No.

MS: Just 400 Area.

MB: Yes. Just 400 area. Now, we went from 400 area to H.

MS: I'm sorry. When did you leave Savannah River Site?

MB: 1981.

MS: 1981. Going back to that GS process, just real briefly just for the record, if you would described, just in general terms, what actually happens in that GS process. How you get heavy water from a huge volume of light water?

- MB: [Heavy water in] Light water was very low and little in concentration and so it was fed to the top of the cold tower and then it concentrated, as the H_2S came up, bubbles through it. Then it went to the hot tower and they stripped heavy water moved forward so that at the junction, heavy water was extracted. Then it ran to another stage that did the same thing at a cold tower and a hot tower and at the junction we got very high concentration, around 99-something percent. Then we had to further distill it with a distillation process and we did that in stages to concentrate it to 99.5. So, yeah, you had keep it going.
- MS: How long would it take to do that at that level of concentration?
- MB: Oh, I would guess, it'd be just a few minutes to go through the first stage and a few minutes to go through the second stage, and then it was taken it over to the DW process, which was a distillation process. It's been a long time; it's been how many, 35 years and I may not have some of these numbers right.
- MS: Oh, that's fine. That's just the general idea of what
- MB: Yeah, but I think we got it up to 95 percent in the GS process. It went from 95 to 99 percent.
- MS: So the GS process would get it up to 95 percent, right?
- MB: Yeah.
- MS: Okay. Is there anything else that you want to, that you can think of that you want to add or mention about your years in the 400 Area?
- MB: No. I was a chemical engineer and mostly I processed control work for chemical engineers, and I think my working with DuPont either there [SRS], or the commercial plant before I came there, was a very lucky decision because when I left school there was a great demand for chemical engineers, and you could have had a choice of about 10 jobs. And just by luck I picked DuPont.
- MS: If you don't mind my asking, when and where were you born?
- MB: Fargo, North Dakota. Mostly raised in Minnesota, up near the Canadian border.
- MS: When was this?
- MB: 1920.
- MS: You were born in 1920?
- MB: Yeah. It's been 25, 26 years since I worked at the plant. So that's a long time.
- MS: Where did you go to school?
- MB: Warroad, Minnesota, High School, and the University of Minnesota.
- MS: I can't think of anything else that I need to ask at this junction, but if you want to add anything else or if there is anything else you want to mention?
- MB: No.
- MS: Well, if that's the case then, thanks again for the interview.
- MB: You're welcome. Are you going to see Bebbington again?
- MS: I probably won't, but I think Mary Beth said that she was going to interview him.
- MB: Okay.
- MS: Hopefully that will be, it probably won't be this week; maybe next week or something.
- MB: If there is some way that you can contact her, send my greetings to Bill Bebbington.
- MS: Okay, sure. Yeah, I think that Cy Banick sees him on a fairly regular basis. Like I said, I think Mary Beth is going to be interviewing him as well, and that's the story I heard. I'll certainly pass that on.

MB: All the guys that I knew that had Dana experience, like Bill Morris, Bill Scott, and John Procter, and Rick Thayer. They're all dead. Bebbington, of course, I think he's the lone survivor that I know of, that was (inaudible), and of course he was (inaudible) at Savannah River Site.

MS: Okay. Great. If that's the case, thanks for the interview and I'll go ahead and shut this off now.

END TAPE

NEW SOUTH ASSOCIATES – INTERVIEW WITH
DON DUARTE

Interviewee: Don Duarte

Interviewer: Mark Swanson, New South Associates

Date of Interview: November 15, 2006

Mark Swanson: This is Mark Swanson on the 15th of November, 2006 and this is an interview with Mr. Don Duarte. Mr. Duarte if you would state your name and affiliation with Savannah River Site.

Don Duarte: Don Duarte. I was a supervisor with DuPont from June 1952 through August 1990. I'm retired now.

MS: When did you begin working in the 400 Area?

DD: I hired in with DuPont in June 1952 and reported to Dana Plant at that time and left there in March 1953.

MS: And you left the Dana Plant?

DD: I left the Dana Plant at that time and reported to Savannah River Plant in April of 1953 and the rest of my employment was at the Savannah River Plant.

MS: How long were you employed at the Savannah River Plant?

DD: From April 1953 through August 1990.

MS: How much of that time was in the 400 Area?

DD: None of it. All of my time associated with heavy water was at Dana.

MS: Oh. Okay. Just for the record, what did you do, what area did you work at Savannah River?

DD: I worked in the separations area; both of them, F and H.

MS: What were they producing at the Dana Plant?

DD: Heavy water. But, as I told you, that was like a Pilot Plant. As soon as the 400 Area here got going, which was shortly after I left there. I'm not sure; it was probably sometime into 1954 maybe, they shut down Dana Plant and they used it as a Pilot Plant. The 400 Area of course learned from it.

MS: I heard that they had some problems with the pilot plant at Dana. Was it correct?

DD: Well, yeah. I got there they had, when I got to Dana they were in the process of starting up the bubble cap towers. That was the first step in the process. All of them were not on the line yet. They were still getting them turned over from construction. I don't know about the pilot plant. As a matter of fact, I don't remember a pilot plant there for the bubble cap towers. I don't think they had one, but anyway, we had problems of course just starting up. Any time you start up a major facility there are problems.

MS: How big was Dana?

DD: They had three major manufacturing areas. There were the bubble cap towers where they took water and through the process, enriched it. I don't know; I was trying to remember, I'll just guess just so we have some figures, up to 3-5% heavy hydrogen. Then it went from there to steam distillation where they, and I'll guess again because I wasn't there long and it's been a long time since. It's probably, I'll say, 90% heavy water. Then they put it through the electrolytic process they took it up, I guess, close to 100% heavy water.

MS: What was the main connection between Dana and Savannah River Plant?

DD: Well, they were both operated by DuPont, under contract with the Government. At that time I think it was AEC. So DuPont, as they did here, hired people like me just out of school and probably some hired

people from other industries. Again, I can't think of any off hand, but they also as they did when they operated the Handford Plant, transferred a lot of people from their commercial plants to there and to here. Some of them they transferred to Dana and to here, mostly to here, where people had operated at Handford for DuPont before. But I don't know if they had any or many at Dana. They were either, well some of them, that part of history I can't remember because I didn't have much time to talk to people and so forth. I was just new out of school and I was getting acquainted and all that.

MS: When did Dana Plant get started?

DD: Well, they were just starting up when I got there in June 1952. They were just starting up the first stage in the process of enriching the normal water and I think, and that was the bubble cap towers, which are of course the major construction effort. I think at that time, of course I wasn't associated with it, but if you can talk with other people and see what their memory is, I think that steam distillation unit and the unit that concentrated by using electricity, I think those were all ready to go. When we got through with concentrating it with whatever units we had operating, the steam unit was ready to receive it and the electric unit was ready to receive from them. So there was no problem on start up that way. That's my best recollection.

MS: You mentioned the bubble cap towers- what exactly did that do?

DD: It would take normal water out of the river and concentrate it up to, like I say as best as I could remember and just to give us figures, from 2-3%. Heavy hydrogen in normal water, and again just figures out of my head to give some idea, maybe five hundredths of a percent. You can check with somebody on that; somebody like Lee Poe. Did you say that you interviewed Lee Poe?

MS: Yeah. He couldn't say exactly. He said roughly this.

DD: Because he was in the technical part. The way they concentrated it was by passing the H₂S gas counter-current to the water. They would do this through several towers. Each tower had, I don't know, say forty trays or something like that and the water would be pouring down from the bottom and the gas would be blowing up through it. And by reaction with the H₂S at each tray, there would be a small amount of concentration, and as the water came down through each tray, it would be concentrated. But, there were several stages: after the water left there- like when it was going through the first stage, it might have only been concentrated at .0055. Then it would go through the second stage and the same thing would happen. That water would bubble down and the gas would be pushed up through it, and it had like 40 or 50 trays. At each tray, there'd be a small amount of concentration and when it finally came out it would overall be concentrated. Then that would pump through the next stage. It'd finally get up to 3-5% and then go to steam distillation.

MS: How long did it take to produce, let's say, a 55 gallon drum of heavy water?

DD: Whoa! That's a good question. Let me see.

MS: Or was it done in such bulk that it just wasn't measured that way?

DD: At the end it was measured that way, out of the electric plant. But, starting in at the bubble cap, these were at least 50 foot high and 6 or 8 feet in diameter. So there was a lot of volume there both gas and water in the initial stages. You'd have to look back because the 55 gallon- if you had a 55 gallon drum of stuff concentrated out of the- and I doubt if they ever came up with. What did they come up with? I don't remember what they came up with because I didn't work in that part. But, it would take enormous

volumes of water initially because the concentration of [heavy] hydrogen was so low that you had to use an enormous volumes to get enough heavy hydrogen atoms to get the concentrated water at the end. I think if somebody were working there now and you asked them that question, I think they would have a hard time with it too.

MS: Also, if it goes through a series of processes—

DD: You see, you start with a very, very low concentration, like below 1% and you concentrate all the way up to 100%.

MS: So you've got to go through a huge volume of water to get that.

DD: Yeah. I mean if you didn't return the water to the Wabash River, it would run dry. I'm just kidding about that, but there was enormous volume of water.

MS: Why'd they put the Dana Plant where they did? Was there any reason—?

DD: It was already there. It was a Government Plant. I think it was a gas plant.

MS: Was it a World War II-facility?

DD: Yeah. Like it something that wasn't good for anybody. I understood that they might have changed it back after I left. I don't know. But, there was already a facility there, but not a manufactured facility. The land was there, you know, so they could go ahead and I don't know, they might had something; well I don't see anything they could have used from—. Like I said I don't know what they did before (inaudible) they made some poison gas. I know that the towers were new, the steam distillation unit was new and the electrical unit was new, so I thought. But the land was there.

MS: When did Dana close?

DD: I think it was— I came down here in June 1953 and they started up and got going good, and I think they closed down, as a matter of fact it surprised me how fast they closed it, but I would guess in 1954, given a full year, at the end of 1954 because what happened, what skuttlebutt I got, is that although Dana solved their problems and was running well, that Savannah River learned from them and was running better. And so, they decided to close it down.

MS: Okay. Did it make any difference in the production; Dana being in a little colder environment? Did it make any difference at all?

DD: I have no idea. I don't know. I never studied it or had any information from that aspect. It might be.

MS: They was something about when it was freezing weather and stuff like that, that they had to go around and knock some ice off of something up at Dana.

DD: Oh. Well, now you know the question I thought was a

MS: (inaudible)

DD: Because a lot of reactions proceed better when it is warm, but those towers— the initial stages, which is the only thing it would make any difference— were heated. By that, they were insulated and had steam tracing (?) on them. The water was not pre-heated, I don't believe. We didn't have any heat exchangers on the line, so the water came in cold but I would think that in that little a short time it wouldn't make much difference. But, what did make a difference is that in the winter time you had to worry about ice on the [towers]—see, you had to climb to various stages of the towers to get sample points. So you had to climb the various stages of the towers and if it rained or snowed or whatever, you know open grating gets pretty dangerous. That was one of the safety things that.... As far as the process, I don't really know

but if I had to guess I would say that was insignificant. I think what they did, and I'm guessing, is that they used that as a pilot plant. They got it going good down here and then they had heavy water right here. Because they had to recycle, when it went through the reactor once, they had to recycle it. So they had the facilities right here. There's no use having a facility here and a facility there. This was— although the Dana Plant got operating pretty well; they resolved the problems. From the things that were learned there I understand they made changes in the process down here and in the equipment. So, it [400 Area] was a better place to work.

MS: How much bigger was the 400 Area than Dana as far as production?

DD: I don't think it was any bigger.

MS: Oh. Okay.

DD: I don't know. I've only visited the 400 Area, but from what I saw, it wasn't much bigger. You know when you worked out there, you didn't travel around the plant. So you actually didn't see much. The only time I would get to see the other [parts of the] plant is if I went to TNX which is in that area, or later on, when I was at the end of my days and wasn't actually in production, but doing work on construction, checking, that I got to travel to parts of the Plant for various reasons. But, I don't think it was any bigger. Dana had the bubble cap towers; they had several stages and they had several units. That was the biggest part of any plant, was the bubble cap towers. So my guess is not much difference, but I don't really know.

MS: Okay. Talking about Dana and everything, where did people eat there? Did they have a cafeteria out there?

DD: Yeah. They had a cafeteria. Most of us just brought lunches or a snack. I can remember bringing just a stick of pepperoni which didn't taste too good on midnights. That's ok. I can remember on days— there was a guy there who hired in—.

MS: How many people worked at Dana?

DD: I have no idea. I don't know. There weren't

MS: Are we talking about hundreds or thousands?

DD: Oh, no! Well if you take a look at when we first started Savannah River Plant, which was the 400 Area which was the 300 Area, the 200 Area, the reactor areas, we were talking about 5,000 people in operating. I would estimate that, well let me see, I would say an outside figure would be 500 and I would include everybody in that, including maintenance and operating.

MS: What was security like at Dana?

DD: I don't remember much about it. I don't think there was hardly anything to it, because that was in the early days and when it came to the Savannah River Plant it was about the same way. All you had perimeter security. You didn't have any area security. You just passed through a check point and that was it. I think that's about it for Dana. I don't remember guards going around or anything like that.

MS: What was, and I probably know the answer to this, but maybe we can put it on record anyway, what about the gas smell? That was the big safety issue at the 400 area, and at Dana too.

DD: The big safety issue with the gas is that if you sniff enough of it you don't smell it.

MS: Right. So if you don't smell it, you're in trouble.

DD: Well, if you smell it you'd better get out of there because you're going to get to the point where you won't smell it.

- MS: Oh. Okay.
- DD: It's H₂S, you know, that's rotten egg. It's a heavy gas and it lies in low places. So if you go along a ditch, that's the worse place you can get it. If you go in a closed area, that's the worse place. If you got a wind blowing, that's good. You know the way it works. It's a gas that paralyzes your olfactory nerves, and so if you sniff it long enough you won't smell it and you can get it in a heavier concentration and not know the difference. If you initially smell it, that's the time to get out of there where you can't smell it. While I was there, they had a couple of guys that got enough so they passed out from it, but there were no fatalities from that; they took them to First Aid and that's it.
- MS: So, there wouldn't be any lasting side effects or anything?
- DD: Oh, there would be. You could die from it.
- MS: Well if you recovered, would there still be some side effects?
- DD: I'm not a doctor. I would think that it depends on the severity of how much you had, and how long you did it. What it is, you don't have any oxygen. And with your brain you have three minutes. So it depends on where you were and how much a snootful you got before they started pumping oxygen into you. So it could result in death and I'm sure since it affected your brain and your nerves, it could have affected any part of your body, or brain-related--.
- MS: What were some of safety measures they took to prevent that kind of an overdose?
- DD: Of course the first thing is containment. You got to keep the stuff where it is. If anything leaked, you had to get it replaced right off the bat. We carried around masks, that's what I remember, and there were also Scot Air Pak stations throughout the facility. Then you had drills, you know, trying to respond to whatever was going on. I think they had teams of guys set up.
- MS: Did they have weekly safety meetings?
- DD: Oh, sure. I don't think weekly; that's not DuPont. I jumped right in there-- because what I remember is that it was monthly. You always have everything you do when you work for DuPont, when you read something, there's some safety note there. As a matter of fact, all procedures start out with safety; wear your mask or carry it or whatever.
- MS: Right. Were there a lot of people who once they got there decided they couldn't take the work because of the smell? Or did it smell always?
- DD: Oh, no. Like I say you didn't want to smell it always; so, no. You know people make fun of the smell because it smells like something else besides rotten eggs. But there was not enough of it around because it was dangerous, so you very rarely smelled it.
- MS: But if you could smell it, didn't it trigger some kind of alarm?
- DD: You know I don't remember that, but I would think they would have some alarms from that. I can't remember exactly but they should. Of course one thing that was bad about it, it's a heavy gas. So if you're going to have something to sniff it, it would have to be down low. So I'm fifty-fifty on that; I'm thinking it'd been a good idea to have it but I don't know if they had it or not. If I had to go on one side or the other of fifty-fifty, I would say we depended on doing things right so that we didn't have any problems. Then if something happened; I don't remember this. There must have been call alarm stations. I know there were telephones throughout the facilities where you can get emergency response teams in

there. It would include people who were trained and would include firefighters. When I mention that, I'm not certain that we had a fire department there, but we must have because it's a combustible gas.

MS: Where did you all get the hydrogen sulfide?

DD: Well, I was thinking of that. We had storage facilities because when you shut down a unit you have to store it. And then you had a unit for sort of purifying it and upgrading it, and I think we also made it there. I don't remember the reaction, so we had— I know we have storage facilities for it and I know that they would reprocess it and I'm fairly certain. Because if you use something over and over again, even though you try containing it, part of it is going to go out with the water and will discharge into the creek after it leaves there. So yeah, small storage tanks and, I think, a small operating facility. I know they had a small operating facility.

MS: What was a typical day like at Dana?

DD: For me it began in "Terrible Haute," Terre Haute, Indiana. I stayed there in the "Y"; I was single and just out got out of school, so I stayed there. I didn't have a car and I got picked up, and most of the time I was there I was on shift. Shift work is reporting in 10 minutes early and getting a turnover and then going about your business. We had a control room watching what the charts told us. Then you might have something to do in the facility; like, you might have some maintenance that you'd have to go out and follow or point out what had to be done when we were there starting up the units. It was just regular production work. Get your turn-over, find out what had to be followed up and then when things came up, make sure the process was running right and keep up with maintenance, whatever. Of course, days were the worse time. When you rotated on shifts and you came on days and everybody came in when you did and unfortunately you had everybody telling you what to do. Nobody who works shift work likes days for that reason. There were always the chiefs there telling you what to do. You know it's just an added thing; part of the job. But when you're on shift, you got one guy telling you what to do, and you do that, and then there were other things. If you were on days, like Lee Poe would come up to you. He was in what they called the [Reactor] Technical group. He would ask you questions. So he had additional people talking to you. That's just what happens all the time in every plant, no matter where you are.

MS: Right. The supervisors are going to be there during the day; not at night.

DD: That's right. That makes sense.

MS: Of course then you've got to stay up at night.

DD: Oh that was always fun; no, not really. Especially— part of time, see I was hired in June so I was there through the winter and you have snow and icy conditions [at Dana]. When you travel, I think it was about 40 miles, it can be dangerous and plus that, there's always a danger at midnights when you're coming home. The driver, guys try to stay up and watch the driver, but they fall asleep. So it's up to the driver. Sometimes it's pretty scary for the drivers, trying to stay awake.

MS: I know you said that you didn't work in the 400 Area, but if you would just for the record just to sort of round out that aspect on it; where did you work at Savannah River Site

DD: Well I got transferred down here in April 1953 and reported directly to 200-F. 200-F was building then. The only permanent building that were really built then were 717-F, which was the maintenance area and the reason that was build was because Construction used it for various reasons. Then there was

the Lab building, the concrete building was built, and then Building 235 was built, and of course, the powerhouse. The rest of the buildings were being built, like 221-F, they were just pouring it.

MS: Yeah, there would have been a lot of pouring.

DD: You're telling me. The guy that had the contract was a Polish guy; he wasn't in the concrete business, never was in concrete business, didn't have a concrete business. He bid on it and used the money to buy the trucks and the concrete mills and became rich. Because for instance I think even the roof of 221-F is like four feet—I know one side is five feet. What happens is you just pour concrete all over the place. It was a lot of fun. You walk up there to walk up there and the workers were putting in re-steel and then they'd swing a boom up there and they'd pour concrete up the side of the building through a big pipe. So it was pretty interesting.

MS: I guess they had everything pretty much finished by 1955, 1956.

DD: Oh, we started up in 1954. I think late 1954. Our Building 221-F, we received hot fuel from the 100 areas. So, it was in 1954 and I would think it was late '54. I got there in early 1953. I think it was in the fall of 1954 when everything started up. Would you like to look in here [pointing to book "Savannah River Site at 50"].

MS: I can easily believe I forgot that. (Inaudible, talking over each other) What about after that?

DD: What do you mean by after that?

MS: Did you go anywhere else?

DD: I stayed in F Area and H Area. I started off in Construction, checking in F Area, and then I was in A-Line, which handles the uranium. Then later on I went down to 211-F which handles the cold-feed, you know like the chemicals, the nitric acid, and stuff like that. Then they also handle low-level waste there. Then they had a stage where they rotated operating 221-F and 221-H. We would operate 221-F for a while and then go over to 221-H and run it. Because 221-H ran different fuel than F did. Then along the way, I was assigned to the HB Line and ran that for a while. Then I was in JB Line for a little while. I ended in 235-F in Production. My last days were spent in design liaison, which is where I started out practically. Whenever they built a new facility, I would interact between the people who were going to operate that facility and the design division. So that was my job until I left.

MS: Did you have any work in the Tritium facility?

DD: No. Never got there. That's about the only spot I didn't hit in F and H area. And I didn't hit the new plant for handling concentrated waste, you know, putting it in the containers, DWPF—that came later on.

MS: I think that started up in the early '80's maybe? They had just broke ground on it in the early '80's and they didn't finish construction until later.

DD: Yeah, and then they had trouble getting it operating. I think they used the plant as a pilot plant because it's pretty hard to build another plant to do that, and they had a lot of trouble getting things ironed out. When I left there, they were still at work in the '90's, so I don't know. But I understood they had some measure of success and that was good. You look like you were a little bit fatter than me. You were younger [looking at the SRS badge].

MS: Oh, yeah. That picture is like, years old. If there's anything else that you wanted to add that I hadn't thought to ask about your experience at Dana, or dealing with the production of heavy water?

DD: I don't know. Did you talk to anybody who worked in the electric plant or anything like that?

MS: No, but I wouldn't mind doing that.

DD: I think that would be very interesting because they had a lot of backfires there; because, hydrogen is a gas, you know, and it just so happens that it's heavy hydrogen, and they would have minor explosions there, I don't mean stuff that would blow equipment up, but they would get big bangs.

MS: Oh. Okay.

DD: But that would be— steam distillation was a pretty innocuous operation, but I think you might get some info, you know. I never been good at names, and I'm worse now than I've ever been. I'm trying to see if they got a

MS: Yeah, I think they should have an index back there for people [referring to the book].

DD: I was just noticing that. They've got one of my bosses. Did you ever hear of Hershey?

MS: I think I've heard the name, but not recently.

DD: He's the guy they should write about. I reported in to him, he's a nice guy, but you know— he's dead now— but he didn't pat a guy on the rear end. He'd kick your butt. He was fair, a real good guy; he helped me a lot. Let's see if they've got my name in here. Nope. They've got Du Pont, but not my name. Can you imagine that?

MS: Just in case it gets spicier than that, I'd better turn this thing off. That will conclude the interview. Thank you.

END TAPE

NEW SOUTH ASSOCIATES – INTERVIEW WITH
LEE POE

Interviewee: Lee Poe

Interviewer: Mark Swanson, New South Associates

Date of Interview: November 14, 2006

Mark Swanson: This is the 14th of November, 2006. This is Mark Swanson and this is an interview with Lee Poe. If you would, please state your name and affiliation with Savannah River Site.

Lee Poe: My name is Lee Poe, William Lee Poe, Jr., and I worked at the Savannah River Site for many years in the Works Technical Department, which is the Plant Assistance Department.

MS: When did you begin at the Plant?

LP: Well, I had to go back and research it because I couldn't remember exactly. When I began at the Plant was October 1, 1953. That day is clear in my mind; but I had worked before at Dana. Talking about heavy water, that was the other heavy water plant, and I think that I worked at Dana from June of '53 through September of '53. I went there for a start-up program process.

MS: Okay. Let me back track a little bit. What was your affiliation with Dana?

LP: It was the same as it was here. I was, actually before I went to Dana I was in Oak Ridge training to come to Savannah River Site in Separations. Because of the start-up needs, they transferred me up to Dana to help get those heavy water units started up, and then came down here to start up these heavy water units. I did- when I first got here, they were in the process of constructing and starting up the units. Looking in Bill Bebbington's report, "The History of DuPont at Savannah River Plant," and what I see is that Dana started up on August 8, 1952, and the first unit at SRP was complete and began start up at October of 1952 with all of it being completed in May of 1953. So I was here during that start up period, and also performed some of the construction checking responsibilities.

MS: How long were you down in the 400 Area?

LP: I was in the 400 Area about two years, but then I went to Separations when they were beginning to start up F Area.

MS: What about, sort of, going forward in time a little bit. When did 400 Area pretty much close down?

LP: I don't remember. Let's see. The Bebbington book ought to tell me. Why don't we go ahead with the interview and then

MS: I think it went sort of piece meal [closing down 400 Area].

LP: Yes, it did

MS: I heard you talking about the Dana Plant and everything. Just for the record, when did you start working for Dana? Did you have any?

LP: I believe I started working at Dana in August 8, 1952.

MS: Okay. How long had Dana been going on?

LP: It was still in its start-up stages.

MS: I heard something

LP: So we operated it for a while before I left to come down to Savannah River.

- MS: Right. What about, I heard something this morning, in fact, from Mitch Burgess that the pilot plant at Dana didn't work out and that they had some problem with it and they went ahead and did construction of Dana and the heavy water facilities at 400 area without benefit of pilot plant and it worked out okay.
- LP: That's correct. I don't remember the details of what was wrong with the pilot plant, but we started up the production units and they worked fine once we learned how to work those big units.
- MS: Right.
- LP: Not overload those trays, the bubble-capped trays.
- MS: What exactly was the process that was used to make heavy water at either Dana or Savannah River Site?
- LP: Both of them were the same. They used the GS Process and Distillation and then Electrolysis. The three units step function is a concentration of the Deuterium and the Oxide increased.
- MS: How long had the GS Process been going on? Was that formulated just for Dana and for Savannah River Site?
- LP: It was formulated, but not for Dana or Savannah River Site. But I don't believe anybody else had ever used it. It was Girdler-Spevack, that's my recollection of what GS stands for, the Girdler-Spevack Process.¹
- MS: If you wouldn't just for my benefit and also just to put it on the tape, what are the basic steps in the GS Process?
- LP: It's a hydrogen sulfide process and what you are doing is the deuterium extracts into hydrogen sulfide, depending on the temperature. So what they did, they rendered a cold system through a series of cold towers and extracted it into the hydrogen sulfide and then re-extracted it in the Hot Towers. I believe I've got that correct. It may not be, but you might want to look it, the details and see, I haven't thought about that for a while.
- MS: Okay.
- LP: And they ran up to about 87% deuterium oxide in the heavy water and then it went over to the distillation process where they carried it on up to, I think it was, 92 or 93 percent or something like that. Then they put it in electrolysis to finish it off, and make specifications. The specifications were pretty high and I better hold up on what the concentration was because I don't know if it was classified or not.
- MS: Yeah. We won't go there; there's no telling.
- LP: It's not terribly important. The thing that was important was that you had to use all three processes. The GS Process was large bubble-cap trays and columns. The columns were 10 feet in diameter and they were heated of course to get the H₂S at the right temperature. It was really a distillation process in that you were using trays inside these columns that had bubble caps on them and there were a number of trays— I don't have any idea the number. But I do remember crawling up inside the towers and crawling up through two or three trays to check on some of the bubble caps at one time. You know, hydrogen sulfide is very toxic; so you have to be sure that the concentration of hydrogen sulfide is low enough that it's not a problem to health when you do those kinds of things. In the 400 Area when we were working the GS we always carried a Scott Air Pac incase there was a release. I never had to use it, I don't think, but it was just part of the safety system we had.
- MS: Was that the biggest safety issue, was the gas?

¹ While Jerome Spevack had a great deal to do with the GS process, it is more customary to call it the "Girdler sulfide" process.

- LP: Yeah. I think that was the largest safety issue. Of course, anytime you are doing large, high temperature, insulated towers you've got thermal problems. But I would think that the gas problem was more acute.
- MS: Right. What exactly is a "bubble cap?"
- LP: A "bubble cap" is a—well, what you do is that you perforate a tray and then put, like, a mushroom on it and it comes up through there and bubbles out through the gas, through the slots in the riser. There is water that stands on top of it and it bubbles through that. Now, of course, the massive size of this was a thing that kept us all busy. We had to keep the towers and the blowers working so that if one went down, you had to shut the whole process down; and then you had to do that very carefully. So, you had to run the whole thing. The major difference between the Savannah River Plant and the Dana Plant was how these towers were configured. At Savannah River they were, I think there were eight units, independent units that you could operate. At Dana it was all one. You operated the whole system or none.
- MS: So there were eight operating units at Savannah River Site and
- LP: Yeah. They were all build together; they were right side by side.
- MS: Right. Yeah. So there were eight separate units that if one went down seven were still in operation.
- LP: You could keep seven running. Now you are pumping both water and hydrogen sulfide and so you've got to continue to make those things work. Since the hydrogen sulfide was toxic, you couldn't allow it to leak out. You had to work the system so that the seals in the pumps and blowers had an independent cavity that you fed water into so that the water would leak out rather than having the hydrogen sulfide leak out.
- MS: Oh. Okay. That's something that would take the hydrogen sulfide out of the water?
- LP: Yeah. Well, no it was just plain; it was just new water.
- MS: Oh. Okay.
- LP: Treated river water, if I remember correctly.
- MS: Okay. I should know this and I don't, but, why exactly do you need hydrogen sulfide in the whole process?
- LP: Well, you're trying to extract the deuterium, which it's natural abundance in water is about 0.01 percent, and you're trying to make it into 99+ percent deuterium oxide. It was used in the reactors to cut down on the neutron capture by the water that would have occurred if you'd used light water.
- MS: So that would have been simply a matter of you capturing the deuterium- the isotopes....
- LP: Yeah. We extracted the deuterium from the natural water and concentrated it, until it was essentially pure, heavy water. And that, of course, was used in the SRS reactors.
- MS: Right. Now before the GS Process and using hydrogen sulfide, how did they get heavy water? Was it solely by some kind of osmosis thing?
- LP: No. I don't think they ever used osmosis. I don't know that they did. There was a little bit of it available. You could get a little bit of it through research. How they got it I'm not sure. We made it by 55 gallon drums-full.
- MS: Oh. Okay. I was just wondering, how did they make it in that place in Norway during World War II?
- LP: Yeah.
- MS: I think they produced heavy water as a by product of what they were making there, but I can't remember how they did it.

- LP: Well, we looked at a whole bunch of different options for making heavy water while I was there and, you know, you can get it from power plant, distillation, processes and that sort of thing. But the most efficient was the GS process.
- MS: Yeah.
- LP: Once you got it out and up to a reasonable concentration, the deuterium oxide boils at a little different temperature than the protium, which is hydrogen- protium oxide. They boil it a little so you can use this distillation process to separate them, but it takes a lot of equipment and a long time to get any real concentration.
- MS: Okay. We've already talked about when the 400 Area was built and everything. Did Savannah River Site get all of its heavy water from the 400 Area?
- LP: And Dana.
- MS: And Dana. Okay. That was it, then. Those were the two sources for heavy water?
- LP: Yes. They were the major sources in the world.
- MS: How did all this, or, was there any major interaction between the heavy water production at Savannah River Site and Dana; and what was going on in Canada?
- LP: We had a representative, Peter Gray, who was in Canada, but I don't think- there was never, while I remember, any close contact between us and them. They were allies of the United States, so we could go and learn by their mistakes and visa versa.
- MS: Right. Just out of curiosity, when did Canada start making heavy water?
- LP: I don't know. I'm sorry. It was about the same time; maybe a year earlier; but, their production plant was very small compared [to ours] and wouldn't have accomplished what was needed by the Savannah River reactors.
- MS: Out of curiosity, if they- correct me if I'm wrong, but they closed the 400 Area long before they closed the reactors.
- LP: Yes. They had stock piled enough heavy water that they could live off the stock pile.
- MS: Okay. I was wondering about that.
- LP: You try not to dilute heavy water because it cost too much to re-concentrate it. But we did maintain the distillation process and the electrolysis process at SRS long after the GS process was shut down; and that was so that we could concentrate some of those waters that might have been diluted.
- MS: Right. So you could make small corrections to the
- LP: Yes.
- MS: Now that makes sense.
- LP: Now that wasn't during my time there, so I really don't know what they did; I don't have any experience on that sort of stuff.
- MS: Oh, okay. Right. What about, how many people worked in the 400 Area when you were there?
- LP: I don't know, sorry. Hundreds, thousands probably but I don't know that.
- MS: Out of the eight units, were the people that worked down there interchangeable or did they always go to the same unit?
- LP: No. They were interchangeable and one operating group operated several units. So there wasn't one operating group for each unit. It was several had one and several had another. The point that I played

was providing technical support to the manufacturing plant. So if they got into any problems we were supposed to help them get out of them.

MS: How many people worked with you in that side of the operation?

LP: Well I can recall an organization of about 50, but I don't know any closer than that; I'm sorry Mark.

MS: Yeah. Well that's fine. I know we talked about this already to some degree but in addition to the gas and everything, what were the main safety concerns in the 400 Area; or was the gas the main thing?

LP: The gas was the main thing. Well, I say that; always if you've got high temperatures you worry about burning someone or scalding people. It's such a big system, that you have to really be careful that when you shut down that everybody knows it and is out of the way so you can get ready to start up again. So you have to know where everybody is at that time; otherwise, you'll start it up with a person working on a unit and scald him to death. But that's small compared to the toxic issue. Then of course, in the electrolysis part of the process you could electrocute a person; you know, it was electrically operated cells that were doing the separation.

MS: I guess the 400 Area has its own powerhouse.

LP: There was a powerhouse built for the 400 Area and it's still down there and there's still, right now SCE&G is operating it, as I understand it, for DOE.

MS: Oh, really? I haven't been down to 400 Area. I don't think I've ever been down to 400 Area, so I'm not quite sure.

LP: Well, it's a stone's throw from the old town of Ellenton. When I first went to work there, we actually were housed in the school building in Ellenton because there were no office facilities for us at that time. They later built a building- that after a while we moved into the building that was the Tech Support Building.

MS: Did you all ever eat at that Cassels store [in Ellenton]?

LP: Oh, yeah. We'd go over and buy stuff there. They had a continual- they had a sale that went on for years; a going-out-of-business sale. But the system wasn't like it is today, where you go off and spend an hour eating lunch. You had a certain period of time you had to be back and you actually didn't have the freedom and flexibility to go out of the area to eat. We ate at night there sometimes.

MS: How many shifts did they have at the 400 Area?

LP: Well the production unit was on four shifts; operated a four-shift operation, 24 hours a day, seven days a week, and we were on days. Now, Dana had another problem. It's cold up there and you had to keep the steam traps working. So they had a big crew of people that went by with a big stick and just kept the steam traps [clean]- beat them, you know, to keep them operating. Because if they froze up, the unit would shut down, and steam traps had a notoriously high failure frequency.

MS: Yeah. I think they mentioned that.

LP: And at minus-10 [degrees]- for a southern boy, that's pretty cold.

MS: Right. Yeah. That's true. That'd be pretty bad. Talking about being that close to Ellenton, did the workers in the 400Area have a special relationship with the people who were working at CMX/TNX, because you were so close by?

LP: Very little contact between CMX/TNX and the 400 Area. We supplied their power from the 400 Area power plant, and [their] steam. But we were in a different part. You didn't go outside [your area] at that time in the early '50's. You did your part and that's it.

- MS: You didn't go anywhere else.
- LP: You didn't go anywhere else. In fact, you didn't even know when the reactors were starting up. It was just, the total system was silent. You'd go home and you didn't even talk about it.
- MS: I'd always heard that and find it somewhat hard to believe, but I think it was probably true.
- LP: The environment was different then than it is now.
- MS: Right.
- LP: We were doing a war effort.
- MS: Yeah. That's true. Talking about that, what was security like in the 400 Area?
- LP: Well, you came into the area and you had to go through security to get into the area. You had to wear badges, but I never was called on it, after you got inside the area. I know there was security because we saw them walking around. They were just being sure everything was safe, was secure, I guess, not safe, but secure. You had to have your clearance in order to get into the 400 Area.
- MS: How difficult was it to get clearance back in those days?
- LP: Well, they investigated everybody that came in with a Q clearance; and I guess they investigated everybody with an L clearance. There were a lot of them, so, there was a lot of clearances being granted. It took about four months to get the clearance.
- MS: What a typical day like in the 400 Area?
- LP: Everybody went to work in carpools. Your carpool came by and picked you up and you rode out and then you left and went to work. You worked the morning and then you had lunch and then you'd work the afternoon and then you met your carpool on time to go back so you didn't inconvenience everybody else. Everybody kept to the schedule, so the carpools were a great opportunity. That meant you didn't have to take your wife's car, your car away from your wife. She had the car most of the week, all but one day, when you were driving, when you drove the carpool. We rotated drivers in the carpool.
- MS: I heard that some people that didn't want to drive in the carpool; they might contribute money to get out of driving their day, or something.
- LP: I guess that's right. I heard that same thing. Most of us drove one day a week.
- MS: I think you already mentioned this, but most people ate lunch right there in the area? Did you have your own cafeteria?
- LP: There was a cafeteria in the same building that was the Tech Support building that our offices were in.
- MS: Roughly, how many buildings were down there in the 400 Area?
- LP: Oh, I don't know. I would guess, counting the production areas, there was the GS Area, the DW Area. Each of them had a control room. Then there was the E Plant and it had a control room; and there was the Support building and there was a 704-D, which was where all the management stayed. An analytical laboratory was in the Tech Support building also, lunch room, all the services like that.
- MS: What was the E Plant?
- LP: Electrolysis. The tail end that topped it off; that made it right- the right concentration.
- MS: Okay. As far as working in the 400 Area, what made that different from working in any other area of the Savannah River Site?
- LP: The H₂S- and the need to- it smelled like rotten eggs all the time. The low concentration of H₂S is- the first designation is it's the rotten egg, and then when the concentration gets too high you lose your sensory

perception; you loose contact, so that's dangerous when that happens. Then somewhere above that, you pass out and die if you aren't picked up pretty quickly.

MS: Yeah. What was the, I think I heard something about if there was up to 2 percent you could smell it and if it's higher than 2 percent....?

LP: Something like that; I don't remember the numbers but that's probably somewhat right.

MS: But, you're right; if you don't smell anything you're in danger.

LP: Yeah.

MS: So, in other words in theory, that place would smell rotten eggs all the time.

LP: That's right.

MS: That's pretty rough.

LP: It smells like, well, a lot of plants; a lot of the petroleum plants do that for the same reason. You smell the H₂S.

MS: Yeah. Right.

LP: We just had the highest concentration of H₂S of anywhere in the country.

MS: How did people take care of that stuff? It must have been

LP: You don't leak it out; you don't release it, you keep it contained, and then it's okay.

MS: What was it contained in?

LP: Pipes. Tanks.

MS: Regular stainless steel stuff?

LP: No, not very much stainless steel. Most of it was steel because there wasn't much stainless steel around that wasn't being used by 200 Area or 100 Area.

MS: Right.

LP: 400 Area was mostly carbon steel stuff.

MS: Yeah. So that would have been, 400 Area would have been one of the very first areas that started up then?

LP: Well, it had to start up first.

MS: Exactly, provide enough of heavy water for the reactors.

LP: The CMX/TNX were up and running at about the same time, in the same timeframe. They were doing research and support for the 100 areas, and the 200 Areas. CMX was 100 area, and TNX was 200 area- Tech support.

MS: CMX was doing the initial research was on river water.

LP: That's right, would it plug up everything?

MS: Right. Exactly. As I understand it, that's one of the reasons why the Dana Plant pilot plant didn't work was that it got the little membranes in it or something got plugged up, or whatever. It didn't work.

LP: I read the article in Bebbington's book and I couldn't find anything on Dana. We were talking about that; but, there was a problem. I don't remember what the problem was. You're probably correct.

MS: That I got from Mitch Burgess just this morning.

LP: He probably knows more than I do about that.

MS: Yeah. That was kind of interesting.

- LP: In fact, I don't even remember the pilot plant and I was up in Dana for about five months. I hadn't thought about it when you mentioned it earlier in the interview.
- MS: Well I could be wrong, but I don't think Mitch had any personal experience with the pilot plant. That's just stuff he heard and I think it was even before his time, when he was there. Why did they set up a facility in Dana anyway? Why was Dana set up where it was?
- LP: Dana was a war facility that had been built for another purpose and they took it on and converted it into a heavy water plant, because they could get it up quicker. You know back in that time, you were racing against the clock and you had to use whatever facilities around the country that you could.
- MS: Right. How much, let's say when Savannah River Site was up and running and 400 Area was up and running, how much heavy water could they produce in, let's say, a day?
- LP: I don't remember; not much, well you know in terms of pounds.
- MS: Right. In terms of, let's say, 55 gallon drums; how many would have gone out of there in a week, let's say?
- LP: I don't know.
- MS: I wouldn't think that they'd classify it or anything by now.
- LP: I don't know.
- MS: Yeah. I never heard a figure on it.
- LP: We saw them load, and I would have guessed that you put out one or two a week, but that may or may not be wrong, because I never really worked in that part of it.
- MS: Right. Well that's one of those things too. They probably didn't spread that around.
- LP: That's right; you didn't want your enemy to know what you were doing.
- MS: Right. Well, that covers all the questions that I've got to ask, but I know that there's a lot more that you know, that I don't know enough to ask about. If there's anything that you want to add, please feel free to do so, because we've got plenty of tape.
- LP: Well, I think that you have to realize that we were young people at the time and working there, and the one thing that I remember was there were very few, or no, air conditioned offices or anything like that. I remember when I first went there and working in the 400 Area, I'd come from Alabama so I know about gnats. But the gnats were about to drive the people from the North crazy because they were just all over you, and you could swat them away or shoo them off. There were a lot of bugs and other things down in that part that you had to put up with.
- MS: I'm sure; that's close to the Savannah River.
- LP: In the 400 Area, in the control room, on the evening shifts, we'd try to get out management to get us some insecticide so that we could spray the mosquitoes and get rid of them and the roaches and all that kind of stuff. But that wasn't very high on their list of priorities, so what we did was one night we killed them all and piled them up on the table on the desk in the control room so when the day shift came on they could see them. Boy, we caught the mischief over that. They didn't think that was necessary. It wasn't; we were just proving a point. Pretty soon after that we got DDT insecticide; anyway to make life a little more palatable.
- MS: Yeah.

- LP: I guess the other thing that stands out in my mind is there was an awful lot of safety for gas problems. Like I said, you were carrying a tank on your back, like a scuba tank, full of air so that you had a chance to get from wherever you were, if you were hurt, or if there was a leak out.
- MS: Was that the Scott Pak that you mentioned earlier?
- LP: Scott Air Pak. You had to put that on and there were a lot of emergency drills to get that on quickly and make sure it was working correctly. So there was a technique that we were using for that. It seemed to work quite well and as far as I can remember, nobody was ever killed from the gas. There were several people that were overcome and somebody had to help them— their buddy. We always worked as a buddy, a pair of us, so there was always somebody to pull you back if you needed to. Like I mentioned earlier, we had to inspect some of the towers internally because we found that if you put too much water on the tower it would crash down to the one below it and you had to go fix them and put them back up so that they— they were lighter gauge material and you could put enough head on them that you could knock them down. And so, we had to go in and inspect corrosion of those bubble caps and change out some of them. So, you know, you were in crawling through the bubble caps. It wasn't a very clean activity.
- MS: Yeah. Right.
- LP: The other thing was, there was, in case of emergency, you can flare your tower; open up a valve and the gas would go about a 400 foot flare, a 400 foot tower, and burn at the top. We had to, occasionally, go up and check the igniter on the top of that tower. I remember that was really an interesting; some of us could do it, most could not climb that far up.
- MS: How many feet was that again?
- LP: 400 feet; 400 foot high tower.
- MS: That's a long one, yeah.
- LP: Then there was a caged ladder, you know, going up so if you were in a cage, but you didn't want to fall either. So, we'd go up and check that igniter and replace it. But there were a number of events that had to take place in an operation like that to make the thing work. Nothing works the way you'd hoped it would work. There's always something that you learn, that you learn how to get around the problems.
- MS: Right. Right.
- LP: Mark, that's about what I know of to tell you. We didn't talk much about the DW Plant or the Electrolysis Plant.
- MS: Okay. Please.
- LP: I got a couple of things there
- LP: The Electrolysis Plant, what you do is if you have a cell and you're running electricity through, and you're making hydrogen and oxygen. So there's always an explosion potential in a cell itself. Now these are small, but not tiny, what you are talking about. So you had to be sure that the gas system, vent system, works correctly.
- MS: Right. The other one was the?
- LP: DW Plant was where you took the heavy water and fed it into the plant through distillation process; concentrated the deuterium. And it was a commercial
- MS: That was done through distillation right?

- LP: It was a commercial plant. Why I think they located Dana where they did, was because that Plant was already there. Down here, I think we built it. Built the one to do it.
- MS: Okay.
- LP: I said security was tight and it was. A lot of times the people in the GS Plant didn't know what the DW Plant was doing and visa versa. There just wasn't any need to talk about that. If there was no need, then it wasn't discussed.
- MS: Right. Yeah.
- LP: Your job depended on it.
- MS: Right. The GS Plant pretty much just got you the basic
- LP: Yeah. It carried it from 0.01 percent deuterium up to, I think it was 80 percent deuterium, 82 percent, or something like that.
- MS: Well that must have taken a lot of river water to
- LP: Well there was a lot of river water pumped out of the river for that. Not like the 100 areas.
- MS: Yeah. Right.
- LP: But still, it was a lot of water.
- MS: Right. Okay. I can't think of anything else that I need to ask, but is there anything else you want to add that I probably haven't been able to cover or haven't thought of?
- LP: I don't think I do.
- MS: I know we were going to go back to talk about when the 400 Area got phased out and you were probably, you said you were gone by then.
- LP: I was in the 200 Area by then, but it phased out, and all of a sudden we sold the towers to somebody for scrap. They came in and moved them out; but I didn't have any part of that.
- MS: You must have had a lot of, a big supply out there.
- LP: They had a lot of pipes.
- MS: They must have had a lot of heavy water; I take it they didn't need to process anymore.
- LP: Yeah. Actually they got to the point where they were selling some of it.
- MS: Out of the country or just
- LP: No. I think in the country. I think research mostly.
- MS: Okay.
- LP: You know, if people wanted to do research on the heavy water and so they would buy it. You know, heavy water looks just like light water.
- MS: Yeah. I think it was over at, I can't think of who I was interviewing. This was years ago. I think there were going to be initial interviews and stuff like that. I think Steve Gaither, I think, interviewed you. I ran across your tapes from 1999 and I interviewed [Mel Sires], who was with DOE- before that of course the Atomic Energy Commission- and he had a little vial of heavy water and it was just like regular water. I think he said something that if you
- LP: It had different properties.
- MS: It had different properties, but if you had to drink heavy water constantly in order to live that it would probably kill you. That's because there are certain membranes or something that
- LP: Well, (inaudible).

MS: Yeah. I've forgotten now, what the deal was with that.

LP: Boy, you'd have to be rich to.....

MS: Yeah. You'd have to be rich to even try

LP: To try ...

MS: Yes, that's true, that's true. If you can't think of anything else I can go ahead and turn the machine off.

LP: Okay.

END TAPE

NEW SOUTH ASSOCIATES – INTERVIEW WITH
RICHARD SHULKO

Interviewee: Richard Shulko

Interviewer: Mark Swanson, New South Associates

Date of Interview: November 16, 2006

Mark Swanson: Today is November 16, 2006 and this is an interview with Mr. Richard Shulko. If you would, just for the record, state your name and your affiliation with the Savannah River Site.

Richard Shulko: I'm Richard Shulko and I've worked at Savannah River Site from 1953 to 1997. I worked in the 400 Area for four years, from 1953 to 1957.

MS: That was in the 400 Area?

RS: Yes.

MS: Did you have any experience at the Dana Plant

RS: No, I never did.

MS: Where did you come from when you came?....

RS: Right from school from Clarkston University, now the University of, it was a college when I went there, in New York State.

MS: Okay. If you would just for the record, state when you were born and where.

RS: I was born in 1930 in Binghamton, New York

MS: Once again, just for the record, when did you start working for the Plant again?

RS: 1953

MS: 1953. You worked in the 400 Area until 1957 right?

RS: Yes.

MS: Just for the record, what other areas of the Savannah River Site did you work in?

RS: Oh many; mainly in Separations, F and H Area, Waste Management, in the glass encapsulation project [DWPF] and then in Budgets for several years. I think that's about it.

MS: Okay. So that's waste

RS: Encapsulation, yes.

MS: So you didn't work at the Dana Plant?

RS: Never. No. I think it was closing down in about '53 or '54.

MS: Yeah. I think it did. It was going a little bit before Savannah River Site, and then after they really got 400 Area going.

RS: Right. I think in '52 I might have been (talking over each other, inaudible)

MS: What was the basic connection between Dana and the 400 Area, or was there one, aside the fact that they had the same type of facilities?

RS: That was about it. It was, I'm not sure. I guess DuPont had leased it [Dana]. I'm not sure. And then they started to make heavy water previously. Although I don't know if they- the capacity, they needed more capacity. As I said, it wasn't completed in '53; they were still constructing SRP so I guess they [Dana] produced heavy water before we got started.

- MS: Okay. If you wouldn't mind just for the record, just describe briefly what the GS process was?
- RS: Well it was concentrating deuterium oxide from normal Savannah River water to reactor-grade material [heavy water] which was about 99 percent plus pure, and it used hydrogen sulfide as the carrier. I didn't work in the GS Process; mainly I was in the finishing of the electrolytic plant.
- MS: Yeah, I heard that there were three different plants, that the GS Process was the first part.
- RS: Yeah, which brought it up to I guess about 20 or 30 percent.
- MS: And then you had a distillation
- RS: Right. I worked in there for a short while, but mainly in the finishing
- MS: The electrolysis part?
- RS: Yes.
- MS: I heard about the three different plants, but I'm not really- because I've never seen any of the 400 Area facilities, they are all gone now. I'm just trying to get an idea of what they were like.
- RS: The towers, the hydrogen sulfide process was in towers and there were three buildings, and then they shipped the material to the distillation, and then when, I forgot exactly what percentage it got up to with distillation, probably about 85 or 90, and then....
- MS: Electrolysis took it up to close to 100 percent, right?
- RS: Yeah.
- MS: The big towers- that was the GS Process?
- RS: Right.
- MS: The other two facilities or plants, what was their main characteristic?
- RS: Well, the distillation was similar- small towers- and then the electrolytic, that was the building with the electrolysis. You didn't want to go in there with a watch.
- MS: Right. Roughly, when was the 400 Area built?
- RS: It started, I think, in '51. It was still under construction when I arrived there in '53, so mostly it was built in '52.
- MS: Okay. When was it phased out?
- RS: Oh, boy!
- MS: Or however many years
- RS: Years, yeah. I don't know that. I don't remember. I used to know that.
- MS: Most people I've talked to couldn't give you a specific date because I guess it was such a general thing.
- RS: We produced a lot of heavy water and it went into storage and then it cranked down and people were worried about the corrosion aspects of the hydrogen sulfide in those.
- MS: Okay. Is that why they made so much of it and just stored it and then tore everything down?
- RS: Yeah.
- MS: Because the reactors went on for a lot longer after they stopped making heavy water.
- RS: Right.
- MS: After the 400 Area was closed down, how did they process heavy water? Didn't they have any contamination problems in the reactors?
- RS: Yeah. They had small units where they cleaned up [the heavy water]; I don't recall how they did it. I think by evaporation or distillation.

MS: Were these facilities at the reactors?
RS: I think so.
MS: How many people worked in the 400 Area?
RS: Oh, golly. Oh, I think it was probably about 1,000, I think.
MS: It was a lot. It numbered in the hundreds.
RS: Yeah. We were operating three shifts, seven days a week.
MS: What was the main safety concern in the 400 Area? Was it the gas?
RS: Yes. Everybody had canisters and little indicators, particularly if you went out to the units. And your nose was the first indication, because it smells like rotten eggs.
MS: I heard that
RS: Now if you smelled that, and then you didn't smell it, you were not sure you were safe because it paralyzes it [the olfactory sense] and you could be in real deep trouble.
MS: Yeah. I heard about that. I hadn't heard that before until I started these interviews; they said that if everything was going well you wouldn't smell anything, but if you smelled the rotten eggs, you had a problem. And then after you smelled it, if you didn't smell it anymore, the concentration got too high, and you'd better get out of there.
RS: DuPont, I would have to say, is one of the safest in the industry, in both chemical and nuclear safety. We had the buddy system, where if you went out in the units, you went in pairs, and you had an emergency- I think it was 10 minutes- air bottle with you. So if you
MS: Was that the Scott Pack?
RS: Yes.
MS: What exactly was that Scott Pack?
RS: It was compressed air.
MS: Was it like a little tank or something?
RS: Yeah. Like a scuba diver.
MS: Like you carry it on your back?
RS: Or on your side.
MS: How much did that weigh?
RS: Oh, it wasn't very heavy; I guess about 10 lbs.
MS: Did people have to use them frequently?
RS: Not frequently. That was the main concern, with any leaks or anything.
MS: What was the security like in the 400 Area? Was it as tight as it was in the reactors?
RS: Yeah. Probably. You know it's all the way down by the river and you had to go through the main gate. From Augusta it was probably about 15 or 20 miles before you reach the site, and then there was a security gate at the facility.
MS: With all the people working in the 400 Area, did you often get together with people at CMX/TNX?
RS: Yes. I worked, in fact, my first job was at TNX for three months and then I was transferred to 400 Area.
MS: Okay. Right.
RS: We went to lunch there, if you didn't bring your lunch- most everybody brought it because it was inconvenient to get a car.

- MS: Did you go up to eat at that Cassels' place in Ellenton, or was that already gone...?
- RS: No. That was gone by the time I got there.
- MS: Did they have a cafeteria in the 400 Area?
- RS: Yes. It was pretty large.
- MS: Okay.
- RS: And that was where my office was, in the cafeteria building; and it also had laboratory in one building.
- MS: Did you work in the Lab?
- RS: No, not really. I was in Technical Support. I had a lot of interface with them [lab], but they wouldn't let me get into the chemicals, although I was a chemical engineer.
- MS: Okay. What was your typical day like in the 400 Area?
- RS: Well, first thing, you'd go read the overnight logs to see if they had any problems. Then if they had some, that was your first concern, try to solve what was going on.
- MS: These would have been logs about the heavy water production.
- RS: Yes. Or anything, whether electrical was stable, or something was happening.
- MS: Right. Talking about that, who was it? Don Duarte, I talked to him yesterday, and he said—or maybe it was Lee Poe. They were saying if at all possible, to interview somebody who worked at the powerhouse down in the 400 Area because they had a lot of powerhouse problems.
- RS: Yeah. And that would be— you'd have meetings, you know, to try and solve the problems. They were coal (old?) power people, and they knew they knew exactly how to run things and we were the new people off-plant, or out of school, who...
- MS: What were the nature of the powerhouse problems there?
- RS: Oh, well, this was maybe in the GS, trying to keep the steam pressure up and the production up.
- MS: Okay.
- RS: And then, you know, you have the problem with coal, if it rained— I think the berm was outside and it [coal] would clump up and then we'd have some problems.
- MS: Yeah. You were talking about your typical day at the 400 Area.
- RS: Well, like I said, if someone had a problem, if they had to go and read some things in the columns, I would act as their buddy quite often, and also learn, you know, where to go there as well. A funny thing, I had a little bit of vertigo, and going up the columns were a couple of hundred feet high. The walkways, some of them were concrete and I didn't have any problems there; but it was the ones that had the grating, that you could look down straight through. And actually, they were safer than the concrete, because they tended to corrode and some of them fell. But no one was ever hurt. When they had the first one [fall], they started to have extensive inspections.
- MS: Yeah. I heard about checking the towers and going up a couple hundred feet....
- RS: Sometimes you have to take readings up there, and I don't think anybody, I wasn't
- MS: I think I'd just chicken out.
- RS: And then the biggest thing some people— you know we had a big flare tower that was 400 feet.
- MS: That's the one I heard about. Did they have to do readings up there?

- RS: No. There were inspections, I think. It wasn't often. I think once every two years or something. You had to take a special physical because it was a long climb up there. They had a larger thing that they had to haul with them, in case a— a thirty minute thing, which was a lot heavier than...
- MS: Just out of curiosity, when 400 Area was in full production, how much heavy water could they produce in, let's say, a day?
- RS: I don't remember that figure, but it was a lot.
- MS: Nobody has actually been able to give me a figure on that. They said it was such a continuous process, it was hard to cut it off at a day and say that we produced five drums or so.
- RS: They used stainless steel drums for storage, or transport.
- MS: Where were these drums stored?
- RS: Well, I think there was a building in the 400 Area initially and then as the reactors came closer to opening, they were moved over to the reactors.
- MS: Okay. So they were kept the reactor areas?
- RS: Dispersed— mainly in 400 Area.
- MS: Okay. We talked about the CMX/TNX a little bit, but was there a special connection between the two?
- RS: No. Not particularly.
- MS: Was it solely because it was close together?
- RS: Right, and TNX was very small. It did tests for the entire plant, for the reactors and separations.
- MS: Okay. I asked about the heavy water, how much they produced there? Nobody's been able to give me a figure on that.
- RS: It should be in some of the
- MS: Yeah. It's one of those things we can look up.
- RS: I can't remember off the top of my head.
- MS: What about— like in the laboratory they had there in the 400 Area. What did they study? Primarily just the
- RS: Making sure the purity was what they wanted.
- MS: Yeah. 99.9 whatever percent?
- RS: Yeah. Right.
- MS: Were there ever any other kinds of testing that was done down there, or was everything there?
- RS: It was a pretty big lab, but I don't think so. I think it was mainly the purity of the water coming in, and the algae problem. There might have been something for the reactors, but mainly for the 400 Area.
- MS: I'm trying to think if there is anything else in particular that would be good to cover, but I hadn't thought to ask about what went on in the 400 Area. How many buildings, all totaled, would there have been there back in the '50's?
- RS: Well, there was an Administration, which was 704, the Laboratory, the Office Building was another large one. There were three operating columns—trains— and they had their own control rooms associated with them. And then distillation had their own control room and they....
- MS: Was distillation just one [building]?
- RS: No. It was several columns, I forgot how many now; I think it was about five.
- MS: The things they reported that you could see from the railroad, as it was going through, or the highway?

- RS: Well, you could probably see the columns
- MS: Those were the GS towers.
- RS: Yes. The distillations were a lot smaller.
- MS: Okay.
- RS: And the flare tower, you could probably see that pretty clearly.
- MS: What exactly was the flare tower burning off? Was it H₂S?
- RS: Yes. It was for an emergency. If you had a great leak, you had to flare it, you know? Burn it immediately. Because it [hydrogen sulfide] was heavier than air so it tended to go to the ground level.
- MS: How many incidents of leaks of hydrogen Sulfide did you have?
- RS: I can't recall of any major ones.
- MS: So they didn't have any major incident reports, like you have in the reactors?
- RS: No. Where you had to evacuate, no
- MS: Right. Write it up
- RS: You'd have pumps and things and gaskets- set you up- and then when we had a general maintenance, you had to evacuate all the H₂S, put it in the flare or put some back in storage.
- MS: Yeah. That covers all the questions I can think to ask; but of course, I have certainly not covered the whole experience in the 400 Area. If there's anything that you can think of that you'd like to add, we have plenty of tape.
- RS: Well, this experience coming out of school where that [working in 400 Area] was the closest experience for a chemical engineer- where reactors it's totally different. Personally, it was a good experience for me because it was things that you studied in school, distillation and H₂S, but fortunately Du Pont- I don't think they had any other processes like that- was very used to working with hazardous materials.
- MS: Let me ask this about H₂S. Why was H₂S even used, for example? Why was it even used in the GS process?
- RS: It was- and my memory starts to fail
- MS: Just generally.
- RS: It provided a- it absorbed, I believe, the deuterium preferentially at different temperatures.
- MS: Okay. So it was used really to isolate the deuterium out of all the river water that would come through the system, it would seize on that.
- RS: Then slowly concentrate it up, because, in water- I've forgotten what the percentage is, but it's very small.
- MS: It's like one fraction of one percent.
- RS: Yeah. Something like that.
- MS: What about, I've probably got the word wrong, but they call it a "bubble cap" or something, a bubble top? Like these trays?
- RS: Yes. Trays. That's how they, they had a flow, and there was the mixing
- MS: Right. Somehow this deuterium was captured in these trays and it never really clear to me, though, how deuterium got into those trays. These were inside the columns, right?
- RS: Yes.
- MS: And it just- was it some membrane that would?
- RS: No, not a membrane.

- MS: That would let the rest of the water through, and the deuterium would stay there?....
- RS: It [deuterium] was captured by the gas, and went from there. You had a cold train and a hot train- I've forgotten the- since I didn't work there, I didn't know the—I did have a good understanding when I was there, but I didn't have it as a primary responsibility.
- MS: Going back to a typical day, after you went through all the nightly reports and double-checked that stuff, then...
- RS: Then you'd try to improve the process. One of my last things was try to see if we could expand the usage of the- eliminate the concentration with the evaporation and shut that down as to improve the processes. Such projects like that.
- MS: But basically, the GS process and the other stuff, the distillation and electrolysis, that was all basically understood even before the 400 Area was put in, and it was just a matter of improving it and making sure the production
- RS: Yeah. Yeah.
- MS: Just for my information, where does the GS process all worked out?
- RS: I guess it was probably at the DuPont in Wilmington. And then they tried it at
- MS: Dana Plant?
- RS: Yeah. Dana Plant, and that was a much smaller plant than 400 Area.
- MS: I just assumed- they certainly knew about heavy water, they had some heavy water during World War II, but I wasn't sure how they made it
- RS: Electrolysis.
- MS: ...at that Norwegian plant?
- RS: Yeah. That was electrolysis.
- MS: That pretty much covers all the questions that I have to ask; but if there's anything else that you want to throw out?
- RS: No. I can't think of anything. It was sorry to see it go, since it was the first place I worked at.
- MS: Yeah. To be honest with you I haven't been down to the 400 Area.
- RS: From the pictures I've seen, we had the 25-year thing, they showed the pictures....
- MS: I think it's just pads, that's all that's left there.
- RS: Yeah.
- MS: That's all that's left of CMX/TNX now; if you go down there now, it's just pads. All the rest of it is gone. It's kind of too bad.
- RS: Oh, and we didn't have any air conditioning. The only things that were air conditioned were the control rooms because the instruments
- MS: ...Couldn't handle it.
- RS: Right. And the laboratory. But the offices had either fans or had that little circular fan, and your papers would blow away.
- MS: When did they put air conditioning in, as a general thing?
- RS: Probably about five years after the main construction.
- MS: I talked to Paul Dahlen, who was in charge of CMX and he said the same thing. The first year, in particular, there was no air conditioning. He said the first summer they were there and they had to work

up all this paperwork, all these procedures, and the papers would stick to you; it was hotter than all get-out, especially since he was from Minnesota or somewhere.

RS: So was I, New York. I was about ready to give it up after the first year, but then the second year got easier.

MS: They maybe some air conditioning came in. That's probably true. I think that was true across the board at Savannah River Site, except maybe in the control rooms, the reactors. All the other buildings probably were not air-conditioned.

RS: It was not initially. Well, I think they thought maybe you'd get a little more production out of the force if we could make them a little more comfortable.

MS: Exactly. I can't think of anything else. If there anything else you can think that you might want to add?

RS: I was trying, you know when you called, to remember a particular anecdote, but nothing came to mind, except for the tower- the slabs were more dangerous than the [grates]

MS: Right. I can't think of anything else. I guess, of course, the 400 Area had to be right by the river because they were pulling so much water.

RS: Yes.

MS: What kind of pumps did they use the in the 400 Area to do this kind of work?

RS: I guess I never saw them, but they must have been tremendous.

MS: I heard that for the reactors, they used what they call Bingham Pumps?

RS: Yeah.

MS: I not sure they were the initial pumps, but....

RS: I think they were the main producer of large pumps, I'm sure we had them too.

MS: Yeah. You probably had to, because of the huge amount of water that had to go through, just like the reactors had to have, but for a different reason. Okay, well, thank you very much, and if that's it, I'll turn this thing off.

END TAPE

NEW SOUTH ASSOCIATES - INTERVIEW WITH
ELSIE WOOD SMITH

Interviewee: Elsie Wood Smith

Interviewer: Mary Beth Reed

Date of Interview: November 4, 2006

Mary Beth Reed: I have the privilege to be interviewing Ms. Smith, right?

Elsie W. Smith: Elsie Wood Smith.

MBR: Okay. Elsie, what was your association with Savannah River Site?

EWS: I came to work out there right out of high school when I was 18 years old, in 1953.

MBR: In 1953?

EWS: And my first job was in 400 Area. I worked in 400 Area for a year, and then I transferred to F Area, and I worked in 773-D. This was 1954. And there was still putting [radio?] benches and sinks in, and we had to take our glassware to the restroom to wash it.

MBR: So were you part of the lab?

EWS: Yes, in the lab. And it hadn't hot. We didn't have anything. We was just doing dummy samples, going through the procedures, doing [unintelligible] samples and, you know, getting prepared—

MBR: Getting ready.

EWS: —[for] when the hot samples come through. So we did that for about a year, and then the first hot sample that came through was—Betty Johnson Waters and I analyzed it, and they had[health physics?] [unintelligible], which we called them HP that followed it from the canyon all the way over to the lab, logging it in, bringing it to the lab, and we putting it in the radio bench, and they had three HP guys following it, and it would read 700 mR [milliroentgens]. And she and I analyzed the first hot samples that came through the lab.

MBR: When you say, hot sample of?

EWS: Radiation.

MBR: Of radiation. Oh, my goodness.

EWS: Yes. I'm sorry it was radiation.

MBR: Right.

EWS: We're talking hot. It's radiation. We called them hot samples.

MBR: That's something else, isn't it?

EWS: And I worked there for six years, and I got pregnant, and back then, whenever a woman got pregnant, she couldn't work but three months, and they made them leave after three months. The first three months was the most critical of a pregnancy.

MBR: Sure.

EWS: And I had to work the first three months in radiation, and they didn't have any protection. I didn't have lead-lined aprons that they had later on, and I worked in radiation for three months, and then I left. And then when I wanted to come back, they said, "Well, we're not hiring ladies back in the lab anymore. We're not going to have any more ladies in the lab." And so I had two more babies, and then they

called me back in the lab, and I came back. I was gone six years, and I came back in the lab, and I got the same job back, and when I came through, it was like time had stood still.

MBR: Really?

EWS: The same patrolman was sitting at the gate.

MBR: [Laughs.]

EWS: And I walked in the lab. The same supervisors were sitting in their office. They said, "Hey, Elsie. Hey, Elsie." Walked in the change room—we called them change room because we had to put on coveralls. We had to wear coveralls.

MBR: So you wore coveralls?

EWS: Went into the change room, and there was my foot locker with my shoes still in it.

MBR: [Laughs.]

EWS: Same foot locker. And I kept thinking, You know, I've been gone six years. It was just like nothing has changed.

MBR: [cross-talk; unintelligible].

EWS: Went back to my same old job. And I worked there seventeen years, and then I went to 320, and that's when I worked for Mr. [Joseph?]. I worked for him for two or three months at 320—322. And then I transferred from there to 773, and I worked in 773, and I had a lot of good supervisors there. But I was there about a little over ten years, I think, in 773. And I worked in analytical, and then I went, transferred to waste management, and then I transferred from there to environmental group, in 735, and I worked there the last ten years I was out there, and I retired in '95 with thirty-five years.

MBR: Thirty-five years.

EWS: Yes.

MBR: Oh, my goodness. And you started?

EWS: In 1953. I was gone six years, and then I come back and worked the first six years, and then the last part all added up to thirty-five years.

MBR: Wow.

EWS: If I hadn't had babies, three babies in six years, I'd have had a lot more time.

MBR: Oh, yes. No, no, you're [unintelligible]. All right, well, let me ask: Now, where were you born?

EWS: In Barrow County, Winder, Georgia.

MBR: In Winder. Okay. And how did you—

EWS: Well, when I graduated from high school, and I had an uncle that was working at the Pontiac place in Aiken, and he was here when the building blew up downtime.

MBR: Oh, yes.

EWS: You probably read about that.

MBR: I saw the picture.

EWS: [unintelligible] probably you were born.

MBR: Right.

EWS: And he came back to Winder, and he was telling us about this building that blew up, and he was telling about they was hiring people out at the Savannah River Plant, and they start off paying you real good. And I graduated from high school, and everybody I graduated with—there were sixty in my graduating

class. They was either going to Atlanta and going to work or they was going to college. And my parents couldn't afford to send me to college, and I was going to have to go to work. I didn't want to go to Atlanta, so I said, Well, I'll go there and put my application in. So I came back to town with him one day, and went out there and put an application in. I was 17.

MBR: Now, where did you go to put your application in? Do you remember?

EWS: Yes, the plant.

MBR: You went all the out to the plant?

EWS: Yes.

MBR: All right, okay. Hey!

EWS: And put my application in, and the man that interviewed me said, "Well"—I was [there with the Wood?]"—"Well, Miss Wood, you have to be 18 to go to work here." And so I wouldn't be 18 for about six months—well, not that long, a few months. "Well, you come back when you turn 18." I said, "Okay." And so I went back home, and I was living with my grandmother at the time, and I told her—I said, "I want to go back to [unintelligible]." I said, "That's a long way from here." Back then, that was 140 miles.

MBR: [Laughs.]

EWS: I said, "That's a long way from here. I don't know if I want to go back or not." But they called me and wanted me to come back, so I went back out there, and they said, "Do you want to work"—I said, "I don't want to work in clerical. I don't want to do secretarial work." I took typing in high school and shorthand and all that. I didn't like it. I said, "I don't want clerical." And they said, "Well, we're hiring people in the lab, and they're making a lot more money than clerical." And I said, "Well, that sounds good." I said, "I took chemistry in high school, but I didn't make real good." "That's all right. That's all right. We'll train you."

MBR: [Chuckles.]

EWS: And so then I was staying with my uncle, and I told him—I said, "Well, they want me"—I told him—I said, "Well, I got to go back and give two weeks' notice where I'm working," but I didn't have to. I just told them that because I said, Well, I want to think about it some more.

MBR: Right.

EWS: So I went back home, and in two weeks I come back, and when I come back, my uncle told me—he says, "Now, whatever you do, don't let them send you to 400 Area." He said, "That place has got the office up there"—in the meantime, he had gone to work out there in automotive. He was working in automotive. And he says, "Whatever you do, don't let them send you to 400 Area. That's the [awfulest?] place down there you have seen, and that place smells terrible. It's got gas"—and I can't think of the name of it right now.

MBR: Like hydrogen sulfide, right?

EWS: Yes, that sulfur.

MBR: [unintelligible] that sulfur.

EWS: Yes, that sulfur.

MBR: Not [unintelligible].

EWS: Yes. It was awful. So as soon as I got to the employment office, they said, "Well, we got a shuttle that's going to take you to 400 Area." What am I getting myself into?

- MBR: [Laughs.]
- EWS: And I had taken my lunch with me, and I was so nervous, I couldn't eat my lunch, and it was in a little bag, and I took it, and I put it in the trashcan, and I sat there, and I sat there, and I got so hungry—and I went and got it out of the trashcan.
- MBR: [Laughs heartily.]
- EWS: I went on to the trashcan to get it out.
- MBR: [Continues to laugh.]
- EWS: I'll never forget that. But I ate my lunch and then the shuttle finally come and took me down to the area, and they introduced me to the supervisors down there and everything. I was 18 years old. I was so green. And all the supervisors was white. I guess they was probably in their early thirties or something, but you're 18 years old, you know—
- MBR: Right.
- EWS: —they was older.
- MBR: Right.
- EWS: They was a lot older. And was saying, "Yes, sir," "No, sir," "Yes, sir." And they was Yankees, and they weren't used to that, and they kept saying, "You don't have to say, 'Yes, sir' to me." But I couldn't help it because it was the way I was raised, because I remember they kept saying—they'd look at me so funny and they'd tell me something, and I'd say, "Yes, sir," "No, sir," you know? Anyway, they showed me around the lab and told me—you know.
- And so they assigned me to this one girl. Well, first of all they put me on shifts. I worked on days for a little while, just showing me around the labs and everything. Well, this was the only lab that was built then. It was the only one they had completed, was where the heavy water—making the heavy water for—
- MBR: The area, yes.
- EWS: And so the girl they assigned me to was on shifts, but she was on days that week I came in, and her name was Betty [Grimsfield?], and she's still Betty Grimsfield, and she lives in Augusta, and I still keep in touch with her. That's been fifty years ago.
- And anyway, all I did—she was supposed to be training me in this lab, to do this analysis, but all I did all day for four days was wash up her dirty glassware for her. But I didn't know any better.
- MBR: Right, right.
- EWS: And so I'd go in there and I'd wash glassware, wash glassware. That's all I did for four days was wash the glassware.
- MBR: You mean the laboratory beakers and things like that?
- EWS: Yes, yes, yes, glass—it was a lot of glass and beakers, and that's all I did for four days. And then after, they put me on shifts, and they put me with some people that trained me to do the different analysis in the different labs, and I realized, Well, she didn't teach me anything; I just washed glassware for four days. I don't know why I remember little things like that.
- MBR: [cross-talk; unintelligible]. Right, right.
- EWS: And I had some real good supervisors. The first night that I had to work midnight, I had never been up all night.
- MBR: Where did you live in Aiken?

EWS: [New Ellington?], in a trailer park.

MBR: You lived in a trailer park?

EWS: Yes,.

MBR: With your uncle or by yourself?

EWS: With my uncle.

MBR: Okay.

EWS: And I didn't have a car, but I got—

MBR: What was the name of the trailer park? Do you remember?

EWS: [No immediate response.]

MBR: You don't have to remember.

EWS: I know the man that run it was Mr. [Shelhouse?].

MBR: Okay. All right. So it was right in New Ellington.

EWS: Yes, right in New Ellington. It was not far from [Johnson's Crossroads?]. It was after the school.

MBR: All right, okay.

EWS: And I got a ride to work, and I came in—the first night I had to go to work, I felt so bad, and I thought, Well, now, I hope I'm going to be all right. I've never stayed up all night before, and I was so worried about it, and I felt so bad, and I got to work, and I got to feel worse and worse, and I went to the bathroom, and I threw up—on my first night, midnight. And I went in there, and I told my supervisor I couldn't hardly hold my head up, and I felt so bad because I hadn't been there for about two weeks, and I told my supervisor—I said, "I think I'm sick." And he felt on me, and I was burning up with a fever. Well, they sent me to medical, and they took my temperature and everything, and they called somebody to come take me home, and I had the flu.

MBR: Aw, no!

EWS: And I was in the bed for, like, four days, and I thought, Well, they're going to fire me.

MBR: [Laughs.]

EWS: I said, The first week I was on shift work, and I got sick. But they was real nice to me, and I won't never forget that. And if I had my friend here with me, Betty Johnson then, but she's Betty Waters now, she and I made it, and we were both 18. Now, she can tell you the name of all of our supervisors we had then. I can't remember them right now, but she does. I remember one was [Alan? Allen? Albert? Alfred?] "Al" Hungerford.

Anyway, we worked in 400 Area for a year, and then they told us about they was building this laboratory in F Area, and it was going to be real big and that's where they was going to have a radiation [room?]. They call them hot samples. They wanted to know if we wanted to transfer up there, and we could probably get a day job. And we said, "Sure."

We transferred up to F Area. Got there, and they were still doing construction work on the building. It was next to the canyon, [unintelligible] Canyon, that lab right next to the [unintelligible] Canyon.

MBR: Is it 772?

EWS: 772-D was the name of it. It was F Area, but the laboratory was 772-D. And we got there, and it was huge. I mean, you know, every time we'd turn around we'd get lost. When we went back to the lab, where they was building the lab, and they still hadn't put in the sinks in the lab and they was putting in

radio benches and they was putting in [glove?] boxes, and we just did these dummy samples—you know, went through them like they were hot samples, in practicing?

MBR: Right. Did you use a glove box?

EWS: Yes, we used a glove box, but it was a while till they got some in, but we didn't have any hot samples, we were just practicing. And we did this for about a year, I think, and then they got the sinks in and got the water connected up and everything, and then I think we'd been there at least a year before the first hot samples come through from the canyon. They had three HP guys, which was health physics, following the sample from the canyon to the logging it in and bringing it into the lab.

MBR: Did they carry it over? Do you remember?

EWS: Those pushcarts.

MBR: On the pushcart.

EWS: Pushcarts.

MBR: Okay, yes.

EWS: And, oh, it was just a big exciting. I remember that. Everybody was so excited. And they brought it into the lab, and Betty and I analyzed the first hot sample that was brought from the canyon.

MBR: This is Betty Johnson?

EWS: Betty Johnson Waters.

MBR: Waters, right.

EWS: And it was rated 700 MR.

MBR: Wow.

EWS: Which is nothing compared to what we did later on, was reading R's.

MBR: Right.

EWS: And so she and I worked there on shifts, and they put us on B shift. I don't know why—

MBR: What is B shift?

EWS: Well, there was three shifts: A, B, and C, and they put us on B shift.

MBR: That correlates to, like, a time during the day?

EWS: Well, it was rotating.

MBR: Oh, I see. I gotcha.

EWS: We worked days a week, and then you'd be off a couple of days, and then you'd work [unintelligible] for a week, and you'd be out two days, and then you start midnights, and you start midnights on Friday night and you work till the next Friday morning, and then you'd have four days off.

MBR: Thank God!

EWS: And we did that for well up until I got pregnant, and that was when they said—you know, you had to lay back to three months.

MBR: All women had to do that?

EWS: Yes. [cross-talk; unintelligible] they made you leave at three months. It didn't matter where you worked. And I was working in radiation, and that was before they had the lead-lined aprons that they let you wear when you do real hot samples, but the three months that I worked was the most critical in pregnancy, and that's when I had to work with some of the hottest samples that come through the lab, and then I had to leave after three months. And then after my babies was born, they said, "Well, we're not hiring women

back in the lab anymore. You can't go back to work out there in the lab." And they offered me a clerical job, and I said, "No, no thank you." And then after they told me this, about a year later they called me to come back to the lab, and that's when I went back, and it was just like time had stood still.

MBR: That's a riot.

EWS: It was weird.

MBR: [Laughs.]

EWS: I'll never forget it. It was just really weird how here sit the same patrolman. "Hey, Elsie." Went in and got to the lab. Same supervisor sitting in the same office. "Hey, Elsie." Well, all together I was in F Area for seventeen years.

MBR: That's a long time.

EWS: Yes. And all together, when I retired in '95 I had thirty-five years. I spent it all in the lab.

MBR: Now, I have to ask this because the last people I interviewed, they met—

EWS: Out there?

MBR: [unintelligible].

EWS: Well, I met my husband out there.

MBR: I was going to ask you. [cross-talk; unintelligible].

EWS: And Betty, the one I was talking about—she met her husband out there.

MBR: Oh, my goodness.

EWS: Yes.

MBR: Are they from—

EWS: Well, she's from Tennessee. She's from a little town called Lake City, which was near Oak Ridge, and that's how she found out about it because her aunt and uncle worked in Oak Ridge, and they transferred from Oak Ridge to here, and she came with them when she finished high school. That's how she came to work here. And her husband she met was from Johnston, South Carolina. He was working out there.

MBR: Was your husband from South Carolina?

EWS: No, he was from a little town in Georgia, [Littleville?], Georgia.

MBR: Did he start his career at Savannah River Site, too?

EWS: Well, he went to college first.

MBR: And then he came there?

EWS: Yes.

MBR: That's really neat, though. Now, women seem to have a better feel for this, or it seems to me when I talk to them—what was it like socially? Now, here you're an 18-year-old—

EWS: Oh, we had a ball. We had a ball. It wasn't anybody married or anything yet. Everybody on the shift was single. And there was about four or five women and about thirty men.

MBR: [Laughs.]

EWS: And in production, over in the canyon, it was all men. It was like 200 men worked over in the canyon in production, and they'd bring samples over to the lab, and there was, like, five women in the lab. Well, they knew all the women. And they was always, "Hey, Elsie. Hey, Elsie." And I didn't know any of them. And then later on, a lot later on, you know, like thirty years later, "I remember when you worked in F Area, and you were so snotty and you wouldn't speak to us." But the reason I wouldn't—

- MBR: [Laughs.]
- EWS: —is because these men would come over there and flirt with us and ask us out, and they were married men.
- MBR: Oh, oh.
- EWS: Some of them were married, and, you know, at first I was just real friendly with them, and—
- MBR: No, right.
- EWS: And then they'd ask you to go out, and then later on I find out they were married.
- MBR: Uh-uh.
- EWS: And so I quit [unintelligible] some of them, and they said, "I remember when you worked in F Area and you wouldn't even speak to me," and I thought, Yeah, I [unintelligible].
- MBR: [Laughs.]
- EWS: But anyway, we had a softball team—
- MBR: Oh, you did?
- EWS: And we'd get off from work—we'd get off work sometimes off the graveyard [shift] at eight o'clock in the morning and go somewhere and play softball, and then sometime we'd go home and we'd go to bed and we'd get up at two o'clock and go somewhere and go swimming. And I remember a few times that we'd get off from work at eight o'clock on Friday morning, off a midnight [shift], and go to the beach, and I'd be up all day and, you know, never go to bed.
- MBR: It's good being young, isn't it?
- EWS: Yes. And we'd get off a midnight, and we'd have—well, it's really five days if you count the Friday. We wouldn't have to go back until the next Wednesday on the four to twelve. I either go home with Betty, to her home in Tennessee, and we'd drive all day that first day we was off of work, or she'd go to my home and we'd spend two or three days and go back and just do things like that. And we'd get off of work sometime after four to twelve shift, we'd get off work at twelve o'clock, and on Whiskey Road, where Wal-Mart is now—well, before Wal-Mart was there, it was Palmetto Nursery. Before Palmetto Nursery there was the restaurant there called the Wagon Wheel, and the two big trees that's out there now were still there then. And we'd go to the Wagon Wheel after we'd get off work on four to twelve, and we'd eat and drink coffee for two or three hours, and then go home and go to bed. And we'd get up the next morning and go somewhere and go play softball or go swimming or something before we went to work that afternoon at four. We never—it was just like that all the time. And we had a great group of people we hung out with.
- MBR: It was a good time period, huh?
- EWS: Yes.
- MBR: Because you met your best friend here, too. It sounds like you and Betty became really—
- EWS: Yes, and we're still friends. Been friends ever since about '53. We still see each other all the time, yes.
- MBR: I think that's wonderful.
- EWS: And she was going to come today, but she started taking chemo. She had cancer, and the doctors don't want her to get out, afraid she'll get a cold. She's taking chemo. And I called her and wanted her to come today, and she said, "No, I better not get out." But she's got this box full of notebooks and things,

and she's to find out from Mr. Joseph if they wanted things like that, so that's the reason I didn't bring anything. I was going to find out first, so she'd look them up and maybe find them and bring them.

MBR: [unintelligible]

EWS: She would really be interested in the interview.

MBR: I'd be happy to—I can go to her house [cross-talk; unintelligible].

EWS: Oh, I wish you would, because—well, she has lung cancer, and she's—

MBR: Sure, yes.

EWS: But she's taking chemo now, but she could tell you a lot more stories than I could.

MBR: Oh, you've told, I think, great stories. I happen to know, for the record, that Elsie's sister is the room, and your name again?

JACKIE MBR: Jackie.

MBR: Jackie, okay.

J. MBR: live in Covington, Georgia.

MBR: Okay. Well, I live right past Conyers.

J. MBR: That's why we're neighbors.

MBR: Yes, yes. But that's the other laughter you hear at the table. I want to let the people know that.

Well, I think it's great—you give me a great—I can't imagine being 18—[cross-talk; unintelligible].

EWS: I had never been away from home.

MBR: I think you had a lot of courage [cross-talk; unintelligible].

EWS: And the first Christmas that I'd ever been away from home, I had moved. I was working midnights, the first Christmas, and I had to work Christmas, and I couldn't go home, and I cried for two days. And I had a little sister at home, and she just started school. She started school the first—when I graduated, she started school, and I have raised her—she was just like mine. And I [unintelligible].

MBR: [Laughs.]

EWS: It was a sad Christmas. I'll never forget that Christmas. And my uncle—they left. I was there by myself that first Christmas. I won't never forget it.

MBR: Did you have a car? I mean, how did you get to and from when you [cross-talk; unintelligible]?

EWS: No, I didn't have the car for a long time, and I just got rides. We had carpools, and people picked me up [cross-talk; unintelligible].

MBR: [unintelligible] from and—

EWS: And I paid them. They was people that was on the same shift.

MBR: Oh, I see, once you got to know—

EWS: The first carpool I was in, they were from [Banksburg?], and they drove from Banksburg every day, and they'd come by to pick me up.

MBR: Oh, that was good.

EWS: But, God, I'd hate to have to drive [unintelligible] to Banksburg. And they did it for years and years.

MBR: Yes. Were you happy to get out of D Area?

EWS: Yes.

MBR: Did it smell?

- EWS: Oh, I didn't tell you about that. The first—well, when I was down there on days, it wasn't too bad. It seems like the first time I was on a shift, I worked four to twelve, and we could go outside then from [unintelligible]. There was a door to, like, to that wall, to that side, and I had to run outside and throw up several times, and they told me—and we had these masks that we had to carry around with us in case they had a release, that we had to put them on, and we had them on a knob outside the doors. The first few nights, I got deathly ill. I had to run outside. I'd run outside and throw up and come back. Go out to that side door before I could get to the restroom. And they told me—they said, "You'll get used to it. You'll get used to it." And I thought, No, I'm not [unintelligible]. I would get so sick. And then they said, "When you can't smell it, that's when it's dangerous." Well, after a few weeks, it didn't bother me.
- MBR: Really?
- EWS: I kept thinking, I don't smell it. Maybe [Ms. MBR laughs; unintelligible].
- EWS: But you finally get used to it. I finally got used to it. I said, Well, I quit throwing up.
- MBR: That's good! [Laughs.] Well, did you have [med?], I mean [unintelligible]? I mean, you [unintelligible], it would be serious.
- EWS: Yes, and they had the canisters, you know, in the med, but we had to carry one if we went outside the building here, but most of the time we just had them hanging outside the lab.
- MBR: I gotcha. Now, when you did lab work, what did you do?
- EWS: Now, that's what I can't remember. We had a lot of different analysis, and I remember one of them was that we had—I can't remember the name of it now. Betty can tell you the name of it.
- MBR: Okay.
- EWS: I just can't remember the name of it.
- MBR: Well, don't worry. You just keep going.
- EWS: If she said it, I'd say, "Yeah, yeah, I remember doing that." But there was one analysis that we had that we had to run this material through all these glass pipes, and we did it with mercury, and it was the bowl about this big around [demonstrates], about this high [demonstrates], and it weighed about ten pounds. Wait a minute, maybe not that much, maybe six or seven pounds. Anyway, it was filled with mercury, and we had to lift it up and down, like this [demonstrates] to run this through the piping, and that was the first job they gave me. And I found out later on it was the worst job at the lab. It was the hardest job and the worst job in the lab. We had to sit down, like, lift—and I'd get tired and I'd move this arm up and down [demonstrates].
- MBR: [Laughs.]
- EWS: All night some nights, doing that, doing this analysis.
- MBR: Oh. That was hard.
- EWS: And I was so tired when I'd go home.
- MBR: Who explained to you what to do? You know, I mean, in terms of [cross-talk; unintelligible]?
- EWS: You know how they say learn for—
- MBR: Yes.
- EWS: You can't be worried, and [unintelligible] spilling on the floor would be running all over the floor.
- MBR: [Chuckles.] It's part of the learning [unintelligible], probably, no?

EWS: Yes. But I can't think of the name of it now, the analysis' name, to save my life. And we had three labs, with these different analysis in all the labs, and we had [unintelligible]. I remember we did a lot of [unintelligible] work. But I can't—

MBR: [unintelligible] spectrometers, right?

EWS: Yes, [unintelligible] spectrometers.

MBR: Right, right. Were you checking the purity of the heavy water?

EWS: Yes.

MBR: There. And then when you went over to F Area, you were actually checking the product, I guess.

EWS: Yes, that was that Pu.

MBR: Right, right.

EWS: The plutonium.

MBR: That's for your sampler? Oh, this has been great for—

EWS: But, now, my friend—now, she can tell you the name of our supervisors, the name of the analyses, and she can remember all that stuff, but I just don't remember some of it.

MBR: Well, you know what would be fun maybe—

EWS: But then I have another friend that lives in [Barnwell?] that I met after I went to F Area, and she took a lot more notes than I did. I mean, she was always writing. But, see, when we first went up there, they didn't have official procedures.

MBR: Oh, they didn't?

EWS: And we had to write our own procedures, and so I kept all those notebooks where I wrote procedures in. Now, that was what I was asking Mr. Joseph—they said, "Yes, they got dates on them." I said, "Well, I think I put dates on some of them." But, now, my friend that lives in Barnwell is named Claire [Creach?]. She was Claire [Bath?]. Now, she's got a lot more notebooks, and I'll get in touch with her and see if she's still got her notebooks. And she can tell you a lot of things, too. She can remember a lot of details. She's real good at remembering a lot of details.

MBR: Well, it would be kind of fun. Maybe if the three of you get together and do one interview.

EWS: Yes.

MBR: Because I think you would—if you're like my sister and I [sic; me], we feed off one another.

EWS: Yes. Another lady that come to work out there in the lab—she grew up in [Ellington?], and, oh, she used to tell us all these stories about Ellington—you know, when they moved everything.

MBR: Right.

EWS: And then she lived in Jackson, and her name is Edna [de Weese?], but she was Edna [McLean?], Edna McLean De Weese, and she grew up in Ellington, and she and I worked together a long time, and then—she can tell you a lot about Ellington. I used to love to hear her tell stories about Ellington before they moved [unintelligible]. And worked in 400 Area—I'll tell you another little story I won't never forget, is when I was moving out of the building?

MBR: Yes?

EWS: Out of Ellington—I mean, huge houses and buildings, big buildings on these big flatbeds, and some of them was moving on the train or they had a train that comes through there.

MBR: Oh, did some get moved by train too?

- EWS: Yes, they put some of them on the train.
- MBR: Wow.
- EWS: I don't know when they took the ones on the train, but they had some on these flatbeds that they was moving up to Jackson and New Ellington and different places, and some to [Beach?] Island, and got up one morning, and it was just real interesting. One of our supervisors took us, and we rode around Ellington [where? when?] they moved all the houses, and saw big, huge, beautiful homes and fruit trees and stores and cotton gins and post office and all kinds of stuff, and I thought—and they said they got to take all—and I just thought, Oh, that is so sad.
- MBR: Yes.
- EWS: But I went to sleep one morning. I got in the car, and I was so tired, and I leaned over like this [demonstrates], and I went to sleep, and we took off—and we hadn't even got out of 400 Area. Got to the railroad tracks, which was about five miles from the lab, and they stopped, and I thought I was at home, and I opened my eyes, and all I could see was the buildings. I thought, We're in somebody's driveway.
- MBR: [Laughs.]
- EWS: And it was house on a flatbed, and we had to wait until the house got by. And I thought we drove up to somebody's yard.
- MBR: [Laughs.] [unintelligible].
- EWS: We saw a lot of that that first year I was there, and that was 1953, moving a lot of buildings and homes. It was sad to see.
- MBR: Yes, sure.
- EWS: Because I said, Now, people live there. They raised families there, and they had farms and big, pretty homes and farms. Fruit trees, and had animals, horses and cows and all that stuff. All that had to go.
- MBR: Right. What a sacrifice, huh, on their parts.
- EWS: It was real sad.
- MBR: Yes.
- EWS: I thought about that a lot that first year I was there [unintelligible].
- MBR: You were a good 18-year-old then.
- EWS: Yes.
- MBR: You know what I mean?
- EWS: Yes.
- MBR: A lot of 18-year-olds aren't thinking—
- EWS: Yes.
- MBR: You give a different perspective because in 1950 Savannah River Plant is mostly white men.
- EWS: Yes.
- MBR: You know?
- EWS: Yes.
- MBR: And here, you're an 18-year-old.
- EWS: It's a lot of Yankees. They were all Yankees.
- MBR: [unintelligible]. [Laughs.]

EWS: I had lived—I was here in New Ellington for a year before I met the first original Aikenite.

MBR: No!

EWS: Everybody I knew was from somewhere except the lady I met from Ellington. But, now, I didn't meet her till I went to F Area, so that was a couple of years later.

MBR: [Laughs.]

EWS: The first year—I was here for one year before I met an original Aikenite.

MBR: Wow.

EWS: And that was after I transferred to F Area, and they started hiring a lot more people after it went hot. I keep saying [cross-talk; unintelligible].

MBR: Yes.

EWS: And they started hiring a lot more people, and they hired Richard Sullivan, and he still lives here in Aiken, and he was born and raised in Aiken, and he was the first person that I met. That was Richard from Aiken, and we're still friends. I still see him all the time.

MBR: That's nice. That's nice. When you got married, did you live in the Aiken area?

EWS: Yes.

MBR: You guys settled here.

EWS: Yes.

MBR: So both of you worked at the site.

EWS: Yes. Well, no, he didn't. I've been divorced a long time. He worked out there about, I don't know, maybe ten years, and we divorced and he left.

MBR: And then he left, so you stayed.

EWS: Yes. Yes.

MBR: How about your uncle?

EWS: Well, yes, he stayed, and he was working in the automotive department, when they took all the plant vehicles to be serviced?

MBR: Sure.

EWS: He did all the front-end alignment work, and he had this one booth, about as big as this—maybe a little bit bigger than this room—where they drew the trucks and the cars, the plant's vehicles, and he did all the front-end alignment. And he stayed in that same booth the whole time he worked at the plant.

MBR: Wow.

EWS: I think he worked about twenty-five years, and he retired, because he was, like—well, he was in World War II, so he was, like, his probably late thirties when he came to work out here, but he passed away about ten years ago, but he retired and moved up to Santee. But he's been dead about ten years now.

MBR: Wow.

EWS: But I lived with him until—

J. EWS: His name was Homer Wood.

MBR: Homer Wood, okay.

EWS: And I lived with him. Then I got a girlfriend, and we had an apartment together, and then I got an apartment by myself, and I had an apartment by myself and a car and it was like [when I married?].

MBR: You're a working woman, really, in that plant.

- EWS: Yes.
- MBR: Were there a lot of women? I mean, not in F Area, obviously, because—
- EWS: Well, all the women was in clerical.
- MBR: So they'd be up in A Area.
- EWS: Yes, or nurses. There weren't that many in the lab. There wasn't that many women in the lab. And all the women that was in the lab—in fact, I don't believe after we left 400 Area, there was very few women that stayed there, and then, you know, 400 Area didn't run much too longer. And there was just men down there then. They didn't have any women down there. And then they started hiring some more women, and they had a few women supervisors. I had one woman that—I didn't work for her, but she was Jane Hatcher. She lives in Augusta now, and she was the first woman supervisor. She was a chemist. I think she was a chemist. And all the rest of them were all men, white men. And I remember when they first hired the first black. I remember that. That's a long story. [Chuckles.]
- MBR: But really it was—really it must have been—
- EWS: You know, we just bent over backwards trying to accommodate them, because they told us, you know, "We're going to have some blacks in the lab."
- MBR: Right, right.
- EWS: This was—oh, this was in the mid sixties, I think.
- MBR: Okay. [cross-talk; unintelligible]. Right, right.
- EWS: Because that was Savannah. It was just white people in the lab. The only blacks out there was what they called service attendants. They didn't call them janitors, but that's what they were. They called them service attendants. And there wasn't many of them.
- MBR: No.
- EWS: There wasn't very many of them.
- MBR: Did they do anything with—well, if people were only janitors or service attendants, black people then, there probably weren't separate bathrooms and that sort of thing. Do you remember?
- EWS: Yes, yes. They had separate restrooms and separate lunchrooms. Sure did.
- MBR: Sure did.
- EWS: Yes, we had a big lunchroom, and it had about five or six tables in it—
- MBR: I was going to ask you anyway.
- EWS: Had a little room about this size with one table in it. But, now, they had what they call service [unintelligible], and I believe they just had two big shifts. They had two black men—I believe it was just two.
- MBR: So there were very few blacks there.
- EWS: We were real nice to them. I mean, you know, we were real nice to them, but they had their separate restrooms and they had the separate lunchroom.
- MBR: Right. Well, it was a very different society then, you know?
- EWS: Yes. There wasn't any black women out there.
- MBR: No?

EWS: They didn't even have a black nurse. If they did, I didn't know where she was. I didn't ever see her. There wasn't—no. Very few blacks. And, like I say, they were service attendants. Now, they might have had some black secretaries. I just don't remember.

MBR: Again, that would be, like, A Area probably.

EWS: Yes.

MBR: All right, the last two people come in, I said a lady's name, and they both said the same thing about the lady. There was a nurse there.

EWS: Dale Harvey.

MBR: Right.

EWS: I saw her at the twenty-five-year dinner this year. She was in World War II.

MBR: No! [Laughs.]

EWS: She was a nurse in World War II.

MBR: Oh.

EWS: And she's got some pictures of her. In fact, it was in the plant paper—not the plant paper, the Aiken—maybe it was the Aiken paper. Anyway, she had on shorts, and she was in one of the little huts or whatever in World War II. She would really be interesting to interview.

MBR: I want to talk to her about swabbing throats.

EWS: Yes.

MBR: I guess she was a—[Laughs.]

EWS: She was real good. She was real good. Everybody knew Dale. She was up in the 700 Area, and when everybody hired in, she gave a physical.

MBR: Oh, okay. Sure.

EWS: So you had to have a physical before they hired you, and you had to get a complete physical. I mean, it lasted two or three hours. And she gave everybody that was hired in a physical.

MBR: Wow.

EWS: And then when you'd go back to medical, most of the time you'd see her.

MBR: [Laughs.] Oh, I think that's [unintelligible].

EWS: And you had to get a physical every year, and you had to go up to 700. No matter where you was working, you had to go up to 700 Area to get your physical, and she worked days. And if she didn't give you your physical, you saw her. And I hadn't seen her in twenty years—

MBR: And you just saw her?

EWS: And I saw her at the twenty-five-year dinner, and she remembered me.

MBR: Oh, I think that's great.

EWS: Or she said she did.

MBR: Well, I think that's really neat.

EWS: But I wish—she lives in Aiken, and they got a farm. Her and her husband's got a farm. He was in World War II. He's [unintelligible].

MBR: He was here this morning.

EWS: Oh, he was?

MBR: That's right, and I didn't make the connection at all. That's why—

EWS: Oh, she didn't come with him?
MBR: No, no, no, he came—
EWS: Oh, I'll bet you he could tell you some tales.
MBR: Right.
EWS: But he was in World War II.
MBR: Very nice man.
EWS: Yes, you need to interview her. She's real nice, and she's attractive, real petite.
MBR: Aw.
EWS: Yes. She would be interesting to interview. But I didn't see him. I must have missed him, but they have—
MBR: [cross-talk; unintelligible] real early.
EWS: They have a farm, and it's somewhere between New Ellington and Aiken. I'm not exactly sure where it is, but she would be real interesting to interview.
Now, how long are you going to be doing this?
MBR: Till two o'clock today. But we'll be doing more [cross-talk; unintelligible].
EWS: Okay. Well, I want to tell my friend, Claire Creach—she lives in Barnwell, and Betty Waters that lives in Aiken, and I want to contact them and see if they'll come give you an interview, because they can tell you a lot more. They could probably tell you more things about the plant than I could.
MBR: Well, Elsie, what I could do is—I mean, I'm going to turn this off and say thank you for that, for speaking, and great—

END TAPE